



TECHNIUM
SOCIAL SCIENCES JOURNAL

Vol. 17, 2021

**A new decade
for social changes**

www.techniumscience.com

ISSN 2668-7798



9 772668 779000

On the Non-existence of English ‘Prepositions’ and ‘Complementisers’

Awasha Atiega

EAP Tutor at University of Central Lancashire, United Kingdom

amatiega@uclan.ac.uk

Abstract. The categories Preposition and Complementiser are distinctive in the literature and several diagnostic criteria have been put forward to identify the two categories in question. However, their existence was called into question and the current investigation showed that the distinction normally drawn between these two classes did not seem to work. That is, previous researchers including traditional grammarians seem to take those two-word classes for granted as the criteria set to define and distinguish them were problematic and did not succeed in defining them. The behaviour of most of the many items classified as prepositions and/or complementisers in some major grammars of English were tested with regard to a range of syntactic factors. On the basis of this, at least 59 distinct classes were formed and finally possible taxonomies of these 59 categories were also structured.

Keywords. complementiser, construction grammar, preposition, taxonomy, word classes

1. Introduction

Since the syntactic problems posed by the categories of prepositions and complementisers are yet far from being resolved, I will reconsider the characteristic properties discussed in the previous research and unsuccessfully employed to identify these two categories and show that there is a great deal of complexity which cannot be handled by positing two classes. Thus, I will argue for an alternative view and seek more satisfactory classification via an examination of the syntactic properties of a large sample of words claimed to belong to the two categories under consideration.

The remainder of this paper is structured as follows. Section 2 and 3 present the syntactic properties of English prepositions and complementisers and then section 4 proposes a first attempt at an argument that the two categories in question do not exist. Section 5 gives a brief introduction to a constructional framework which will be adopted in this study to explain the findings of the current study. Section 6 reviews an exhaustive account of the method used to obtain the data required for the project as well as the sources of data consulted. Section 7 proposes new classes which replace the existing categories of prepositions and complementisers and discusses how such a classification affects the theory of grammar. And finally, section 8 provides the concluding remarks of the paper.

2. Approaches to English prepositions¹

2.1. On syntactic criteria of prepositions

2.1.1. NP Complementation

This criterion corresponds to situations where a preposition is followed by an NP, which characteristically serves to express a spatial relation between the preposition and its complements (Pullum & Huddleston, 2002: 603). This syntactic feature captures the traditional mainstream view of English prepositions, where it is used to distinguish them from English complementisers (Ballard, 2007: 44; Radford, 1997: 523). That is, it has been argued that the former selects nominal complements (cf. de Smet, 2009; Haegeman & Guéron, 1999; Huddleston, 1984; Huddleston 2002; Snider, 2010), whilst the latter selects clausal complement (Huddleston, 1984; Quirk et al., 1985). Note the examples in (1–2), where *with* and *if* from a standard point of view are a preposition and a complementiser respectively.

1. I am here *with my friend*.
2. He will find her *if he goes back*.

This ‘NP complement’ criterion is also not beyond criticism by several authors, such as Pullum and Huddleston (2002: 600). They argue that this criterion only identifies what is commonly recognised as prototypical prepositions and complementation cannot be reliable evidence to identify prepositions (Huddleston & Pullum, 2002). From their point of view, the absence or the presence of the complement should have no bearing on the classification of the headword. In comparing prepositions with the open word classes of nouns, verbs and adjectives, they remain classified as such irrespective of the different complement types the open class syntactic items take (Aarts, 2011; Pullum & Huddleston, 2002; Weber, 2012).

Despite the plausibility of the argument, complementation should not be neglected completely, however. My chief contention is that complementation can also be a significant factor in defining the word class of some syntactic items. English auxiliary verbs are categorised on the basis of the form of the complementation they select. They have been classified into different classes accordingly (Falk, 1984; Flickinger, 1987). This is illustrated in (3).

3. a. If I *can help* further, please do not hesitate to contact me ... [modal verb]
[BNC: A00 78]
- b. Tony *has been* unwell over the weekend. [BNC: A00 376] [perfective]
- c. Although he *is suffering* from a type of septicaemia, he *is* [Copula]
clearly *having* a good spell. [BNC: A00 395]

2.1.2. Right/Straight Modifiers

Modification by *right* or *straight* is an additional criterion that has been set to define the category Preposition. It is widely assumed that prepositions, but not adjectives and verbs, can be modified by *right* or *straight* in English (Fabb, 1994; Hirao, 2014, 2015; Radford, 1997; Rauh, 1993). The contrast is illustrated in (4–5).

4. a. *They were right enjoying themselves. (VP)
- b. *I believe the employees to be right *trustworthy*. (AdjP)
- c. *The project was carried through right *successfully*. (AdvP)

(Pullum & Huddleston, 2002: 606)

¹ My use of prepositions includes postpositions throughout this paper.

5. a. There was a movie going on *right under* his nose and he didn't even know. [BNC C86 771]

Although it is traditionally considered as a valid criterion, several authors (e.g. Lobeck & Denham, 2014) have challenged its validity to identify the class Preposition. There are several syntactic items claimed to be prepositions but they cannot co-occur with such adverbs. The examples are shown in (6).

6. a. *A man *right/straight of* great courage.
b. *You can attend the lesson *right/straight without* me.
c. *I run *right/straight for* twenty miles.

This property from my perspective seems to be diagnostic rather than criterial. Any syntactic item from the closed class can be modified by *right/straight* must be a preposition, but not vice versa; any preposition must be modified by *right/straight*.

3. Approaches to English complementisers

3.1. Identifying criteria of 'complementisers'/'subordinators'

3.1.1. The mainstream traditional view

Following the general trend of views of traditional grammarians (e.g., Ballard, 2007, Lobeck & Denham, 2014; Quirk *et al.*, 1985), complementisers characteristically are words used to introduce clausal complements. *That* and *whether*, for instance, are considered complementisers because they all allow clausal complementation (Fiengo, 1980; Hudson, 1995). See (7) for illustrative examples.

7. a. I think *that* it's going to stop raining.
b. I wonder *whether* it's going to stop raining.

(Hudson, 1995: 41)

The lexical items which select both nominal and clausal complements, such as *before*, cause problems for the traditional account. However, to solve this issue, they have been analysed based on their complementation. They are prepositions when they select NP complements or complementisers when they select clausal complements. This is illustrated in (8).

8. a. The students bought the book *before the course started*.
b. The students bought the book *before the beginning of the course*.

After a diligent investigation of the range of complements some complementisers take, it becomes evident that this generalisation needs revision. The serious weakness of this traditional view lies in the fact that the type of clausal complements has been left unspecified. Is the clausal complement a finite clause without *that* as in the case of *if* in (9a), or with *that* as in the case of *except* in (9b), a subjunctive clause as in the case of *that* in (9c) or a small clause² as with *with*? Does this kind of complementation include small clauses with overt subjects and predicates? Are they all complementisers as they all have clausal complements? If the answer is yes, what would the classification of *on* and *with* in (d–e) be? Do they remain classified as prepositions

² (a) Small clauses I assume throughout the paper is the relations that occur between a subject and predicate where the subject could be raised to the subject or object of the matrix clause and the predicate could be of verbal or non-verbal.

(b) I follow the syntactic conventions here for the analysis of small clause complements; SC stands for 'small clause', S stands for 'subject' and Pred for 'predicate' (Citko, 2008).

as commonly recognised or are they best analysed as complementisers because they select clausal complements in these instances?

9.
 - a. I am asked if I can be on standby if *transport is needed*? [BNC A00 378]
 - b. I don't know the name or address except *that it is a club of some sort*. [BNC A6V 318]
 - c. The board recommended that *the motion be passed immediately*. [Google web]
 - d. He drops the script and hops about with [[SC [S *hands*][*in his armpits*]], going 'Ouch!' [BNC A06 1033]

3.1.2. *That*-clause complements

Dubinsky and Williams (1995: 126) propose that temporals, such as *after*, *before* and *while* tend to differ from nontemporals, such as *without*, *despite* and *about*, and they are complementisers whenever they occur before a *that*-clausal complement, as shown in (10).

10.
 - a. John left *after* I told him to.
 - b. *John left *after that* I told him to.

(Dubinsky & Williams, 1995: 126)

Their evidence comes from their observation that in certain southern dialects of American English, nontemporals can select a tensed clausal complement and the complementiser *that* can optionally occur at the surface. For the same speakers, it is impossible that temporals occur with an overt *that*, as demonstrated in (11). This has led Dubinsky and Williams (1995: 126) to the conclusion that the temporal element *after*, for example, is not a preposition, but a complementizer, which is attributed to their assumption that two complementisers do not co-occur.

11.
 - a. %They never came to church *without (that)* they brought their Bibles.
 - b. They came to church *after (*that)* they read their Bibles.

(Dubinsky & Williams, 1995: 126)

This is also true in the case of *because*, for instance, but what is intriguing is that *albeit* which syntactically does not seem to behave as a preposition. See the examples in (12) below.

12.
 - a. We are seeking to find out what local people want, *because (*that)* they must own the work themselves. [BNC: A00 184]
 - b. *Albeit* that they're very good guidelines, at the end of the day it's still up to individual to decide whether they adhere to them or not. [BNC: A7F 272]
 - c. Friday was bright *albeit* the wind was somewhat stronger, and it was colder. [BNC GXA 975]

3.1.3. Complementation is irrelevant

For Huddleston (1984, 2002), the distinction between the categories Preposition and Complementiser remains maintained, but the former extends to include more syntactic items than usual. From his perspective, the category 'Subordinators', which is a term used instead to refer to complementisers, includes only three items, namely *whether*, *if* ('whether') and *that*³ (Huddleston, 2002: 1011). They are traditionally assigned to the same class as, for example,

³ I will take for granted that that in this paper, *that* always refers to the so-called complementiser *that*, as in *I doubt that she can do it*, as opposed to demonstrative *that* as in *That is for you*.

although, unless, while, after, before and *since*. The view Huddleston takes is that the behaviour of these three words is grammatically different from the other items claimed to be complementisers. Therefore, Pullum and Huddleston's (2002) argument, which originates with Jespersen (1924), is that any item apart from these three should be analysed as a preposition heading prepositional phrases with clausal complements. Their motivation for such a generalisation lies in their observation that the items which belong to the category Preposition can function as non-predicative adjuncts. Therefore, *because* in (13) is analysed as a preposition and not a complementiser from their point of view.

13. They cancelled the match *because* the ground was too wet.

(Huddleston, 2002: 1016)

Once is another special case to discuss. Surprisingly, it has been analysed by Culicover (1999: 81–82) as a category in its own right despite the fact that it introduces a tensed clause. He ascribes his argument to the fact that *once* and the remaining complementisers ('subordinators' in his terms) do not appear to behave alike⁴ in terms of its syntactic distribution.

4. Questioning the categories 'Preposition' and 'Complementiser'

Libert (2017) and Liu (2014) state that the category Complementiser is an ill-founded class and grammarians are always in disagreement on its syntactic status and its members. Libert (2017: 18) states that for some researchers, this term is a modern or generative synonym for 'subordinating conjunction'. This is also supported by Carnie (2011: 46), who says that even "[i]n traditional grammar, complementisers are sometimes known as subordinators or subordinating conjunctions."

Hudson (2000: 14) also presumes that the name itself suggests uncertainty about the distinctive features of this class in general and its members in particular. Hudson (1995: 47) concludes that complementisers do not have a distinctive and shared characteristic and "... the most conservative position is to leave [words belonging to such a word class] unclassified." This goes hand in hand with Libert's (2017) statement that there is no clear indication by some authors about what elements belong to this category and this is possibly because they have taken it for granted. Along related lines, in recognition of the fact that all the criteria put forward by Radford (1997) are highly challenged and probably there are no generalisations which can be applied to all members of the syntactic category in question, Hudson (2000) strongly claims that there is no such category called Complementiser and any syntactic element which might be claimed to belong to this category should be treated as unique ("syncategorematic") (Hudson, 2000: 14).

A similar line of argument is made for the category Preposition. The question that arises as far as English prepositions is concerned is whether there is one property that the majority of prepositions share or are there a set of criteria which any element categorised as a preposition should have? The literature apparently has made no attempt to address this question or come up with a better justification of the category under consideration. All the attempts made to identify the category Preposition as a distinctive class are flawed and it seems to be taken for granted. All the syntactic criteria set to identify prepositions and complementisers appear to account for probably superclasses or subclasses of the so-called prepositions and complementisers, but not the whole set.

Therefore, rather than assuming the dichotomy between complementisers and prepositions, it is interesting to look in more depth at the behaviour of each category and

⁴ Following Culicover (1999), a distinction has been made between concessive *while* and temporal *while*.

subclassify the syntactic elements of each category accordingly and this has been set as the main aim of the current study. These two categories have been discussed here and there in the literature, but, as far as I know, a very comprehensive sample of data has not been explored. A thorough analysis of almost all the prepositions and complementisers will either corroborate and extend the analysis presented in the literature or refute and reject it. This study will also adopt some aspects of CxG to analyse the results of the present study.

Loosely speaking, there are three categories that can be included under a more general category named as ‘prepcomp’, which is a novel term created for the purpose of this study to refer as neutrally as possible to all the syntactic items that belong to both or the two categories in question. I will use the common term Preposition to refer as generally as possible to any syntactic item that has been classified as a preposition and Complementiser to any classified as a complementiser. However, the term ‘prepcomp’ will be unbiasedly used afterwards to refer to all the syntactic elements classified in the existing research as prepositions and/or complementisers. I will not use the traditional terms except when referring to a previous classification. This is because the traditional terms are already laden with descriptive and theoretical claims which I completely reject.

5. Theoretical framework

5.1. Definition of CONSTRUCTION

CxG is organised around the notion of GRAMMATICAL CONSTRUCTION (Davidse, 2000; Fillmore et al., 1988, 2012; Fried & Östman, 2004; Hilpert, 2014; Patten, 2013; Traugott, 2008). This semantically corresponds to the Saussurean’s definition of a sign. A construction within the constructionist framework is defined as a conventional inseparable learned pairing of form with some kind of meaning/function (Aarts, 2007; Barðdal et al., 2011, 2012; Bergs, 2010; Birner & Ward, 1998; Boas, 2011; Fried & Östman, 2004; Lakoff, 1987; Masini, 2005; Michaelis, 2004; Michaelis, 2012; Taylor, 2012; Wierzbicka, 1988). In the opinion of Croft (2001), grammatical constructions are like the lexicon in other syntactic theories; they consist of pairings of form and meaning. Lexical items such as *cat* are conventionally meaningful symbolic units, which are also explained under the traditional informal notion of ‘construction’ (Michaelis & Lambrecht, 1996).

Construction grammarians emphasise the assumption that constructions rather than words are the building blocks of syntactic analysis (Goldberg, 1995; Sag et al., 2012). The term ‘construction’ has been used at least informally in much of the linguistic literature, most notably in descriptive grammar, to refer to any specific, recurrent grammatical pattern. For example, linguists often speak of possessive constructions, partitive constructions, and serial verb constructions (Francis, 1999).

Constructions contain either constants or variables (Goldberg, 2003: 220). The former refers to the constructions that “their make-up is (more or less) fully specified” and the latter, by contrast, “are syntactic patterns dedicated to semantic and pragmatic purposes [and] ... can serve as host to” the former (Fillmore et al., 1988: 505–506). The elements in the LET ALONE construction, for instance, are constants (*substantive*); those in the DITRANSITIVE and RESULTATIVE constructions are variables (*schematic*) (*ibid.*). Some constructions are a mixture of both, for example, the V NP WAY construction (Jackendoff, 1997: 534) and the WHAT’S X DOING Y? construction (Kay & Fillmore, 1999: 2). With regard to how a construction is characterised, it is captured by its parts and their configuration. However, those parts are not selected randomly. There is a need to appeal to the semantics of the construction. To illustrate the point, in double object constructions, for instance, which can be manifested by the schema [NP1 – V – NP2 – NP3], the main verb does not take three random noun phrases. Rather the

syntactic schema is semantically supplemented by items which instantiate its parts (Taylor, 1998: 178).

6. Outline of the method

This study is a survey of almost all of the English functional words that have been recognised as prepositions and belong to the category Preposition and/or Complementiser from three authoritative sources (namely, Liu, 2014; Pullum & Huddleston, 2002; Quirk et al., 1985). It also aims to reconsider the actual evidence regarding the syntactic status of the two categories in order to formulate a descriptive and theoretical alternative to the existing classifications. From the examination of the evidence, the argument builds up to two main claims, one relating to the analysis of those words, and the other to its theoretical implications.

6.1. Listing the prepcomp words

While previous studies have analysed English prepositions and complementisers using a limited sample of syntactic elements, the original element of this paper lies in the investigation of a collection of more than 150 of what have been claimed as prepositions and/or complementisers in the existing research (see Appendix 1 for the sample of these syntactic items). They have been gathered mainly from Liu (2014: 56–59), Pullum and Huddleston (2002: 598–661/1011) and Quirk *et al.* (1985: 297–338/727). Of course, this is not to say that they are the only sources of usable prepositions and complementisers, only the most clearly delineated in terms of their inclusion of the syntactic items in question.

The prepcomps whose syntactic structure is determined by their semantic meanings and included in the current study are listed in Appendix 2. No attempt, however, has been made to include every single meaning of the prepcomps due to space restrictions.

For a simpler procedure, words that are derivationally similar have been grouped together because as a result of an initial investigation it was found that they are syntactically alike (Pullum & Huddleston, 2002: 614). All the following syntactic items have been conflated in the current investigation:

- X-WARD(S): *forward(s), backward(s), downward(s), upward(s), outward(s), inward(s), homeward(s), northward(s), southward(s), eastward(s), westward(s), leftward(s), rightward(s), skyward(s), heavenward(s), seaward(s)*
- N.S.E.W.: *north, south, east, west*
- X-STAIRS: *upstairs, downstairs*
- X-HILL: *uphill, downhill*
- X-STAGE: *upstage, downstage*
- X-STREAM: *upstream, downstream*
- OVER-X: *overseas, overboard, overhead, overland*
- UNDER-X: *underfoot, underground*
- X-DOORS: *indoors, outdoors*

There are some syntactic items excluded from the current study because their syntax is far beyond the scope of the current study. Comparative prepcomps such as *than*, *(un)like* and *as* ('like') have been excluded as their complementation always involves obligatory reduction (Huddleston & Pullum, 2006: 212). Note the examples in (14). The finite clause *as it is usual for her to stay* is left implicit in (14a). The complement of *promised* in (14b) also is not overtly expressed. In (14c) too, *than we had expected* remains unexpressed.

14. a. She didn't stay as long *as* usual.
b. You did not meet us at the airport, *like* you promised.
c. She arrived earlier *than* expected.

(Huddleston & Pullum, 2006: 212)

6.2. Listing the syntactic characteristic properties

Internal syntax

The traditional classification was based on the kind of complement that the members of the two categories in question take. This includes various syntactic configurations that are embedded as complements of the syntactic elements in question, hereafter referred to as 'internal syntax'. The internal syntactic properties investigated in this study vis-à-vis the precomps are listed in Table 1.

Table 1. Internal syntactic properties

Internal syntactic property	Example
NP complement	It is <i>in my bag</i> .
Prepositional complement	He discouraged the use of books, <i>except for research work</i> .
Zero complement	Jill is <i>upstairs</i> [___/Ø].
Adverbial complement	He has been working in this company <i>until recently</i> .
That-clause complement	<i>Given that conflict is inevitable</i> , we need to learn how to manage it.
That-less clause complement	<i>Provided you pay me back by Friday</i> , I'll lend you the money.
Is topicalisation permissible?	<i>Because strict commands like these</i> , he had to obey, he hated being in the army.
Small clause with an unraised subject with a verbal predicate	He wasn't happy <i>about me being blunt</i> .
Small clause with an unraised subject and non-verbal predicate	The children were wandering around <i>without any clothes on</i> .
Small clause with a null/raised/ not obviously raised subject and a verbal predicate	She has been looking <i>at selling her summer house</i> .
Small clause with a null/raised/ not obviously raised subject and a non-verbal predicate	The evening was very pleasant <i>albeit very quiet</i> .

External syntax

'External syntax' refers to the functions of syntactic items within a given syntactic construction. The significance of the external syntactic properties of syntactic items has been pointed out by Taylor who notes that "[t]he attributes that syntactic tests diagnose have to do, in many cases, with the ability of an item to occur in certain kinds of syntactic environments, i.e., to function as part of syntactic constructions of various kinds" (1998: 185). The external syntactic properties considered for the examination of the functional words under discussion are all listed in Table 2.

Table 2. External syntactic properties

External syntactic property	Example
Measure phrases modifiers	He saw her <i>three hours before</i> the exam.
<i>Right/Straight</i> modifiers	He set off <i>right after</i> midnight.
Particle shift	a. They took <i>away his gun</i> . b. They took <i>his gun away</i> .
Predicative complement of the verb <i>be</i> in raising constructions	He <i>is downstairs</i> .
Predicative complement in resultative-like constructions with verbs such as <i>put, find</i> and <i>see</i> ⁵	I found <i>him in bed</i> .
'NP'-like distribution	He emerged <i>from behind</i> the curtains.
Non-predicative modifier ⁶	<i>Since she came to visit</i> , we haven't met.
Postmodifier of NP	They built <i>a house with a flat roof</i> .

6.3. Selection of appropriate textual data

This study has used a mixed method to gather data. It has relied mainly on two corpora as sources of data. The advantages of a corpus-based approach are widely recognised (Chafe, 1992; Leech, 1991) as it contains naturally occurring data, not to mention the speed and accuracy of investigating data (Meyer & Nelson, 2006). Any cases which cannot be backed up from these research tools have been marked with an asterisk [*] (see Appendix 3). Let us start with an introduction to the main research tools adopted for this study.

6.3.1. Corpora

British National Corpus (BNC)

The British National Corpus (BNC) is a 100-million-word collection of samples of written and spoken language from a wide range of sources, designed to represent a wide cross-section of British English from the later part of the 20th century, both spoken and written. The latest edition is the *BNC XML Edition*, released in 2007.

The choice of the BNC in particular is inspired by the fact that there are some instances encountered in the process of gathering the data that are restricted to the British variety of English only, such as *gone* ('past') in (15–16) (Pullum & Huddleston, 2002: 611).

15. It was *gone* half past five. [BNC: FNU 749]
16. It was *gone* midnight, cold and autumnal, and they shivered in their denim jackets. [BNC: A03 495]

⁵ The syntactic configuration of the constructions of small clauses have not been without controversy (Chen, 2005). However, the sequences after the verb such as *found* in the illustrative example have been considered small clauses under the analyses provided by several authors (cf. Chomsky, 1981; Chung & McCloskey, 1987; Safir, 1983; Stowell, 1981; Snyder, 2001).

⁶ I have used the less technical term 'non-predicative modifier' replacing the 'non-predicative adjunct' criterion suggested by Pullum and Huddleston (2002) as an umbrella category to include, for instance, adverbials, as in *Although he was sick, he was able to make it*, as well as directional phrases, as in *The ship came abreast of us*, on the ground that the latter do not seem to be syntactically equivalent to the former. the positioning of *although* in such examples does not really matter, but not in the case of *abreast* with a non-topicalised sense. This is illustrated in (a–b) below.

- a. *Although he was sick, he was able to make it*. OR *He was able to make it although he was sick*.
- b. *The ship came abreast of us*. But not **Abreast of us, the ship came*. (And Rosta, personal communication)

Corpus of Contemporary American English (COCA)

COCA is a 400-million-word collection of texts evenly divided between spoken, fiction, popular magazines, newspapers, and academic journals. Recent updates were in 2017. The motivation of the selection of this corpus is threefold. First, it is of its enormous size. Second, there are some cases which are primarily limited to the American variety of English. *Out* is a case in point; *out* has to select an NP complement only in American English (Pullum & Huddleston, 2002: 639). Third, the BNC has been described as a ‘static’ corpus, which means it has not been updated since it was first created. COCA, on the other hand, has been described as ‘dynamic’, which means that new texts are constantly added to the corpus (Davies, 2010: 449). I have relied heavily on corpora tagging software to accurately test the characteristic features of the prepcomps. The data collection procedure has consisted of software queries to investigate these features. See Appendix 4 for the searches run in both corpora, which complement each other. That is, the results which cannot be obtained from the BNC were searched in COCA. Concordances were also manually sorted when investigating the usages of the prepcomps as many irrelevant hits were encountered within almost in each search conducted.

Due to time restrictions, only a total of 200 data were examined per corpus and for each feature and the “show in random order” option in the BNC was also used but not in the case of COCA because, as far as I am aware, there is no such function available in it. In every case where the concordance lines of the key items are below 200, all of the lines have been investigated for a given property. Illustrative examples gathered from the corpora have been marked either with [BNC] or [COCA] in the appendices. The section and line number of the examples listed will be stipulated after each example.

6.3.2. Google web

Google search also offers an unusual amount of data. One extremely useful feature when exploring the data for some of the syntactic properties examined that do not exist in the primary sources above is typing sequences of words in the site between two inverted commas “_” and Google only returns results with the sequences of words that match the sequences specified. Google search engine was also consulted when initial research in the current study was conducted. The examples gathered using this method have been marked with [Google Web].

Having discussed the use of Google Web for gathering data for the current study, it is worth mentioning its limitations. First, the queries made by the researcher were selective and specific. Second, it does not allow users to use part-of-speech tagging (Kilgarriff, 2007). Furthermore, the texts which make up the web-as-a-corpus are unknown. Finally, it does not annotate the data with the authors of the target texts are and whether they are native speakers or not and if so of which variety. Anyone can publish on the internet without passing the content to an editor.

6.3.3. Secondary sources

There are very few cases where the data have been collated from secondary sources. This was solely when an example is encountered in the literature, but no similar examples were found in the first 200 examples collected from both corpora or the Google Web. By way of illustration, the example with *but* when it means ‘exception’ as in *It never rains but it pours* was only encountered in Pullum and Huddleston (2002: 971) and the example of the purposive *that* when it functions as non-predicative modifier; *Give me one look, that I may see his face so beautiful,*

was adopted from the Oxford English Dictionary (OED). Such examples adopted from secondary sources can be known from their references to these sources.

6.4. Identifying the prepcomp classes

The above mentioned 19 criteria and the 186 syntactic items investigated in the current study determine a 19×186 chart. The columns represent the syntactic criteria, and the rows represent the list of the precomps with examples of unquestionable grammatical cases and asterisks for those ungrammatical ones (see Appendix 5).

Words that have exactly the same distribution have been merged into a single group. This method is supported by Harris (1951 cited in Rauh, 2010) for the identification of classes and the resulting classes from the present method are described as ‘distribution classes’, ‘substitution classes’ or ‘position classes’. The classification of *hear* and *tear*, for instance, as verbs is an example. That is because they substitute for the same environments as in *I’ll __ the bell* and *I’ll __ the paper* respectively. If a prepcomp does not fit in any of the environments or only into some, then this word is excluded from the list and a new list is begun, which is then extended following the same procedure. The numerous resulting classes differ in size, some have many members and even have even one member. This also leads to assigning homonyms to different classes. This practice is also supported by Redington *et al.*’s (1998: 437) general statement that “[t]he more similar the words’ distributions [...], the more likely that they are members of the same category.” Each group of these represents a word class in its own right and all its members share the same internal and external syntax relative to the chosen properties. This stage was, of course, after the initial groupings of all the precomps which are derivationally related words, such as *backward(s)* and *downward(s)*, that are syntactically identical in all respects. New category names will be introduced and will be called Class 1, Class 2, Class 3 and so forth and will be labelled with one word representing each of them. The intention in using this neutral notation is to prevent confusion with the traditional labels and to show that they are of a different kind despite the similarities which might be held between some of the resulting classes and what is traditionally classified as Preposition, Complementiser, Adverb for example.

7. Categorisation of precomps

7.1. Classes of precomps

This section presents and discusses the syntactic facts gathered previously and introduces a new system of classification of the syntactic elements widely described as prepositions and/or complementisers. It also aims to answer the question: what does the picture of the new classification look like and how can the findings be explained in the light of a constructional framework?

Any syntactic analysis necessarily involves two intertwined questions that need taking into account: the methodological and theoretical questions (Croft, 2001: 9–10) listed in (a–b) respectively.

- (a) Is there a general, language-universal method for justifying the existence in a particular language of the syntactic elements – categories and relations – that are the basic units of syntactic theory?
- (b) What is the nature of the grammatical knowledge that the speaker has in his/her head, and how should it be represented?

Due to the inadequacy of the semantic criteria (Pullum & Huddleston, 2002), the distributional method which relies on syntactic characteristics as criterial in defining syntactic categories has been adopted. The classification of the prepcomps, which are presented in mini tables in Appendix 6, is arrived at in a similar way. The rows represent the prepcomp classes. Each class contains prepcomps which share the same syntactic distribution. That is, they are conflated in single rows and labelled in small capitals representing the name of the category in question. The columns, on the other hand, represent the criterial constructions which were taken to identify the new categories with illustrative examples of these properties.

The cells of the table contain either the + or the - signs to indicate that a particular criterion either does or does not characterise the item in question. According to the distributional analysis method, the pattern of occurrence and non-occurrence of each word in a row is known as the distribution or behaviour of the members of each category (Onnis & Christiansen, 2008). Once the distribution of a given word is determined, the syntactic category to which it belongs can be determined (Haegeman, 1994).

The result of the current classification is 59 classes of prepcomps, as shown in Appendix 6. The opaque names, such as “Class 34” usually given to the classes despite their privilege of avoiding unwanted connotations with Latin and English have been criticised for being very hard to remember. Therefore, to avoid such a problem each class has been associated with one of its members with small capitals.

The high number of classes is the result of an investigation of the syntactic behaviour of each individual word. This provides support to the claim made in this paper that the classification of what is commonly recognised as prepositions and/or complementisers is too generic. This is supported by Taylor (1998) who declares that the small number of categories generally tends to obscure deeper problems associated with these categories.

There should be no limit on the number of the members of given syntactic categories. Jacobsson (1977) and Culicover (1999), for instance, also place no limit on the number of members which belong to a given category. *Instead, ago, once* and *notwithstanding* have all been claimed as categories in their own right, as their syntactic behaviour seems to differ from any other existing syntactic item. For consistency and clarification’s sake, each characteristic property will be illustrated by a separate example although some examples can demonstrate more than one property of a given class. By way of illustration, the sentence *He walked 515 feet upstairs* can illustrate the ‘zero complement’ property, the ‘measure phrase’ property and the ‘non-predicative modifier’ property of the syntactic items belonging to the X-STAIRS class. However, separate examples will be provided for each property. Below is the summary of the prepcomp classes with their syntactic properties which are listed in the following alphabetical order.

- A: can have NP complement
- B: ‘prepositional complement’
- C: can have no complement
- D: can have adverbial complement
- E: can have *that*-clause complement
- F; can have *that*-less clause complement
- F* can have the infinitival *for* complement
- G: can have topicalisation
- H: can have small clause complement: overt subject & not *-ing* predicate
- I: can have small clause complement: raised subject & *-ing* predicate
- J: can have small clause complement: raised subj & not *-ing* predicate
- K: can occur with complement with correlative *or*
- L: can occur with measure phrase



- M: can occur with *right/straight* modifier
N: can undergo particle shift
O: can be predicative complement in RAISING constructions
P: can be non-predicative modifier

	A	B	C	D	E	F	F*	G	H	I	J	K	L	M	N	O	P
ABOUT (loc)	✓	*	✓	*	*	*	*	*	*	*	*	*	*	*	*	✓	✓
ADJACENT	✓	✓	*	*	*	*	*	*	*	*	*	*	*	✓	*	✓	✓
ADRIFT	*	*	✓	*	*	*	*	*	*	*	*	*	*	*	*	✓	*
AGO	✓	*	*	*	*	*	*	*	*	*	*	*	✓	*	*	✓	✓
AHEAD	*	✓	✓	*	*	*	*	*	*	*	*	*	✓	✓	*	✓	✓
ALBEIT	*	*	*	*	✓	✓	*	✓	*	✓	✓	*	*	*	*	*	✓
ALLOWING	*	*	*	*	*	*	✓	✓	*	*	*	*	*	*	*	✓	✓
ALTHOUGH	*	*	✓	*	*	✓	*	✓	*	✓	✓	*	*	*	*	*	✓
AMID	✓	*	*	*	*	*	*	*	*	*	*	*	*	✓	*	✓	✓
APART (“away”)	*	✓	✓	*	*	*	*	*	*	*	*	*	✓	✓	*	✓	*
APART (“except”)	✓	✓	*	*	*	*	*	*	*	*	*	*	*	*	*	*	✓
ASHORE	*	*	✓	*	*	*	*	*	*	*	*	*	*	✓	*	✓	✓
AWAY	*	✓	✓	*	*	*	*	*	*	*	*	*	✓	✓	✓	✓	✓
BAR	✓	*	*	*	*	*	*	*	*	*	*	*	*	*	*	*	✓
BEARING	*	*	*	*	*	*	*	*	*	*	✓	*	*	*	*	✓	✓
BECAUSE	*	✓	*	*	*	✓	*	✓	*	*	*	*	*	*	*	✓	✓
BEFORE	✓	*	✓	*	*	✓	*	*	*	✓	*	*	✓	✓	*	✓	✓
BEHIND	✓	*	✓	*	*	*	*	*	*	*	*	*	✓	✓	*	✓	✓
BETWEEN	✓	*	✓	*	*	*	*	*	*	*	*	*	✓	*	*	✓	✓
CONSIDERING	✓	*	*	*	✓	✓	*	✓	*	*	*	*	*	*	*	✓	✓
CONTRARY	*	✓	*	*	*	*	*	*	*	*	*	*	*	*	*	✓	✓
COUNTING	✓	*	*	*	*	*	*	*	*	*	*	*	*	*	*	✓	✓
EXCEPT	✓	✓	*	*	✓	✓	*	✓	*	*	✓	*	*	*	*	✓	✓
FOR FEAR	*	✓	*	*	✓	✓	*	✓	*	*	*	*	*	*	*	✓	✓
FROM	✓	*	*	*	*	*	*	*	*	✓	*	*	*	✓	*	✓	✓
GIVEN	✓	*	*	*	✓	✓	*	✓	*	*	*	*	*	*	*	*	✓
IF (interrogative)	*	*	*	*	*	✓	*	✓	*	*	*	✓	*	*	*	*	*
IN (non-locative)	✓	*	*	*	✓	*	*	✓	*	✓	*	*	*	*	*	✓	✓
IN CASE	*	✓	✓	*	*	✓	*	✓	*	*	*	*	*	*	*	✓	✓
INSTEAD	*	✓	✓	*	*	*	*	*	*	*	*	*	*	*	*	✓	✓
INTO	✓	*	*	*	*	*	*	*	*	✓	*	*	✓	✓	*	✓	✓
IN ORDER	*	*	*	*	✓	*	✓	✓	*	*	*	*	*	*	*	✓	✓
IN TWO MINDS	*	✓	✓	*	*	*	*	*	*	*	*	*	*	*	*	✓	*
LEST	*	*	*	*	*	✓	*	✓	*	*	*	*	*	*	*	*	✓
NEAR	✓	✓	✓	*	*	*	*	*	*	*	*	*	*	✓	*	✓	✓
NEXT	*	✓	✓	*	*	*	*	*	*	*	*	*	*	✓	*	✓	✓
NOTWITHSTANDING	✓	*	✓	*	✓	✓	*	✓	*	*	*	*	*	*	*	✓	✓
NOW	*	*	✓	*	✓	*	*	✓	*	*	*	*	*	✓	*	✓	✓
OF	✓	*	*	*	*	*	*	*	✓	✓	*	*	*	*	*	✓	*
ON (non-locative)	*	*	✓	*	*	*	*	*	*	*	*	*	✓	*	✓	✓	✓
OVER	✓	*	✓	*	*	*	*	*	*	*	*	*	✓	✓	✓	✓	✓
PER	✓	*	✓	*	*	*	*	*	*	*	*	*	*	*	*	✓	*
PROVIDED	*	*	*	*	✓	✓	*	✓	*	*	*	*	*	*	*	✓	✓
SINCE (temporal)	✓	*	✓	*	*	✓	*	*	*	✓	*	*	*	*	*	✓	✓
THAT (empty)	*	*	*	*	*	✓	*	✓	*	*	*	*	*	*	*	✓	*
TIMES	*	*	✓	✓	*	*	*	*	*	*	*	*	*	*	*	✓	✓

	A	B	C	D	E	F	F*	G	H	I	J	K	L	M	N	O	P
TOUCHING	✓	✓	*	*	*	*	*	*	*	*	*	*	*	*	*	✓	✓
UNLESS	*	*	*	*	*	✓	*	✓	*	✓	✓	*	*	*	*	✓	✓
UNTIL	✓	*	*	✓	*	✓	*	✓	*	✓	✓	*	*	✓	*	✓	✓
UP	✓	✓	✓	*	*	*	*	*	*	*	*	*	✓	✓	✓	✓	✓
UPON	✓	*	*	*	*	*	*	*	*	✓	*	*	*	*	*	✓	✓
VERSUS	✓	*	*	*	*	*	*	*	*	*	*	*	*	*	*	✓	*
WHEN	*	*	*	*	*	✓	*	✓	*	✓	✓	*	*	✓	*	✓	✓
WHENEVER	*	*	✓	*	*	✓	*	✓	*	✓	*	*	*	*	*	✓	✓
WHETHER	*	*	*	*	*	✓	*	✓	*	✓	✓	✓	*	*	*	✓	✓
WHILE (temporal)	*	*	*	*	*	✓	*	*	*	✓	✓	*	*	*	*	✓	✓
WITH	✓	*	*	*	*	*	*	*	✓	✓	*	*	*	*	*	✓	✓
WITHOUT	✓	*	*	*	*	✓	*	✓	✓	✓	*	*	*	*	*	✓	✓
X-STAIRS	*	*	✓	*	*	*	*	*	*	*	*	*	✓	✓	*	✓	✓

7.2. The organisation of the precomp classes

Taking all the syntactic facts presented above into consideration, the following fundamental questions in (a–c) emerge.

- how are these categories stored in the mind?
- what is the appropriate analysis of all these syntactic categories?
- and what generalisations can be captured from these facts?

To answer these questions, some general- and specific-domain models of categorisation need to be taken into account and incorporated into the analysis of the precomp classes. Because there is an avalanche of proposed models of categorisation, some of which are considerably sophisticated, it is necessary to restrict the selection of models. This is not the place to offer a comprehensive discussion on these models, so I will restrict myself to some basic remarks. These will offer some theoretical tools which allow a linguist to chain together individually established categories into hierarchies. The mechanisms which will be implemented in the current study are embraced in the models sketched in turn below.

7.2.1. Inheritance hierarchy model

All versions of CxG employ general-domain taxonomic relations in the organisation of constructions (Croft & Cruse, 2004). The inheritance hierarchy is a logical property of taxonomic networks and a mechanism required to analyse the syntactic data presented above. It is a standard practice in linguistics to diagram taxonomic relations in trees with superclasses at the top, which means subclasses are diagrammed below their superclasses. The convention for diagramming these trees and their inheritance structure turns out to be just as in non-linguistic categories.

As will become clear in the ensuing discussion, the notion of hierarchy and the mechanisms for inheritance of properties (Fillmore, 1985; Fillmore et al., 1988; Goldberg, 1995) will be replicated here in the diagramming of the precomp categories and captured by the tree branching to connect subcategories with their supercategories and also capture generalisations about them. All the diagrams demonstrating the analyses of the precomp classes which will be presented later show a kind of hierarchical network.

Since we are not dealing with a simple stacking up of unrelated categories, the classes will be chained together in light of their properties; I have represented this chaining using the ‘↓’ sign. It demonstrates that the category structure is simply formed from chains of sub-categories and superordinate categories. This will yield hierarchical trees which will be

demonstrated later in this chapter. The trees are composed of nodes and each node represents a syntactic category which from a structuralist point of view is defined as descriptions of syntactic properties (McCawley, 1982). In practice, there is no qualitative difference between the classes and the syntactic features they have. The upper side of the nodes contains the labels of the syntactic categories and in the lower side are their syntactic features listed in the alphabetical order as shown above.

At each branch point lies the most superclass category of all the categories descended from that branch point. For example, in Figure 1 the branch point giving rise to the GIVEN class, ALBEIT class and FOR FEAR class, we find the most common ancestor of these two categories, namely the PROVIDED class. At the branch point right above the root of the tree, we find the most common ancestor of all the categories in the tree, which is the LEST class.

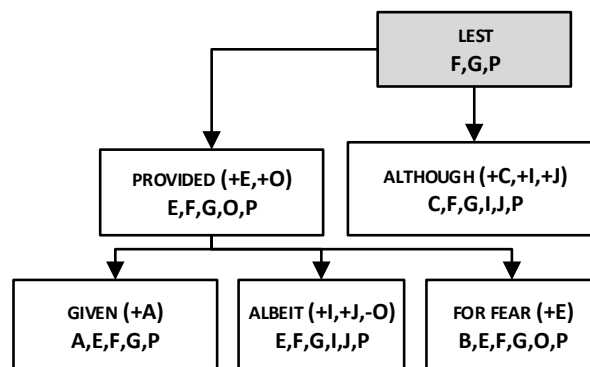

Figure 1. Principles of creating a hierarchical tree

Each arrow in the tree branching either from the bottom or the side of the box represents a series of categories, leading to the finalist subcategories of that series at its end. For example, the arrows leading down to the FOR FEAR category represents the category ancestors since it diverged from the other categories in the tree. Similarly, the root represents a series of categories leading down to the last subcategories of all the categories in the tree. There might be more than one possible analysis for drawing up the inheritance hierarchy. For instance, the example in Figure 1 requires two rules/changes to derive ALBEIT from ALTHOUGH, namely $-C +E$. ALBEIT could also be derived from PROVIDED with three rules. However, the simplest analysis is what is adopted here.

The tree in Figure 1 has nice and clean branching patterns, with either two or three lineages (i.e., lines of descent) emerging from each branch point. However, there are some diagrams drawn with a branch point that has three or more different categories.

7.2.2. All-Or-None Model

The oldest ideas on categorisation were those of Aristotle. A particular entity is defined by a set of ‘necessary and sufficient conditions’ (Van der Auwera & Gast, 2011: 170–1). This ‘classical’ or ‘traditional’ way of categorisation is known as the ‘Aristotelian’ model of categorisation (Aarts, 2007; Divjak & Arppe, 2013; Taylor, 2003). In speaking of non-linguistic classes, a bachelor is a category whose members are human, male, unmarried and eligible (Kruschke, 2008: 267). For linguistic categories, it is necessary for a given syntactic item to meet all the criterial conditions set to identify that syntactic category, otherwise it will be excluded (Kruschke, 2008; Tuggy, 2007). In Van der Auwera and Gast’s (2011: 171) words, “[c]ategory membership can thus be determined by checking the relevant attributes, and for each item, this will lead to either inclusion or exclusion from the category in question”. Syntactic elements can

be classified as adjectives, for instance, only if they can be used in attributive and predicative positions, they do not inflect for aspect and they may not project (non-elliptical) noun phrases (Van der Auwera & Gast, 2011: 171).

For the purpose of the current research, consider the UPSTAIRS category, for example. The members of this class have the following five properties (a) they are constantly without complement (cf. (17i)); (b) they can be modified by a measure phrase (cf. (17ii)); (c) they can be modified by *right* or *straight* (cf. (17iii)); (d) they can be used in a predicative complement function (cf. (17iv)); and (e) they can head non-predicative modifier phrases (cf. (17v)). If all these properties serve to define the UPSTAIRS class, it is necessary that any syntactic item belonging to this class has to meet all these five conditions.

17. i. She strolled *upstairs* [___]. [BNC: A0L 3556]
- ii. He walked *515 feet upstairs*. [BNC: DK3 345]
- iii. It was *right upstairs* above the shop and all the women were nice. [BNC: CK9 276]
- iv. They're *upstairs*. [BNC: BMS 3588]
- v. *She strolled upstairs*. [BNC: A0L 3556]

A given class may belong to many classes in order to obtain all of its properties. This is illustrated in Figure 2, where the BECAUSE class belongs to both the LEST class and the THAT (empty) class.

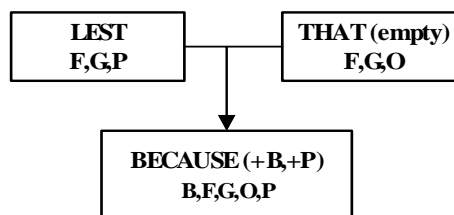

Figure 2. Multiple class membership

There is no stipulation of multiple class membership, but rather it follows simply from the definition of classes. One class is a subgroup of another if the set of properties that the subclass has is a superset of the properties the superclass has.

7.2.3. Prototype Model

This model contrasts with the preceding model in which not all the properties of a given superclass need be inherited by their subclasses. This section discusses this contrasting strategy; it corresponds to the prototype model (Rosch 1973) On the prototype view, the overriding parameter dominates. How this overriding works can be simplified by looking at the classification of non-linguistic categories, such as the category BIRD which has different types of properties, like (i) it has the ability to fly, (ii) it has feathers, (iii) it has an S-shape, (iv) it has wings, (v) it lays eggs, and (vi) it has a beak (Geeraerts, 1989: 599). Blackbirds and sparrows are widely assumed to be prototypical examples of birds, but not penguins and kiwis by virtue of the fact that the latter lack the 'flying' property (*ibid.*). This notion is what is commonly known as 'inheritance overriding' (Bento et al., 1997: 1019). It is an exception handling mechanism that helps not reaching the wrong conclusion that bird-like objects are not birds due to the local absence of the flying property. If systems of categorisation allow it, it is understandable to assume that the classifying scheme of prepcomps is organised in a similar way. The tree in Figure 3 the PROVIDED class with the properties E,F,G,O,P is a subtype of the

category considering with the properties A,E,F,G,O,P, but with one of the properties A,E,F,G,O,P being the lack of A, and GIVEN is a subtype of considering with the lack of O.

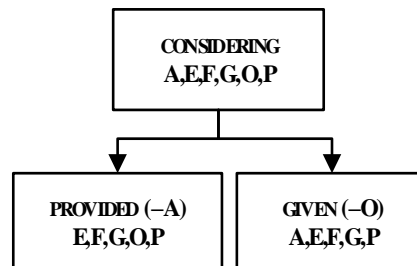

Figure 3. Classification with inheritance overriding

7.2.4. Schematicity Model

The classification system in accordance with this model is organised around the concept of schemata. The technique implemented is akin to varying abstraction modelling that assumes abstract processes underlie category representations (Divjak & Arppe, 2013; Langacker, 1987, 2005; Murphy, 2002; Tuggy, 2007).

Let's start with a definition of the notion of schematicity. A schema is defined as a "superordinate concept, which specifies the basic outline common to several, or many, more specific concepts", which are known as 'elaborations', 'instantiations' or 'subcases' of the schema (Tuggy, 2007: 83). That is, "any concept that abstracts away from differences among similar subcases may be properly called schema" (Tuggy, 2007: 84). "The highest-level schema [...] embodies the maximal generalisation that can be extracted as a characterisation of the category membership" (Langacker, 1987: 371). Schematicity also inevitably co-exists with the inheritance hierarchy; they are not mutually exclusive. To show how these two concepts relate to one another, take the two systems of classification of non-linguistic categories in (18–19) below as examples.

18. THING → ANIMAL → MAMMAL → RODENT → SQUIRREL → GROUND SQUIRREL
 19. MOVE → LOCOMOTE → RUN → SPRINT

(Langacker, 1987: 132)

Schematic relationships are instantiated by arrows, where schemas are at the tail and their elaborations at the head of the arrow. The arrow is used to instantiate the relationships between schematic categories and their elaborations. At each level, more than one elaboration is possible. For instance, CONTRACT, WAVE or FALL can replace LOCOMOTE; WALK, CRAWL or (purposely) ROLL are possible alternations of RUN, and JOG or TROT can substitute for SPRINT. Since schematicity is a 'transitive' concept, $A \rightarrow B$ and $B \rightarrow C$ require $A \rightarrow C$ (Tuggy, 2007: 84).

This cognitive mechanism imposes the constraint that not every class must have members. In so doing, more categories will be required in the precomp classification system, but fewer rules will be needed to define the classes. To show the taxonomic relation among classes with the notion of schematicity incorporated, take the verbs *tickle*, *die*, *break* and *weigh* as examples. First, *tickle* occurs in the TRANSITIVE constructions, and *die* occurs in the INTRANSITIVE constructions. *Beak* can be either a transitive or an intransitive verb and *weigh*, on the other hand, occurs in the INTRANSITIVE constructions but not in the PASSIVE construction. The reason behind assigning all these items to the category VERB despite their different syntactic behaviour is that they all occur in the MORPHOLOGICAL VERB construction (i.e., the Present \emptyset /*s* alternation and the Past *-ed* morpheme) (Croft, 2013: 219). This is diagrammatically illustrated

in Figure 4 where all the verbs belong to the schematic category MorphV. It has been adapted from Croft (2013: 22).

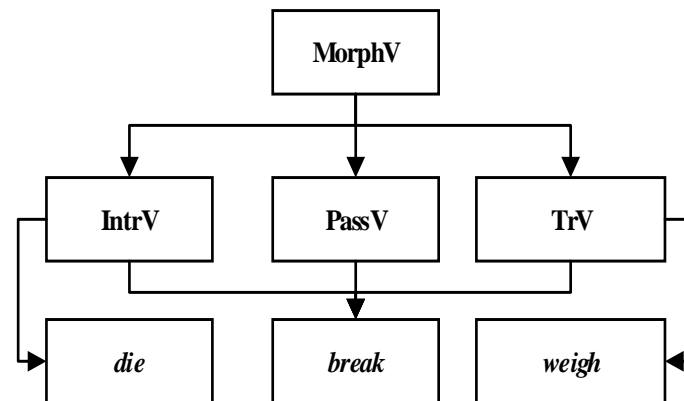

Figure 4. Taxonomic representation in verbal constructions

Not permitting schematic categories tends to miss the generalisation that some classes have properties in common with other classes. It also tends to result in a good deal of redundancy found amongst members of word classes. This is because much of the information in fully specified entries is also shared by other syntactic items which do not belong to the same class. The categorisation of the classes in Figure 5 is a case in point. With the schematic category inserted, only four rules, which are represented with numbers in the diagram, are needed in contrast with the analysis without schematicity in Figure 6, which requires six rules⁷. That is, the C,L,M,N,O,P category is a subtype of the X-STAIRS category with the addition of Property N. Then, the non-locative on is a subtype of C,L,M,N,O,P with the lack of Property M. Over and away are also subtypes of the same category but with the inheritance of Property A and Property B respectively.

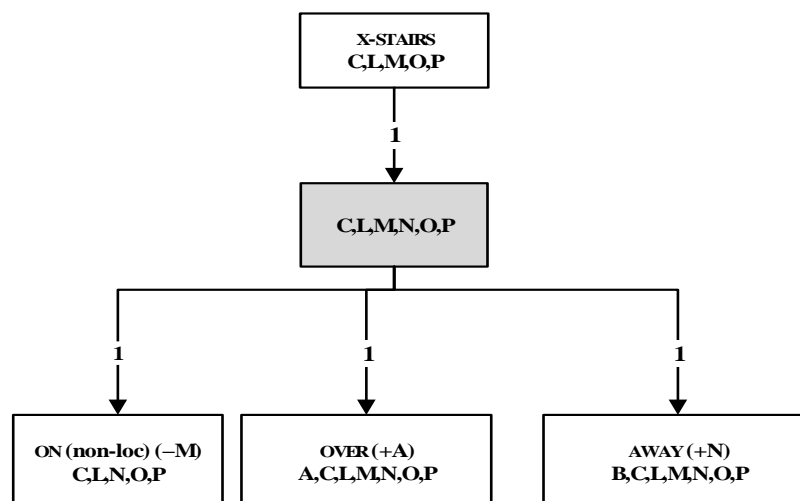

Figure 5. Taxonomic representation with schematicity

⁷ My gratitude goes to Dr. And Rosta, who suggested this method of measuring the simplicity of the diagrams.

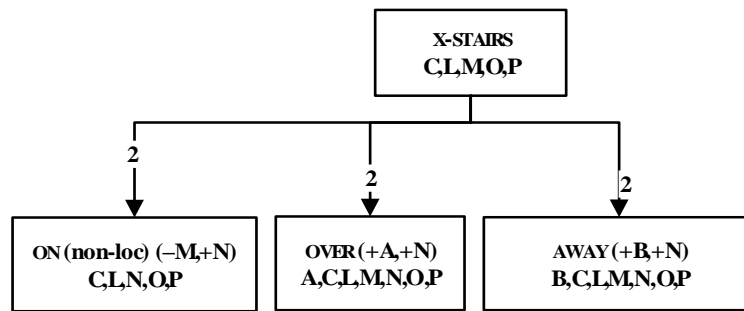

Figure 6. Taxonomic representation without schematicity

The two possible analyses with and without the implementation of the two mechanisms discussed earlier, namely overriding (O) and schematicity (S) are demonstrated in Figure 7 and Figure 8.

Analysis A (-S, -O)

In this kind of analysis, the principles of overriding and schematic categories are prohibited. Figure 7 demonstrates the analysis of the prepcomp categories in the absence of these principles. The features of this analysis are: (a) there are 10 superclasses and the remaining categories branch from (i.e., are subclasses of) these superclasses, and (b) every class must have lexical members and all the syntactic properties of the superclasses need to be incorporated by the subclasses. Note that additional inherited properties are marked in the diagram by the + sign between two brackets.

Analysis B (+S, +O)

The type of analysis proposed here incorporate both the concepts of schematicity and overriding. Both have been considered to see whether there is any simplification that could be made to describe the overall classification system of precomps. This is captured by the diagram in Figure 8. Note that schematic categories are the categories without members and lack of properties, which captures the overriding principle, have been noted using the – sign between two brackets.

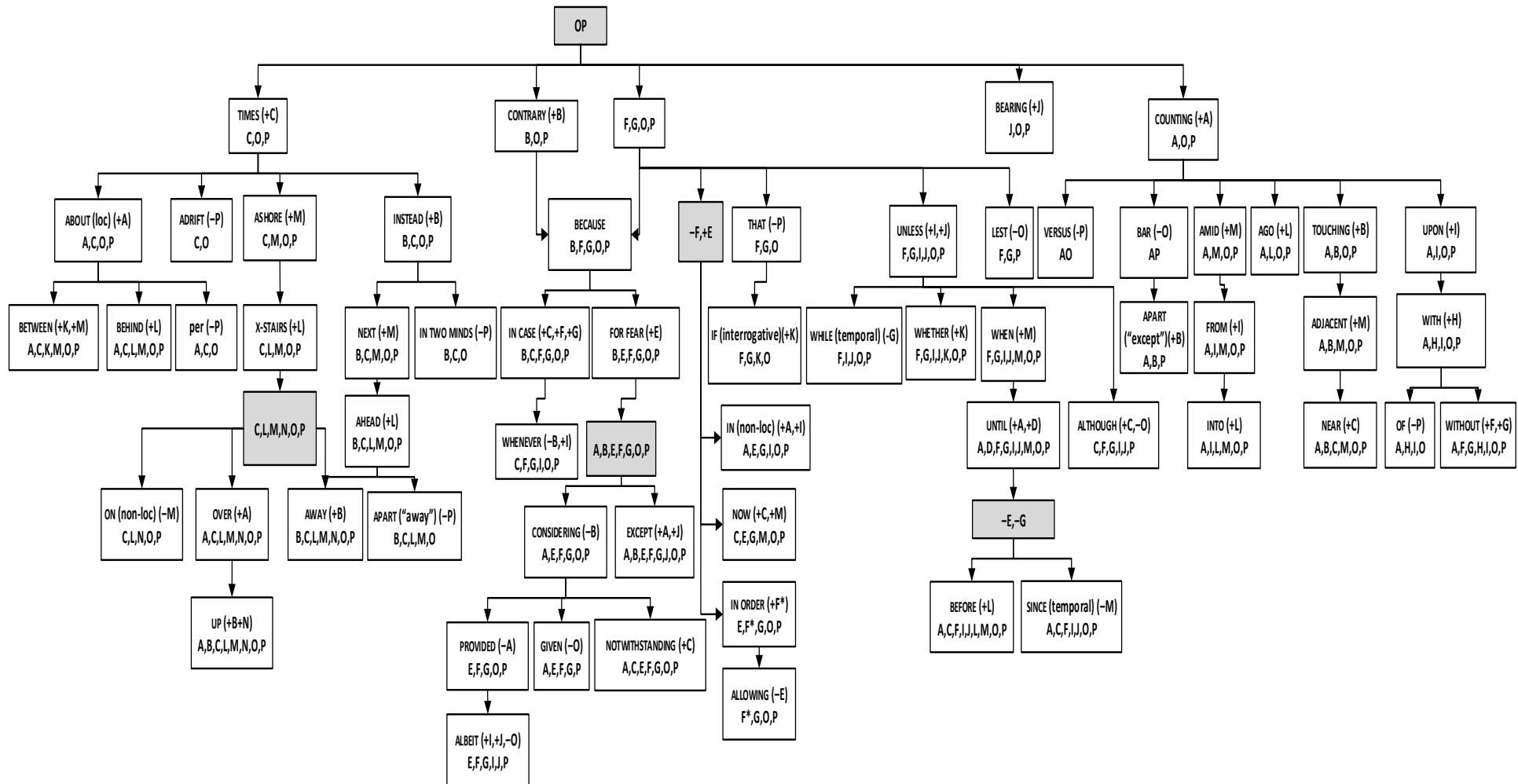

Figure 8. Classification of prepcs with (+S, +O)

7.2.5. Qualitative evaluation

The diagrams of the analyses presented above are insightful in many respects. First, the syntactic distribution of the words claimed to belong to the categories of prepositions and complementisers is intricate. The traditional two-category classification, therefore, is too plain. It disguises a considerable amount of interesting syntactic facts about these items. But despite the tremendous number of categories proposed in place of the two existing categories, still they are not represented as a random collection of categories. They are shown as related as super- and sub-classes in the light of the inheritance hierarchy.

Additionally, the criteria used to posit these categories are clear-cut. In the two analyses considered above, there are clearly discrete categories with clear-cut boundaries. Gradience was not considered since allowing for gradience "... potentially opens the floodgates to a mass of uninterpretable and unclassifiable phenomena ..." (Aarts, 2007: 12).

The categorisation of lexical items and the establishment of the basic classes of the precomps is only as reliable as the individual judgements and the BNC and COCA findings behind the \pm values. But nevertheless if a few judgements and findings are erroneous, the overall character of the analysis – the overall nature of the problem and the analytical section – still holds.

For that matter, there are some other syntactic features which I have not taken into an account. In addition to this, there are also various exclusions from the current investigation in terms of the syntactic items investigated. Thus, it is not the final word on such a matter, but it remains indicative of the general character of the problem raised and the solution proposed.

7.2.6. Mathematical count of the diagrams

A measurement is made by assuming by default that the topmost node has no inherited properties. To work out the way of deciding the simplest tree within the approaches under consideration, the same measuring scheme explained in §7.2.4 has been adopted. Each statement explaining what category a subtype of is counted as 1. Table 3 provides an overview of the numerical scores of the diagrams above.

Table 3. Numerical scores of the diagrams with ($\pm S$, $\pm O$)

Taxonomic representation	Raw numerical score
No schematic categories and no overriding ($-S$, $-O$)	71
Schematic categories and overriding ($+S$, $+O$)	65

As expected, the diagram with the lower score, thus the simpler as we need to describe the classifying system in as few statements as possible, is the one with schematic categories and overriding. Table 3 is also revealing in showing the relative cost of not allowing schematic categories and overriding. But if there are independent cognitive reasons for disallowing schematic categories and overriding, then it adds 5% of complexity to the diagram.

The current classification of the precomps leads to the question whether the distinction between lexical items and word classes is rather arbitrary. That is, many word classes contain only a small handful of lexical items and that is only with the criteria considered in this study; incorporation of more syntactic criteria, for instance, the positioning of adverbial modifiers, will of course lead to more fragmentation. That is, the more criteria we include, the more categories, or maybe more one-member categories, we will posit. There should be no restrictions on the number of members belonging to a given category as far as they capture syntactic differences and patterns. This is also voiced by Jacobsson (1977: 62) and Culicover

(1999: 79-82) who claim that *instead, once* and *notwithstanding*, for example, are *sui generis* syntactic categories. In the current classification of the prepcomp categories, *whether*, for instance, has been posited as a category in its own right as its syntactic behaviour does not seem to fully coincide with any other item.

7.3. Implications of the classification of the precomps

7.3.1. Problems of distributional classes

Categories are arrived at and defined by their occurrence or nonoccurrence of their members in different types of constructions are problematic. First, there is a mismatch in the distribution patterns within the identifying criteria (constructions) used to define a particular category. The mismatch in the distribution of English Direct Objects and Obliques is a case in point. The main criterion used to distinguish them is that only the former can occur as the subject of the verb in the passive voice. This is illustrated in (20–21).

20. a. Jack kissed *Janet*.
b. *Janet* was kissed by Jack.
21. a. The old man walked *with a cane*.
b. **A cane* was walked with by the old man.

(Croft, 2001: 35)

This does not seem to be always the case, however. There are some NP objects of verbs that cannot occur as Passive Subjects whilst there are some Oblique Objects that can occur as Passive Subjects. This is shown respectively in the examples in (22–23).

22. a. Jack weighs *160 pounds*.
b. **160 pounds* is weighed by Jack.
23. a. Claude Debussy *lived in this house*.
b. *Claude Debussy *lived this house*.
c. *This house* was lived in by Claude Debussy.

(Croft, 2001: 35)

This mismatch leads to more incorporation of diagnostic criteria (i.e. constructions) one uses to define categories. This would result in a very large number of syntactic categories, each of which would have very few members. This problem has been empirically proved in a very large grammar books of French developed by Gross and colleagues containing 600 rules and 12,000 syntactic items and the study concluded that there were no two syntactic items had identical syntactic distribution (Gross, 1979: 859–60 cited in Croft, 2001: 36). This is very highly likely to be equally applied to this study; only 19 criteria and only 186 precomps seen important have been examined in this study, but the more constructions and syntactic items belonging to the so-called categories of prepositions and complementisers included, the larger the number of categories that would be observed.

This issue can be observed in the current classification of the precomps. This calls into question the conclusion that PROVIDED and GIVEN diagrammatically shown in Figure 3 and reproduced in Figure 9, are subclasses of CONSIDERING and not as distinct classes.

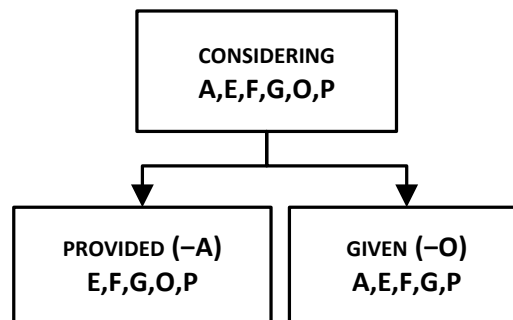

Figure 9. Forming distributional subclasses

A further issue is related to the allowance for multiple class membership (Croft, 2001: 38). For instance, nouns are distinguished from adjectives by the fact that the latter can occur with the anaphoric *one*, as shown in (24), whilst the former can occur as the head of noun phrases, as in (25). However, words such as *rich* and *poor* can meet the two criteria. Thus, they are usually claimed to belong to both the categories Noun and Adjective.

24. a. *the *book one*/*the *student one*/ etc.
b. the *short one*/the *deep one*/ etc.
c. the *rich one*/the *poor one*/ etc.
25. a. the *book*/the *student*/ etc.
b. *the *short*/*the *deep*/ etc.
c. the *rich*/the *poor*/ etc.

A similar problem can also be pointed out when multiple class membership is permitted in the current classification of the precomps. In Figure 10, the NEXT class has been claimed as a class sharing all its properties of the IN TWO MINDS class and ASHORE class, thus belonging to the two classes. The same question arises here: why should this be accounted for by multiple class membership and not a third class?

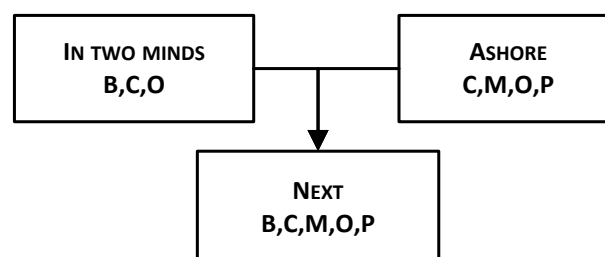

Figure 10. Problems in allowing multiple class membership

7.3.2. Precomps aren't primitive units of syntactic representation

The problems levelled at the distributional analysis can be summarised as follows. First, distributional criteria do not seem to match at least within languages. Second, there does not look like there is justification for determining the right distributional criteria for establishing syntactic categories. In a nutshell, the distributional tests cannot be reliable, and these observable issues call into question the existence of high-level syntactic generalisations such as Noun Phrase, Subject and Object, or even part-of-speech categories such as Noun and Verb (Croft, 2001: 45; Hilpert, 2014: 68). If the validity of the distributional analysis used to establish syntactic categories which are considered atomic grammatical primitives in contemporary

syntactic theories is questionable, at issue then is: what is the alternative approach to syntactic categories?

The best hope lies in a theory of grammar that accounts for these mismatches of syntactic distributions. The view that all categories are language-specific (Dryer, 1997 cited in Croft, 2001: 50) and there are no atomic grammatical primitives lends itself to an account in the spirit of Construction Grammar where it is argued that “CONSTRUCTIONS, NOT CATEGORIES OR RELATIONS ARE THE BASIC, PRIMITIVE UNITS OF SYNTACTIC REPRESENTATION. The categories and relations found in constructions are derivative ...” (Croft, 2001: 46). Croft (2001: 55) adds that “no schematic syntactic category is ever an independent unit of grammatical representation” and high-level syntactic generalisations can only be part of knowledge of language when speakers figure out similarities across constructions and form a generalisation. Along these lines, Hilpert (2014: 68–71) states “nothing crucial depends on them. The crucial work is done by constructions that occupy lower levels of abstraction in the construct-i-con ... [and they] are desirable from theoretical point of view, as they allow the construction of elegant models of linguistic knowledge.”

Making the same assumptions in the case of categories proposed in the current study means that the NP complement construction, *Right/Straight* modification construction, predicative complement in Raising constructions and non-predicative modification construction are taken to be identifying for the AMID category and the conclusions are indicative of these constructions rather than some universal category known as the AMID class. Speakers would make a generalisation across more concrete constructional schemas. Since many different prepcomps seem to occur in such constructions, speakers may perceive this similarity and arrive at a higher-level generalisation, which would correspond to more schematic categories.

8. Conclusion

8.1. Overall summary of the findings

This paper was an investigation of what are commonly known as prepositions and/or complementisers. Due to the inadequacy of the syntactic criteria proposed in previous research, it has argued against a binary preposition–complementiser classification of all the syntactic items claimed to belong to these categories. All the attempts made to identify the two categories in question as distinctive classes are flawed. The idea that the existence of the two categories under discussion is challenged should come as no surprise since this has been previously shown from the literature. The distinction made between them seems to be taken for granted and the syntactic criteria set to identify them appear to account for superclasses or subclasses of the so-called prepositions and complementisers but not the whole set. Therefore, the behaviour of most of the many items classified as prepositions and/or complementisers in some major grammars of English was tested with regard to a range of syntactic factors. On the basis of this, at least 59 distinct classes were formed. And, finally, possible taxonomies of these 59 categories were also structured in the framework of Construction Grammar. That is, the study has also shown that these classes are not represented as a random collection of categories, but rather they are related as super- and sub-classes in the light of the inheritance hierarchy. Two possible taxonomies of these 59 categories were structured. However, the establishment of the basic classes of the prepcomps is only as reliable as the individual judgements and the BNC and COCA findings. But nevertheless if a few judgements and findings are erroneous, the overall character of the analysis – the overall nature of the problem and the analytical section – still holds.

To overcome the drawbacks of the distributional classes proposed in this study, a constructional framework was adopted where was argued that all categories are language-specific and there are no atomic grammatical primitives. That is, constructions and not

categories are the basic, primitive units of syntactic representation. No schematic syntactic category is ever an independent unit of grammatical representation and high-level syntactic generalisations can only be part of knowledge of language when speakers figure out similarities across constructions and form a generalisation.

8.2. Implications

Four main implications can be drawn from the current investigation. First, the categorisation of the lexical items and the establishment of the basic classes of the prepcomps shows the failure of current dictionaries with respect to their categorisation of prepositions and complementisers and probably other categories (Pullum, 2009: 263). The 59 lexical entries proposed here need to replace the existing lexical entries in dictionaries. The most appropriate procedure would be to list all the 59 classes as separate entries. Second, the possible structure of the taxonomy of the new classes shows how complicated the classification system of the prepcomps is and their classification definitely needs to go beyond the existing binary classification system. Furthermore, despite the fact that the categories created here are not universal as they were formed using ‘parochial criteria’ (Rosta, personal communication) (i.e. syntactic frames local to a specific language), a linguist investigating other languages might find it useful to know what classification system might be useful to capture generalisations about given classes.

The current study has also shown that the widely known non-predicative adjunct property proposed by Pullum and Huddleston (2002) to draw a sharp boundary between English prepositions and other syntactic categories including complementisers is problematic. The lexical items commonly known as complementisers (‘subordinators’ in Huddleston’s (2002: 1011) terms), such as *whether* and *that* and nouns also appear to have the ability to occur in subject or complement positions, or more precisely, as heads of non-predicative adjuncts. In this way, the two categories in question cannot be distinguished on the basis of this criterion.

8.3. Limitations & Future work

This section alludes to a discussion of the limitations of the current study, which, I believe, will be research areas ripe for further exploration. An obvious limitation is that not all of the relevant criteria were tested due to time constraints. In essence, this is a common drawback of the distributional analysis method (Valeika & Buitkiene, 2003).

There are some conflated properties that need to be refined in future work. First, the ‘prepositional complement’ property needs to be deconflated into multiple properties based on the new classification system of the prepcomps proposed here. In other words, the prepcomps which select *of*, *with* and *from*, for instance, need to be categorised as selecting the three distinct prepcomps respectively.

Another property which will be intriguing to separate in a more refined analysis is the property of “the small clause complements with raised subject and non-verbal predicate”. It is a conflation of two distinct properties. There is a need to specify to where the subject is raised. Compare the two examples of *if* in (26).

26. a. *If possible*, I’ll call you tomorrow.
c. *If hungry*, I’ll eat my lunch.

In (129a), what is possible is what *if* modifies (i.e. the subject of the small clause complement is *I’ll call you tomorrow*) whereas in (26b) the subject of the small clause complement is also the subject of what *if* modifies. From this, it can be noted that the prepcomp that has a small

clause complement behaves differently. There are some precomps which can have both, as in the case of *whenever*, and some which can have only one, as in the case of *although*.

Acknowledgement

My sincere gratitude goes to my PhD supervisor, Dr. And Rosta and Dr. George Walkden for extensively reviewing the whole paper and providing invaluable feedback for improvement.

References

- [1] Aarts, Bas. 2007. *Syntactic Gradience: The nature of grammatical indeterminacy*. Oxford: Oxford University Press.
- [2] Aarts, Bas. 2011. *Oxford Modern English Grammar*. Oxford: Oxford University Press.
- [3] Almahammed, Yazan. S. 2015. The acquisition of preposition stranding and pied piping in interrogatives by Arabic Jordanian EFL. *International Journal of Linguistics* 7: 16–26.
- [4] Aristotle. 2004. Categories. In B. Aarts, D. Denison, E. Keizer and G. Popova (eds.). *Fuzzy Grammar: A reader*. Oxford: Oxford University Press.
- [5] Ballard, Kim. 2007. *The Frameworks of English: Introducing language structures*. (Second edition). New York: Palgrave Macmillan.
- [6] Barðdal, JÓHANNA. and Eythórsson, T THÓRHALLUR. 2012. Reconstructing syntax: construction grammar and the comparative method. In H. C. Boas and I. A. Sag (eds.). *Sign-based construction grammar*, 257–308. Stanford: CSLI publications.
- [7] Barðdal, Jóhanna., Kristoffersen, Kristian. E. and Sveen, Andreas. 2011. West Scandinavian ditransitives as a family of constructions: with a special attention to the Norwegian “V-REFL-NP’Construction”. *Linguistics* 49: 53–104.
- [8] Bento J., Feijó B., Smith D. L. 1997. Engineering design knowledge representation based on logic and objects. *Computers & Structures* 63: 1015–1032.
- [9] Bergs, Alexander. 2010. Expressions of futurity in contemporary English: A Construction Grammar perspective. *English Language & Linguistics* 14: 217–238.
- [10] Birner, Betty. J. and Ward, Gregory. 1998. *Information Status and Noncanonical Word Order in English*. Amsterdam: John Benjamins Publishing.
- [11] Boas, Hans. C. 2011. Coercion and leaking argument structures in Construction Grammar. *Linguistics* 49: 1271–1303.
- [12] Carnie, Andrew. 2011. *Modern Syntax: A coursebook*. Cambridge: Cambridge University Press.
- [13] Chafe, W. 1992. The importance of corpus linguistics to understanding the nature of language. In J. Svartvik (ed.). *Directions in Corpus Linguistics*, 79–97. Berlin: Mouton de Gruyter.
- [14] Chen, Marina. Y. 2005. English prototyped small clauses in the interlanguage of Chinese/Taiwanese adult learners. *Second Language Research* 21: 1–33.
- [15] Chung, Sandra. and McCloskey, James. 1987. Government, Barriers, and Small Clauses in Modern Irish. *Linguistic Inquiry* 18: 173–237.
- [16] Citko, Barbara. 2008. Small clauses reconsidered: not so small and not all alike. *Lingua* 118: 261–295.
- [17] Croft, William. 2001. *Radical Construction Grammar: Syntactic theory in typological perspective*. Oxford: Oxford University Press.
- [18] Croft, William. 2013. Radical Construction Grammar. In T. Hoffmann and G. Trousdale (eds.). *The Oxford Handbook of Construction Grammar*, 211–232. Oxford: Oxford University Press.

- [19] Croft, William. and Cruse, Alan. D. 2004. *Cognitive Linguistics*. Cambridge: Cambridge University Press.
- [20] Culicover, Peter. W. 1999. *Syntactic Nuts: Hard cases, syntactic theory, and language acquisition*. Oxford: Oxford University Press.
- [21] Davidse, Kristin. 2000. A constructional approach to clefts. *Linguistics* 38: 1101–1132.
- [22] Davies, Mark. 2010. The Corpus of Contemporary American English as the first reliable monitor corpus of English. *Literary and Linguistic Computing* 25: 447–464.
- [23] Denison, David. 1998. Syntax. In Romaine, S. (ed.) *The Cambridge History of the English Language vol. 4 1776-1997*, 92–329. Cambridge: Cambridge University Press.
- [24] De Smet, Hendrik. 2009. Analysing reanalysis. *Lingua* 119: 1728–1755.
- [25] Divjak, D. and Arppe, A. 2013. Extracting prototypes from exemplars What can corpus data tell us about concept representation? *Cognitive Linguistics* 24: 221–274.
- [26] Dryer, Matthew. 1997. Are grammatical relations universal? In J. Bybee, J. Haiman, S. A. Thompson (eds.). *Essays on language function and language type*, 330–333. Amsterdam: Benjamins.
- [27] Dubinsky, Stanley. and Williams, Kemp. 1995. Recategorisation of prepositions as complementizers: The case of temporal prepositions in English. *Linguistic inquiry* 26: 125–137.
- [28] Fabb, Nigel. 1994. *Sentence Structure*. London: Routledge.
- [29] Falk, Yehuda. N. 1984. The English auxiliary system: A lexical-functional analysis. *Language* 60: 483–509.
- [30] Fiengo, Robert. 1980. *Surface Structure: The interface of autonomous components*. Cambridge: Harvard University Press.
- [31] Fillmore, Charles. J. 1985. Syntactic intrusions and the notion of grammatical construction. *Proceedings of the Berkeley Linguistics Society* 11: 73–86.
- [32] Fillmore, Charles. J., Kay, Paul., and O'connor, Mary. C. 1988. Regularity and idiomaticity in grammatical constructions: The case of *let alone*. *Language* 64: 501–538.
- [33] Flickinger, Daniel. P. 1987. *Lexical Rules in the Hierarchical Lexicon*. Ph.D. Stanford University.
- [34] Francis, E. 1999. *Variation within Lexical Categories*. Ph.D. University of Chicago Press.
- [35] Fried, Mirjam., and Östman, Jan-Ola. 2004. Construction grammar: a thumbnail sketch. In M. Fried and J. Östman (eds.) *Construction Grammar in a Cross-language Perspective*, 11–86. Philadelphia: John Benjamins Publishing Company.
- [36] Geeraerts, Dirk. 1989. Introduction: Prospects and problems of prototype theory. *Linguistics: An Interdisciplinary Journal of the Language Sciences* 27: 587–612.
- [37] Goldberg, Adele. E. 1995. *Constructions: A construction grammar approach to argument structure*. Chicago: University of Chicago Press.
- [38] Goldberg, Adele. E. 2003. Constructions: A new theoretical approach to language. *Trends in Cognitive Sciences* 7: 219–224.
- [39] Goldberg, Adele. E. 2006. *Constructions at Work: The nature of generalization in language*. Oxford: Oxford University Press.
- [40] Goldberg, Adele. E. 2013. Constructionist approaches. In T. Hoffmann and G. Trousdale (eds.). *The Handbook of Construction Grammar*, 19–31. Oxford: Oxford University Press.

- [41] Haegeman, Liliane. 1994. Verb raising as verb projection raising-some empirical problems. *Linguistic Inquiry* 25: 509–522.
- [42] Haegeman, Liliane. and Guéron, Jacqueline. 1999. *English Grammar: A generative perspective*. Oxford: Blackwell.
- [43] Harris, Zellig. S. 1951. *Methods in Structural Linguistics*. Chicago: The University of Chicago Press.
- [44] Hilpert, Martin. 2014. *Construction Grammar and its Application to English*. Edinburgh: Edinburgh University Press.
- [45] Hirao, Hirao. 2014. Up above as a complex preposition. *English Linguistics Research* 3: 12–17.
- [46] Hirao, Hirao. 2015. Down below as a Complex Preposition. *English Linguistics Research* 5: 1–6.
- [47] Huddleston, Rodney. 1984. *Introduction to the Grammar of English*. Cambridge: Cambridge University Press.
- [48] Huddleston, Rodney. 1988. *English Grammar: An outline*. Cambridge: Cambridge University Press.
- [49] Huddleston, Rodney. 2002. Syntactic overview. In R. Huddleston and G. K. Pullum (eds.). *The Cambridge Grammar of the English Language*, 44–68. Cambridge: Cambridge University Press.
- [50] Huddleston, Rodney. 2002. Non-finite and verbless clauses. In R. Huddleston and G. K. Pullum (eds.). *Cambridge Grammar of the English Language*, 1171–1268. Cambridge: Cambridge University Press
- [51] Huddleston, Rodney. and Pullum, Geoffrey. K. 2005. *A Student's Introduction to English Grammar*. Cambridge: Cambridge University Press.
- [52] Huddleston, Rodney. and Pullum, Geoffrey. K. 2006. Coordination and subordination. In B. Aarts and A. McMahon (eds.). *The Handbook of English Linguistics*, 198–219. Oxford: Blackwell.
- [53] Hudson, Richard. 1995. Competence without Comp? In B. Aarts and C. F. Meyer (eds.). *The Verb in Contemporary English: Theory and description*, 40–53. Cambridge: Cambridge University Press.
- [54] Hudson, Richard. 2000. Grammar without functional categories. In R. Borsley, (ed.) *The Nature and Function of Syntactic Categories*, 7–36. New York: Academic Press.
- [55] Jackendoff, Ray. 1997. 'Twistin' the night away. *Language* 73: 534–559.
- [56] Jacobsson, Bengt. 1977. Adverbs, prepositions, and conjunctions in English: A study in gradience. *Studia Linguistica* 31: 38–64.
- [57] Kay, Paul. and Fillmore, Charles. J. 1999. Grammatical constructions and linguistic generalizations: The What's X doing Y? construction. *Language* 75: 1–33.
- [58] Kilgarriff, Adam. 2007. Googleology is bad science. *Computational linguistics* 33: 147–151.
- [59] McCawley, James. D. 1982. *Thirty Million Theories of Grammar*. Chicago: Chicago University Press.
- [60] Meyer, Charles. and Nelson, Gerald. 2006. Data collection. In B. Aarts and A. McMahon (eds.). *The Handbook of English Linguistics*, 93–113. Oxford: Blackwell Publishing.
- [61] Michaelis, Laura. A. 2004. Type Shifting in Construction Grammar: An integrated approach to aspectual coercion. *Cognitive linguistics* 15: 1–68.

- [62] Michaelis, Laura. A. 2012. Making the case for Construction Grammar. In H. C. Boas and I. F. Sag (eds.). *Sign-based Construction Grammar*, 31–68. Stanford: CSLI Publications:
- [63] Michaelis, Laura. A. and Lambrecht, Knud. 1996. Toward a construction-based theory of language function: The case of nominal extraposition. *Language* 72: 215–247.
- [64] Murphy, Gregory. 2002. *The Big Book of Concepts*. Cambridge: Massachusetts Institute of London.
- [65] Onnis, Luca. and Christiansen, Morten. H. 2008. Lexical categories at the edge of the word. *Cognitive Science* 32: 184–221.
- [66] Patten, Amanda. 2013. *The English IT-cleft: A constructional account and a diachronic investigation*. Berlin: Walter de Gruyter.
- [67] Pullum, Geoffrey. K. 2009. Lexical categorisation in English dictionaries and traditional grammars. *Zeitschrift für Anglistik und Amerikanistik* 57: 255–273.
- [68] Pullum, Geoffrey. K. and Huddleston, Rodney. 2002. Prepositions and preposition phrases. In R. Huddleston and G. K. Pullum (eds.). *The Cambridge Grammar of the English Language*, 589–653. Cambridge: Cambridge University Press.
- [69] Quirk, Randolph., Greenbaum, Sidney. and Leech, Geoffrey. and Svartvik, Jan. 1985. *A Comprehensive Grammar of the English Language*. London: Pearson Education.
- [70] Radford, Andrew. 1997. *Syntactic Theory and the Structure of English: A minimalist approach*. Cambridge: Cambridge University Press.
- [71] Rauh, Gisa. 1993. On the grammar of lexical and non-lexical prepositions in English. In Aurnague, M. and Vieu, L. (eds.). *The Semantics of Prepositions*, 99–150. New York: Mouton de Gruyter.
- [72] Rauh, Gisa. 2010. *Syntactic Categories: Their Identification and Description in Linguistic Theories*. Oxford: Oxford University Press.
- [73] Redington, Martin., Crater, Nick. and Finch, Steven. 1998. Distributional Information: A powerful cue for acquiring syntactic categories. *Cognitive Science* 22 (4), 425–469.
- [74] Rosch, Eleanor. H. 1973. Natural categories. *Cognitive psychology* 4: 328–350.
- [75] Rosenbaum, Peter. S. 1967. *The Grammar of English Predicate Complement Constructions*. Cambridge: MIT Press.
- [76] Safir, Ken. 1983. On small clauses as constituents. *Linguistic Inquiry* 14: 730–735.
- [77] Sag, Ivan. A., Boas, Hans. and Kay, Paul. 2012. Introducing sign-based construction grammar. In H. Boas and I. A. Sag (eds.). *Sign-based Construction Grammar*. Stanford: CSLI Publications: 1–30.
- [78] Seppänen, Aimo., Bowen, Rhonwen. and Trotta, Joe. 1994. On the so-called complex prepositions. *Studia Anglia Posnaniensia* 1: 3–29.
- [79] Snider, T. 2010. The Semantics of Prepositions: An exploration into the uses of “at” and “to”. Available at http://scholar.google.co.in/scholar?q=the+semantics+of+prepositions%3A+an+exploration+into+the+uses+od+at+and+to&btnG=&hl=en&as_sdt=0%2C5. [Accessed 21st September 2015].
- [80] Snyder, William. 2001. On the nature of syntactic variation: Evidence from complex predicates and complex word-formation. *Language* 77: 324–342.
- [81] Stowell, Timothy. A. 1981. *Origins of Phrase Structure*. Ph.D. Cambridge: Massachusetts Institute of Technology.
- [82] Taylor, J. R. 1998. Syntactic constructions as prototype categories. In M. Tomasello (ed.). *The New Psychology of Language: Cognitive and functional approaches to language structure*, 177–202. London: Lawrence Erlbaum Associates.

- [83] Taylor, John. R. 2003. *Linguistic Categorisation*. (Third edition) Oxford: Oxford University Press.
- [84] Taylor, John. R. 2012. *The Mental Corpus: How language is represented in the mind*. Oxford: Oxford University Press.
- [85] Thomson, A. J., Martinet, A.V. and Draycott, E. 1986. *A practical English Grammar*. Oxford: Oxford University Press.
- [86] Trask, R. L. 1992. *A Dictionary of Grammatical Terms in Linguistics*. Routledge: New York.
- [87] Traugott, E. 2008. The grammaticalization of NP of NP patterns. In A. Bergs and G. Diewald (eds.). *Constructions and Language Change*, 21–43. Berlin: Walter de Gruyter.
- [88] Tuggy, David. 2007. Schematicity. In D. Geeraerts and H. Cuyckens (eds.). *The Oxford Handbook of Cognitive Linguistics*, 82–116. Oxford: Oxford University Press.
- [89] Valeika, Laimutis. and Buitkiene, Janina. 2003. *An Introductory Course in Theoretical English Grammar*. Lithuania: Vilnius Pedagogical University.
- [90] Van der Auwera, Johan. and Gast, Volker. 2011. Categories and prototypes. In J. van der Auwera and V. Gast (eds.). *The Oxford Handbook of Typology*, 166–189. Oxford: Blackwell.
- [91] Weber, David. 2012. *English Prepositions: A historical survey*. MA. Masaryk University.
- [92] Wierzbicka, Anna. 1988. *The Semantics of Grammar*. Amsterdam: John Benjamins Publishing.

Appendices

Appendix 1. The list of precomps investigated in the current paper

for fear, in order, on (the) condition, as to, as for, for all, as soon as, as long as, in case, in the event, on the basis, on the ground(s), to the effect, all over, in two minds, here, there, now, upstairs, downstairs, uphill, downhill, upstage, downstage, upstream, downstream, overseas, overboard, overhead, overland, underfoot, underground, home, outdoors, indoors, , backward(s), forward(s), upward(s), downwards(s), inward(s), outward(s), eastward(s), northward(s), southward(s), westward(s), eastward(s), leftward(s), rightward(s), homeward(s), skyward(s), heavenward(s), seaward(s), abroad, adrift, aloft, aground, ashore, contrary, counter, exclusive, pursuant, subsequent, previous, preparatory, preliminary, prior, adjacent, unbeknown(st), further (reference), consequent, due, next, away, out, abreast, aboard, down, over, along, with, ahead, less ('minus'), thanks, owing, according, regarding, from, upon, because, although, whereas, via, when, where, until, after, before, whether, without, ago, into, onto, between, amid, among, against, beside, during, come, absent, counting, touching, respecting, concerning, considering, following, failing, barring, excluding, including, pending, excepting, turning, pertaining, bearing, having, given, granted, provided, providing, supposing, assuming, seeing, allowing, bar, except, if (interrogative), if (conditional) regardless besides, irrespective, apropos, but, albeit, of, notwithstanding, though, whenever, wherever, once (temporal), once (TIMES), unless, lest, whereupon, opposite, beyond, past, below, above, round, underneath, beneath, around, throughout, though, within, across, inside, behind, alongside, under, N.S.E.W., instead, minus, versus, per, gone (BrE), since (temporal), since (non-temporal), as (temporal), as (causative), on (locative), on (concerning), on (non-locative), off (locative), off (non-locative), outside (locative), outside (exception), in (locative), in (non-locative), that (purposive), that (empty), while (temporal), while (concessive), whilst (temporal), whilst (concessive), apart ("away"), aside ("away"), apart (exception), aside (exception), by (non-locative), by (locative), at, about (locative), about (concerning), worth, near, close, far

Appendix 2. The precomps whose syntactic structure is determined by their semantic meanings

<i>about</i> (movement)	e.g. ... as if I was holding the thought in my hands, looking at it, turning it <i>about</i> . [BNC A08 2936]
<i>about</i> (concerning)	e.g. To reduce the number of new HIV infections by giving young people the facts <i>about</i> AIDS. [BNC A00 419]
<i>apart</i> (exception)	e.g. <i>Apart</i> from art criticism and art history, there exist several other types of writing about art. [BNC A04 115]
<i>apart</i> ("away")	e.g. the functions and methods of the two sorts of writer have drawn <i>apart</i> . [BNC A04 81]
<i>as</i> (temporal)	e.g. An ACET-link will play a vital role <i>as</i> our work is growing so rapidly. [BNC A00 175]
<i>as</i> (causative)	e.g. <i>As</i> there is no Embassy of Taiwan in the UK, please do not copy any appeals to another embassy, as proposed on the letter writing page. [BNC A03 158]
<i>aside</i> (exception)	e.g. <i>Aside</i> from the technological requirements of the new system, other important issues have to be resolved. [BNC A1E 47]
<i>aside</i> ("away")	e.g. He pushed the pad <i>aside</i> , took a sip of orange juice, wiped his forehead, and went on typing. [BNC A08 488]
<i>by</i> (locative)	e.g. Philip found him <i>by</i> the door into the yard. [BNC ABX 2179]
<i>by</i> (non-locative)	e.g. <i>By</i> working co-operatively, long-term, with the people around me, I hope to continue for some time yet. [BNC A00 206]
<i>if</i> (interrogative)	e.g. <i>If</i> I can help further please do not hesitate to contact me on 081 840 7879 Peter Fabian Director of Fundraising. [BNC A00 78]
<i>if</i> (conditional)	e.g. I am asked if I can be on standby if transport is needed? [BNC A00 378]
<i>in</i> (locative)	e.g. She put the pen <i>in</i> her pocket.
<i>in</i> (non-locative)	e.g. Your Team has been invaluable <i>in</i> providing psychological as well as practical support for these patients which have been grossly lacking through the conventional channels. [BNC A01 584]
<i>off</i> (locative)	e.g. 'Oh, she can't get <i>off</i> the island,' he said. [BNC A0D 386]
<i>off</i> (non-locative)	e.g. Although suggestions of a Labour government are premature with an election possibly two years <i>off</i> ... [BNC A3W 452]
<i>on</i> (locative)	e.g. She put the cup <i>on</i> the table.
<i>on</i> (continuation)	e.g. She burred <i>on</i> . [Google Web]
<i>on</i> (concerning)	e.g. Despite the publicity <i>on</i> transmission of the disease, ignorance was such that they became afraid to even visit me. [BNC A02 95]



<i>once</i> (TIMES)	e.g. ... even if you do it only <i>once</i> . [BNC A01 132]
<i>once</i> (temporal)	e.g. <i>Once</i> flowers are over, cut the faded stems back to ground level. [BNC A0G 466]
<i>outside</i> (exception)	e.g. <i>Outside</i> of an unfortunate sermon, he never put a foot wrong. [Google Web]
<i>outside</i> (locative)	e.g. There was a girl <i>outside</i> the room.
<i>since</i> (temporal)	e.g. The rapid growth of ACET <i>since</i> its inception in 1988 has made the creation of this new post a priority. [BNC A00 294]
<i>since</i> (non-temporal)	e.g. <i>Since</i> black people in the southern states have suffered more injustices at the hands of the law they tend to be less likely to hand out death sentences. [BNC A03 718]
<i>that</i> (purposive)	e.g. They quickly offer their apologies, <i>that</i> they don't ruin their career. [Google Web]
<i>that</i> (empty)	e.g. ACET volunteers work as part of a team and provide help in many different ways to ensure <i>that</i> people don't spend time in hospital unnecessarily. [BNC A00 82]
<i>while</i> (concessive)	e.g. One person wants out, <i>while</i> the other wants the relationship to continue. [Google Web]
<i>while</i> (temporal)	e.g. In many cases a user will actually solve his or her own problem <i>while</i> on the phone to Neptune! [BNC A0C 632]
<i>whilst</i> (concessive)	e.g. <i>Whilst</i> the age of the theme pub may be over, more and more old pubs are being transformed into identical, pseudo-historical clones. [BNC A0B 75]
<i>whilst</i> (temporal)	e.g. She didn't want to talk <i>whilst</i> I was there, figuring maybe the line was tapped or something. [Google Web]

Appendix 3. Data for the internal and external syntax of precomps

In this appendix, I list all the syntactic items claimed to belong to the category of preposition or complementiser/subordinator and give examples of their internal and external syntactic distribution. For reliability of referencing, the corpus document IDs are added at the end of each example.

These data would be more reliable if more English linguists were sought for introspective judgement. The data collated for some properties, such as topicalisation, were probably deficient in some respect as it was gathered from only one English native speaker linguist. Clearly the intuitions of one individual linguist might be idiolectal in some cases.

Property 1: ‘Prepositional complement’

	The functional word	‘Prepositional complement’
1.	<i>with</i>	*
2.	<i>for fear</i>	It also explains why Mr Morita hastily withdrew his chapters of the book, <i>for fear</i> of the damage it might do to Sony's sales. [BNC ABH 499]
3.	<i>of</i>	*
4.	<i>in order</i>	*
5.	<i>on condition</i>	*
6.	<i>as to</i>	*
7.	<i>as for</i>	*
8.	<i>for all</i>	*
9.	<i>as soon as</i>	*
10.	<i>as long as</i>	*
11.	<i>in case</i>	<i>In case of</i> difficulty, further information is available from Wickes Building Supplies Ltd. [BNC A16 496]
12.	<i>in the event</i>	Try and think systematically about your actions <i>in the event of</i> a launch failure. [BNC A0H 76]
13.	<i>on the basis</i>	‘The Council must of course proceed <i>on the basis of</i> the vote,’ he said. [BNC A0R 1498]
14.	<i>on the grounds</i>	They had been quashed by Bow Street magistrates court earlier this year <i>on the grounds of</i> delay. [BNC AAU 507]
15.	<i>to the effect</i>	Frequently couples at their golden wedding celebration will say something <i>to the effect of</i> ‘we made it a point never to go to bed angry’. [BNC BND 1471]
16.	<i>all over</i>	The collapse of the Empire in 1814 and the fall of Napoleon I brought about a dispersal of the Imperial House and although the return of Napoleon from Elba in 1815 led to a restoration of the family fortunes, it was <i>all over</i> in the Hundred Days.
17.	<i>in two minds</i>	The poem, we might say, is <i>in two minds about</i> itself and its own meaning. [BNC A1B 1732]
18.	<i>here</i>	*
19.	<i>there</i>	*
20.	<i>now</i>	*
21.	<i>upstairs, downstairs</i>	*
22.	<i>uphill, downhill</i>	*
23.	<i>upstage, downstage</i>	*
24.	<i>upstream, downstream</i>	*
25.	<i>overseas, overboard, overhead, overland</i>	*
26.	<i>underfoot</i>	*
27.	<i>underground</i>	*
28.	<i>home</i>	*
29.	<i>outdoors, indoors</i>	*
30.	<i>back</i>	annoyed by the two three-and-out drives to start the third quarter that let Oakland get <i>back</i> in the game. [COCA, News Baltimore Sun]



	The functional word	'Prepositional complement'
31.	<i>backward(s), forward(s), upward(s), downward(s), inward(s), outward(s), eastward(s), northward(s), southward(s), westward(s), eastward(s), leftward(s), rightward(s), homeward(s), skyward(s), heavenward(s), seaward(s)</i>	*
32.	<i>abroad</i>	*
33.	<i>adrift</i>	*
34.	<i>aloft</i>	*
35.	<i>aground</i>	*
36.	<i>ashore</i>	*
37.	<i>contrary</i>	<i>Contrary</i> to her usual habit, she rang [sic] for a motorbike messenger. [BNC A6J 1722]
38.	<i>counter</i>	The current regime governing credit card transactions in the UK runs <i>country</i> to such basic trading practices and principles. [BNC AAJ 209]
39.	<i>exclusive</i>	Learn a new skill on one of our courses, <i>exclusive</i> to Ideal Home readers. [BNC C9X 941]
40.	<i>pursuant</i>	<i>Pursuant</i> to the promises made to Parliament, four commissioners were appointed on 30 March 1327, and sat at Chertsey to decide the fate of the Surrey part of Windsor Forest. [BNC AE9 787]
41.	<i>subsequent</i>	<i>Subsequent</i> to the first plan being drafted, three Spanish gas fields were discovered ... [BNC AT8 632]
42.	<i>previous</i>	<i>Previous</i> to my arrival in Sydney, I was at a stage of uncertainty as to what I did and did not believe. [BNC EVH 240]
43.	<i>preparatory</i>	The conference was <i>preparatory</i> to the second world climate conference in November 1990 [see p. 37874]. [BNC HL7 5063]
44.	<i>preliminary</i>	He recognised that there was general resentment of the oppressive conduct of the Forest officers, and made provision for regular inquiries into it, and for presentment of Forest offences to be made at the attachment courts, as a procedure <i>preliminary</i> to the Forest Eyre. [BNC AE9 716]
45.	<i>prior</i>	<i>Prior</i> to this incident, in April 1990 three Sri Lankan Tamils attempted to seek asylum in the UK. [BNC A03 935]
46.	<i>adjacent</i>	To the rear of the main block, <i>adjacent</i> to the old railway bridge, is a wide stone arch which was part of the installation. [BNC ANC 164]
47.	<i>unbeknown(st)</i>	Perhaps, <i>unbeknownst</i> to me, she had worked her way through graduate school pushing grand pianos down stairways, or dropkicking boxes of Wedgwood into waiting vans. [BNC B72 1761]
48.	<i>further</i> (reference)	<i>Further</i> to my letter of yesterday, I now am able to send you your copy of the OALDCE 3/e Electronic computer tape, which has been prepared to your specifications. [BNC AP1 303]
49.	<i>consequent</i>	'And, <i>consequent</i> to your failure, I doubt if I'll have any more intruders in my cloud.' [BNC GVL 3598]
50.	<i>due</i>	On 26 March 1991 he was returned to Safi Prison and in protest he began a hunger-strike which resulted in his falling into a coma, <i>due</i> to his illness, a few days later. [BNC A03 583]
51.	<i>next</i>	First of all, outside the city, <i>next</i> to a growth of forest, there is Thrushcross Grange. [BNC A05 26]
52.	<i>away</i>	And the fact that I soon got <i>away</i> from it. [BNC A08 398]
53.	<i>out</i>	7 <i>out</i> of 10 people infected are heterosexual. [BNC A00 17]
54.	<i>abreast</i>	In an attempt to keep <i>abreast</i> of current changes in care provision and in order to provide effective health care, many nurses are involved in identifying, setting and monitoring standards. [BNC CAP 1703]
55.	<i>aboard</i>	*
56.	<i>down</i>	It was a very long journey right across the Atlas mountains and <i>down</i> to the edge of the desert. [BNC A03 847]
57.	<i>up</i>	Dr Dixon said, 'With <i>up</i> to 20 years from infection to illness, we just have to ask how many of our congregation have been added during that time?' [BNC A00 134]
58.	<i>over</i>	How far the glider rolls <i>over</i> into the beginning of the spin depends to a large extent on the amount of yaw present. [BNC A0H 847]
59.	<i>along</i>	<i>Along with</i> the thousands of appeal letters sent as a result of Amnesty's campaign, perhaps the clearest direct pressure is being exerted by the Sri Lanka Aid Consortium, made up of donor governments and multi-lateral institutions. [BNC A03 765]
60.	<i>ahead</i>	Berger said: 'He made it to the first corner <i>ahead</i> of me and I tried to hang on.' [BNC A1N 69]



	The functional word	'Prepositional complement'
61.	<i>less</i> ('minus')	However, it is frequently used for long distance tows, because there is <i>less of</i> a tendency to get a slack rope during level flight in the low tow position. [BNC A0H 1301]
62.	<i>thanks</i>	Recently, <i>thanks to</i> legislation from the EC, all drinkers have to state their alcoholic strength by volume (ABV). [BNC A14 164]
63.	<i>owing</i>	<i>Owing to</i> the extremely high inflation there, prices are often quoted in Deutschmarks. [BNC A3T 450]
64.	<i>according</i>	Both full- and part-time work is carefully organised <i>according to</i> the availability and skills of each volunteer. [BNC A00 412]
65.	<i>regarding</i>	*
66.	<i>from</i>	*
67.	<i>upon</i>	*
68.	<i>because</i>	To be eligible for ACET Home Care you must be HIV positive and require assistance <i>because of</i> this. [BNC A01 486]
69.	<i>although</i>	*
70.	<i>whereas</i>	*
71.	<i>via</i>	*
72.	<i>when</i>	*
73.	<i>where</i>	*
74.	<i>until</i>	*
75.	<i>after</i>	*
76.	<i>before</i>	*
77.	<i>whether</i>	*
78.	<i>without</i>	*
79.	<i>ago</i>	*
80.	<i>into</i>	*
81.	<i>onto</i>	*
82.	<i>between</i>	*
83.	<i>amid</i>	*
84.	<i>among</i>	*
85.	<i>against</i>	*
86.	<i>beside</i>	*
87.	<i>during</i>	*
88.	<i>come</i>	*
89.	<i>absent</i>	*
90.	<i>counting</i>	*
91.	<i>touching</i>	Other essays continue this theme, <i>touching</i> on topics from green jobs [COCA, MAG EEnvironmental]
92.	<i>respecting</i>	*
93.	<i>concerning</i>	*
94.	<i>considering</i>	*
95.	<i>following</i>	Formerly a school, it has been converted into a country house hotel by Richard Broyd, <i>following</i> on from his earlier conversion of Middlethorpe Hall on the edge of York. [BNC AR9 758]
96.	<i>failing</i>	*
97.	<i>barring</i>	*
98.	<i>excluding</i>	*
99.	<i>including</i>	*
100.	<i>pending</i>	*
101.	<i>excepting</i>	<i>Excepting for</i> German reconnaissance aircraft which shadowed the convoy and a number of abortive U-boat attacks, we all arrived safely and I had my first run ashore in a foreign country. [BNC K46 32]
102.	<i>turning</i>	<i>Turning to</i> the White Paper, to be published before the next party conference, he said it would set out the Conservatives' agenda for the rest of this century. [BNC A50 623]
103.	<i>pertaining</i>	Ann Kussmaul, an historian, observes that evidence <i>pertaining to</i> discipline and resentment between masters and servants in husbandry comes almost entirely from masters. [BNC AN4 2531]
104.	<i>bearing</i>	* ⁸
105.	<i>having</i>	*
106.	<i>given</i>	*

⁸ The complement of *bearing* in bearing in mind that it takes approximately 12 weeks from planting to flowering, it is possible to grow bulbs of many species and varieties to flower at the same time for a spectacular display, and also plant for a succession of flowers if potting up is carefully timed [BNC A0G 684] is arguably a small clause complement.



	The functional word	'Prepositional complement'
107.	<i>granted</i>	*
108.	<i>provided</i>	*
109.	<i>providing</i>	*
110.	<i>supposing</i>	*
111.	<i>assuming</i>	*
112.	<i>seeing</i>	*
113.	<i>allowing</i>	<i>Allowing</i> for 120 proxy votes and some 50 people at the AGM, less than half the AFBF membership bothered to register their opinion. [BNC A3S 23]
114.	<i>bar</i>	*
115.	<i>except</i>	Agassiz discouraged the use of books, <i>except</i> for research work. [BNC A04 947]
116.	<i>if</i>	*
117.	<i>regardless</i>	This is true, <i>regardless</i> of the opinion that some people have of Syria, and of their unhappiness at Syria's presence in Lebanon. [BNC A1G 262]
118.	<i>besides</i>	*
119.	<i>irrespective</i>	This is true of all computers, whatever make, size or cost and <i>irrespective</i> of the programs you run on your machine. [BNC A0C 659]
120.	<i>apropos</i>	'They're doing to small-time corruption what the multinational corporations are doing to small-time business,' a cynical Sardinian friend had once remarked <i>apropos</i> of the latest initiative to dean up the police. [BNC HTT 2530]
121.	<i>but</i>	No doubt they mean well where the arts are concerned, he wrote, <i>but</i> for that reason they are the biggest menace. [BNC A08 2615]
122.	<i>albeit</i>	*
123.	<i>notwithstanding</i>	*
124.	<i>though</i>	*
125.	<i>whenever</i>	*
126.	<i>wherever</i>	*
127.	<i>once</i> (temporal)	*
128.	<i>once</i> (TIMES)	*
129.	<i>unless</i>	*
130.	<i>lest</i>	*
131.	<i>whereupon</i>	*
132.	<i>opposite</i>	Note that the rhythm of adrenalin is timed <i>opposite</i> to that of fatigue and the same as that of shooting speed. [BNC A75 496]
133.	<i>beyond</i>	*
134.	<i>past</i>	*
135.	<i>below</i>	*
136.	<i>above</i>	*
137.	<i>round</i>	With the lighter machines, the into-wind wing should be picketed or weighted with tyres or weights, and the tail-skid or wheel should be blocked to prevent the glider moving <i>round</i> into wind. [BNC A0H 180]
138.	<i>underneath</i>	*
139.	<i>beneath</i>	*
140.	<i>around</i>	The ability to move <i>around</i> in the competition area is essential if you are always going to be poised and ready either to attack or to respond. [BNC A0M 522]
141.	<i>throughout</i>	Unlike so many conservatives he had not compromised his position and was consistent <i>throughout</i> in his condemnation of Japan. [BNC EDP 93]
142.	<i>through</i>	The restaurant manager should also anticipate problems in the kitchen or front of house and prevent any 'ripples' getting <i>through</i> to the customer. [BNC A0C 1253]
143.	<i>within</i>	*
144.	<i>across</i>	The catering manager at Butler's contract is Neil Patterson — a chef who joined Compass six years ago and has since moved <i>across</i> into management. [BNC A0C 1353]
145.	<i>inside</i>	Windchills are so cold, the zoo animals were brought inside in Washington. [COCA, SPOK CNN New Day]
146.	<i>behind</i>	*
147.	<i>alongside</i>	Our practice for rest days was to find a safe harbour for the ship where she could be left <i>alongside</i> with two standby crew on board while the rest of the lads went home. [BNC H0C 1254]
148.	<i>under</i>	Finally, guberniia executive committees were charged with the resurrection of village reading-rooms, most of which had gone <i>under</i> in the changed economic conditions of NEP. [BNC A64 1712]
149.	N.S.E.W.	I've seen salamanders in green woods <i>north</i> of New York, with Jeff. [BNC A0U 232]
150.	<i>instead</i>	Claire was wearing stockings <i>instead</i> of socks that summer, and her legs looked funny. [BNC A0D 1636]
151.	<i>minus</i>	*



	The functional word	'Prepositional complement'
152.	<i>versus</i>	*
153.	<i>per</i>	*
154.	<i>gone</i> (BrE)	*
155.	<i>since</i> (temporal)	*
156.	<i>since</i> (non-temporal)	*
157.	<i>as</i> (temporal)	*
158.	<i>as</i> (causative)	*
159.	<i>on</i> (locative)	*
160.	<i>on</i> (concerning)	*
161.	<i>on</i> (non-locative)	The article as a whole is strangely lopsided but seems to follow <i>on</i> from the logic of this position. [BNC A07 747 http://bncweb.lancs.ac.uk/cgi-bin/bncXML/fileInfo.pl?text=A6V&urlTest=yes]
162.	<i>off</i> (locative)	This is all going to cut you <i>off</i> from London a bit, but I don't see that there's really any other way at the moment. [BNC A0F 3245]
163.	<i>off</i> (non-locative)	Having left Tony and his Mum at his appointment, I set <i>off</i> in the direction of the A4. [BNC A00 393]
164.	<i>outside</i> (locative)	Back <i>outside</i> in the competition area, I spied Becky with her parents huddled in a corner [COCA, FIC Bk: ArtHoldingOnLettingGo]
165.	<i>outside</i> (exception)	<i>Outside</i> of the dealerships, and there are only a few of these who understand the publishing process, a number of companies have established themselves as providers of independent advice, training and support. [BNC G00 1231]
166.	<i>in</i> (locative)	We lived for it, in between homes and restaurants. [BNC A0P 1030]
167.	<i>in</i> (non-locative)	*
168.	<i>that</i> (purposive)	*
169.	<i>that</i> (empty)	*
170.	<i>while</i> (temporal)	*
171.	<i>while</i> (concessive)	*
172.	<i>whilst</i> (temporal)	*
173.	<i>whilst</i> (concessive)	*
174.	<i>apart</i> ('away')	Before then, he had never spent a night <i>apart</i> from his extended family. [COCA, News Omaha World-Herald 2017]
175.	<i>aside</i> ('away')	His pupil, perhaps <i>aside</i> from talent and position, is his antithesis. [COCA, News New York Pos 2017]
176.	<i>apart</i> (exception)	<i>Apart</i> from the 4-SUBS, traffic levels meant there was little chance for stock to fall out of the bottom of the cascade. [BNC A11 1611]
177.	<i>aside</i> (exception)	<i>Aside</i> from the palace, the Russians, like Ozymandias, has left precious little spoor. [BNC ABS 618]
178.	<i>by</i> (non-locative)	*
179.	<i>by</i> (locative)	*
180.	<i>at</i>	*
181.	<i>about</i> (locative)	*
182.	<i>about</i> (concerning)	*
183.	<i>worth</i>	*
184.	<i>near</i>	The latrine situated <i>near</i> to the road at the far end of the orchard has been moved to the other side, as far as possible from the road, due to the increasing mortaring. [BNC A61 1367]
185.	<i>close</i>	The female head louse lays shiny yellow eggs and glues them one by one to individual hairs, <i>close</i> to the scalp. [BNC A0J 1178]
186.	<i>far</i>	that is <i>far</i> from one's experience in front of it ... [BNC A04 1002]

Property 2: No/Null NP complement

	The functional word	No/Null comp
1.	<i>with</i>	*
2.	<i>for fear</i>	*
3.	<i>of</i>	*
4.	<i>in order</i>	*
5.	<i>on condition</i>	*
6.	<i>as to</i>	*
7.	<i>as for</i>	*
8.	<i>for all</i>	*
9.	<i>as soon as</i>	*
10.	<i>as long as</i>	*
11.	<i>in case</i>	Best to check your trolley, just <i>in case</i> . [BNC A0F 801]
12.	<i>in the event</i>	*
13.	<i>on the basis</i>	*
14.	<i>on the grounds</i>	*
15.	<i>to the effect</i>	*
16.	<i>all over</i>	I was looking for you <i>all over</i> . [BNC A7J 1521]
17.	<i>in two minds</i>	He is <i>in two minds</i> . [BNC A05 690]
18.	<i>here</i>	There is no prison <i>here</i> . [BNC: A03 849]
19.	<i>there</i>	having been in the US's 'back yard' I know how little attention is paid to those issues <i>there</i> . [BNC: A03 700]
20.	<i>now</i>	I would like to be an ACET volunteer so what do I do <i>now</i> ? [BNC: A00 109]
21.	<i>upstairs, downstairs</i>	She strolled <i>upstairs</i> . [BNC A0L 3556]
22.	<i>uphill, downhill</i>	Cross the bridge and go <i>uphill</i> . [BNC CHK 1733]
23.	<i>upstage, downstage</i>	... jump, turn and move <i>downstage</i> . [BNC KAG 112]
24.	<i>upstream, downstream</i>	He gazed <i>downstream</i> . [BNC B3J 2041]
25.	<i>overseas, overboard, overhead, overland</i>	Projecting and protecting British interests <i>overseas</i> . [BNC ABA 50]
26.	<i>underfoot</i>	Non-slip wax is used to help your grip <i>underfoot</i> . [BNC AT6 2213]
27.	<i>underground</i>	When it comes to the disposal of slurry, farmers are going <i>underground</i> . [BNC ACR 3063]
28.	<i>home</i>	I decided that the best thing to do was to go <i>home</i> . [BNC A0F 271]
29.	<i>outdoors, indoors</i>	The principal reason the council became involved in competitions in 1988 was to control them and to prevent events taking place <i>outdoors</i> . [BNC A15 104]
30.	<i>back</i>	He handed it <i>back</i> . [BNC A08 1687]
31.	<i>backward(s), forward(s), upward(s), downward(s), inward(s), outward(s), eastward(s), northward(s), southward(s), westward(s), eastward(s), leftward(s), rightward(s), homeward(s), skyward(s), heavenward(s), seaward(s)</i>	She ran <i>backwards</i> . [BNC ADF 1183]
32.	<i>abroad</i>	Foreigners may be all right <i>abroad</i> but we don't want none of them and their ways here. [BNC A0D 594]
33.	<i>adrift</i>	Now, <i>adrift</i> from home and more vulnerable than ever, he discovered in himself a remarkable gift for inspiring friendship, a gift which never left him. [BNC B0R 117]
34.	<i>aloft</i>	The congregation sways, hands <i>aloft</i> . [BNC ABK 1740]
35.	<i>aground</i>	A year later, the vessel was still firmly <i>aground</i> . [BNC ABC 1662]
36.	<i>ashore</i>	She'd say, moreover, that you could always get out of a boat and go <i>ashore</i> , but from that height you could only crash. [BNC A05 712]
37.	<i>contrary</i>	*
38.	<i>counter</i>	*
39.	<i>exclusive</i>	*
40.	<i>pursuant</i>	*
41.	<i>subsequent</i>	*
42.	<i>previous</i>	*
43.	<i>preparatory</i>	*
44.	<i>preliminary</i>	*
45.	<i>prior</i>	*
46.	<i>adjacent</i>	*
47.	<i>unbeknown(st)</i>	*



	The functional word	No/Null comp
48.	<i>further</i> (reference)	*
49.	<i>consequent</i>	*
50.	<i>due</i>	*
51.	<i>next</i>	When Roger Collins was sentenced to death aged 18 he had no idea what would happen <i>next</i> . [BNC A03 730]
52.	<i>away</i>	Nearly all the stone steps in the first flight up to the half-landing were broken, with jagged edges where bits of tread had fallen <i>away</i> . [BNC A05 359]
53.	<i>out</i>	Gianni and Ursula leapt on just as the doors were closing, but Monique, who was now a few yards behind them and whose movements were hampered anyway by her arthritis, was left standing there as the train moved <i>out</i> . [BNC A05 871]
54.	<i>abreast</i>	He could think of no form of words, no common interest which could provide a path down which they could all three go <i>abreast</i> . [BNC HA2 1534]
55.	<i>aboard</i>	Put my baggage <i>abroad</i> . [BNC ACE 3633]
56.	<i>down</i>	I looked <i>down</i> . [BNC A08 2683]
57.	<i>up</i>	Do not look <i>up</i> . [BNC A08 1589]
58.	<i>over</i>	It is worthwhile designing trailer fittings so that the glider is held firmly in place even if the trailer rolls <i>over</i> . [BNC A0H 320]
59.	<i>along</i>	Lift yourself off the ground as you go <i>along</i> . [BNC A1F 60]
60.	<i>ahead</i>	Instead, you should simply level out and land <i>ahead</i> . [BNC A0H 688]
61.	<i>less</i> ('minus')	*
62.	<i>thanks</i>	*
63.	<i>owing</i>	*
64.	<i>according</i>	*
65.	<i>regarding</i>	*
66.	<i>from</i>	*
67.	<i>upon</i>	*
68.	<i>because</i>	*
69.	<i>although</i>	<i>Although</i> , at that moment I could have done with a little less myself. [BNC A0D 1707]
70.	<i>whereas</i>	*
71.	<i>via</i>	*
72.	<i>when</i>	*
73.	<i>where</i>	*
74.	<i>until</i>	*
75.	<i>after</i>	She died soon <i>after</i> . [BNC A6V 1714]
76.	<i>before</i>	More autocratic and more absentee than <i>before</i> . [BNC A06 2370]
77.	<i>whether</i>	*
78.	<i>without</i>	They go to all that trouble to feed strangers and then expect their own family to do <i>without</i> . [BNC A0D 1906]
79.	<i>ago</i>	There are not the chances around these days as there were some years <i>ago</i> . [BNC A06 2156]
80.	<i>into</i>	*
81.	<i>onto</i>	*
82.	<i>between</i>	And Lucy's silky warm skin all along her, arms wrapped round each other, so close that nothing could come <i>between</i> . [BNC A0L 214]
83.	<i>amid</i>	*
84.	<i>among</i>	*
85.	<i>against</i>	If two Cambridge electors voted <i>against</i> , that must mean that the faculty divided about Ramsey. [BNC A68 1707]
86.	<i>beside</i>	*
87.	<i>during</i>	*
88.	<i>come</i>	*
89.	<i>absent</i>	*
90.	<i>counting</i>	*
91.	<i>touching</i>	*
92.	<i>respecting</i>	*
93.	<i>concerning</i>	*
94.	<i>considering</i>	He thanked Mitch again for the tattoo and said it was lasting pretty well, <i>considering</i> . [BNC C86 2696] ⁹
95.	<i>following</i>	*
96.	<i>failing</i>	*
97.	<i>barring</i>	*
98.	<i>excluding</i>	*
99.	<i>including</i>	*

⁹ *Considering* can occur with a complement in colloquial varieties of English when it functions as postadverbial.



	The functional word	No/Null comp
100.	<i>pending</i>	*
101.	<i>excepting</i>	*
102.	<i>turning</i>	*
103.	<i>pertaining</i>	*
104.	<i>bearing</i>	*
105.	<i>having</i>	*
106.	<i>given</i>	*
107.	<i>granted</i>	<i>Granted</i> . Vitor continued to blame her, but it represented some kind of progress. [BNC JY9 1981]
108.	<i>provided</i>	*
109.	<i>providing</i>	*
110.	<i>supposing</i>	*
111.	<i>assuming</i>	*
112.	<i>seeing</i>	*
113.	<i>allowing</i>	*
114.	<i>bar</i>	*
115.	<i>except</i>	*
116.	<i>if</i>	*
117.	<i>regardless</i>	Even when I'm injured I think I can do it <i>regardless</i> . [BNC A5U 576]
118.	<i>besides</i>	I like — I'd like — to smoothe his eyebrows with my tongue and maybe more <i>besides</i> . [BNC AOU 2087]
119.	<i>irrespective</i>	*
120.	<i>apropos</i>	*
121.	<i>but</i>	*
122.	<i>albeit</i>	<i>Albeit</i> , Renee's fame throughout the locality had been assured that night. [BNC B3J 854]
123.	<i>notwithstanding</i>	Lewes managed to thrive <i>notwithstanding</i> . [BNC CB6 614]
124.	<i>though</i>	There are important differences, <i>though</i> . [BNC A05 1576]
125.	<i>whenever</i>	we don't increase the allocation, when he gets to sixty, or sixty five or <i>whenever</i> . [BNC JK7 428]
126.	<i>wherever</i>	Dublin people dress more individually than people in London or <i>wherever</i> . [BNC ACN 960]
127.	<i>once</i> (temporal)	*
128.	<i>once</i> (TIMES)	even if you only do it <i>once</i> . [BNC A01 132]
129.	<i>unless</i>	*
130.	<i>lest</i>	*
131.	<i>whereupon</i>	*
132.	<i>opposite</i>	He was thinking of settling in this land of freedom, he told me as I sat down <i>opposite</i> . [BNC AE0 1719]
133.	<i>beyond</i>	Making no attempt to answer, she turned to him and seemed to look into his eyes and <i>beyond</i> . [BNC ACV 1879]
134.	<i>past</i>	It's even bigger than the buses that go <i>past</i> . [BNC A74 2831]
135.	<i>below</i>	Some of the key plants are described in more detail <i>below</i> . [BNC A0G 2053]
136.	<i>above</i>	These lifts go up through the ceiling into the room <i>above</i> . [BNC A0J 1943]
137.	<i>round</i>	Beat back a pawn storm on Queen side and eventually turned it <i>round</i> . [BNC A08 416]
138.	<i>underneath</i>	... with a satin body <i>underneath</i> . [BNC A7N 213]
139.	<i>beneath</i>	Another stone dropped and splashed in the darkness <i>beneath</i> . [BNC A73 241]
140.	<i>around</i>	She would look odd carrying it <i>around</i> . [BNC A0R 2788]
141.	<i>throughout</i>	Confidentiality is maintained <i>throughout</i> . [BNC ALW 2523]
142.	<i>through</i>	Instead, my glass will be a lens to see the rest <i>through</i> . [BNC A08 1042]
143.	<i>within</i>	You fear death, the annihilation of self, but often you are already dead <i>within</i> . [BNC B21 1063]
144.	<i>across</i>	I walk up all the escalators I come <i>across</i> . [BNC A0R 1238]
145.	<i>inside</i>	Shouted that he knew I was <i>inside</i> . [BNC A08 3026]
146.	<i>behind</i>	We seemed to have left the world <i>behind</i> . [BNC A15 375]
147.	<i>alongside</i>	It escaped my notice, and was to my embarrassment, that the Land Rover was driving <i>alongside</i> . [BNC AT3 2331]
148.	<i>under</i>	Tunnels and bridges must be high enough for the train to go <i>under</i> . [BNC BNG 1884]
149.	N.S.E.W.	Below and behind Ann, John and Tony moved east and <i>north</i> . [BNC A6T 745]
150.	<i>instead</i>	We could listen to music <i>instead</i> . [BNC A0R 1029]
151.	<i>minus</i>	*
152.	<i>versus</i>	*
153.	<i>per</i>	Seven hundred rounds <i>per</i> , at two and three-quarter thousand f.p.s. [BNC HR7 2993]
154.	<i>gone</i> (BrE)	*
155.	<i>since</i> (temporal)	This was in September 1989 and he has been in prison <i>since</i> . [BNC A03 653]
156.	<i>since</i> (non-temporal)	*
157.	<i>as</i> (temporal)	*
158.	<i>as</i> (causative)	*
159.	<i>on</i> (locative)	It was obvious that France was determined to keep the lid <i>on</i> . [BNC EFA 78]
160.	<i>on</i> (concerning)	*



	The functional word	No/Null comp
161.	on (non-locative)	It didn't stop me going <i>on</i> , but it stopped him. [BNC A08 829]
162.	off (locative)	*
163.	off (non-locative)	The difficult calculations there beginning to pay <i>off</i> . [BNC A08 2597]
164.	outside (locative)	I stayed in the café for as long as I felt I could and then went back <i>outside</i> . [BNC A0F 2342]
165.	outside (exception)	*
166.	in (locative)	'Come <i>in</i> !' he shouted from within. [BNC A0F 75]
167.	in (non-locative)	*
168.	that (purposive)	*
169.	that (empty)	*
170.	while (temporal)	*
171.	while (concessive)	*
172.	whilst (temporal)	*
173.	whilst (concessive)	*
174.	apart ('away')	The pretense fell <i>apart</i> . [BNC A0U 2364]
175.	aside ('away')	Leave them <i>aside</i> . [BNC A0N 1449]
176.	apart (exception)	*
177.	aside (exception)	*
178.	by (non-locative)	*
179.	by (locative)	A yellow leaf floated <i>by</i> , and she imagined herself alongside it. [COCA FIC BkSnowChildNovel 2012]
180.	at	*
181.	about (locative)	as if I was holding the thought in my hands, looking at it, turning it <i>about</i> . [BNC A08 2936]
182.	about (concerning)	*
183.	worth	*
184.	near	Read Mr Adzhubey and you sense a Khrushchev who, at 70, knew that his end was <i>near</i> . [BNC A5M 192]
185.	close	She had always felt insulated from pain with him, as if the condoms served to forever prevent them from getting unhealthily <i>close</i> . [BNC A0U 914]
186.	far	Even if I might have wandered away from Piccadilly, I couldn't have gone <i>far</i> , and anyway I didn't mind walking. [BNC A0U 1937]



Property 3: NP complement

	The functional word	NP Comp
1.	<i>with</i>	Many people <i>with</i> AIDS have to spend long periods of time in hospital unless there is someone at home who can help and look after them. [BNC A00 81]
2.	<i>for fear</i>	*
3.	<i>of</i>	Shopping including collection <i>of</i> prescriptions. [BNC A00 86]
4.	<i>in order</i>	*
5.	<i>on condition</i>	*
6.	<i>as to</i>	<i>As to truth</i> and beauty — the truth can doubtless be beautiful, though it need not be. [BNC A6U 691]
7.	<i>as for</i>	<i>As for</i> a varied painter, only one work is likely to appear in a survey. [BNC A04 433]
8.	<i>for all</i>	In addressing itself to such possibilities, however, A Bend in the River , <i>for all</i> its air of simplicity, is never simple. [BNC A05 144]
9.	<i>as soon as</i>	*
10.	<i>as long as</i>	*
11.	<i>in case</i>	*
12.	<i>in the event</i>	*
13.	<i>on the basis</i>	*
14.	<i>on the grounds</i>	*
15.	<i>to the effect</i>	*
16.	<i>all over</i>	He has asked questions <i>all over</i> the village ... [BNC A0D 712]
17.	<i>in two minds</i>	*
18.	<i>here</i>	*
19.	<i>there</i>	*
20.	<i>now</i>	*
21.	<i>upstairs, downstairs</i>	*
22.	<i>uphill, downhill</i>	*
23.	<i>upstage, downstage</i>	*
24.	<i>upstream, downstream</i>	*
25.	<i>overseas, overboard, overhead, overland</i>	*
26.	<i>underfoot</i>	*
27.	<i>underground</i>	*
28.	<i>home</i>	*
29.	<i>outdoors, indoors</i>	*
30.	<i>back</i>	*
31.	<i>backward(s), forward(s), upward(s), downward(s), inward(s), outward(s), eastward(s), northward(s), southward(s), westward(s), eastward(s), leftward(s), rightward(s), homeward(s), skyward(s), heavenward(s), seaward(s)</i>	*
32.	<i>abroad</i>	*
33.	<i>adrift</i>	*
34.	<i>aloft</i>	*
35.	<i>aground</i>	*
36.	<i>ashore</i>	*
37.	<i>contrary</i>	*
38.	<i>counter</i>	*
39.	<i>exclusive</i>	*
40.	<i>pursuant</i>	*
41.	<i>subsequent</i>	*
42.	<i>previous</i>	*
43.	<i>preparatory</i>	*



	The functional word	NP Comp
44.	<i>preliminary</i>	*
45.	<i>prior</i>	*
46.	<i>adjacent</i>	The claim a tower provided with means <i>adjacent</i> the lower end thereof for supporting it within a vertical open shaft of the structure [COCA ACAD MechanicalEng 2009]
47.	<i>unbeknown(st)</i>	*
48.	<i>further</i> (reference)	*
49.	<i>consequent</i>	*
50.	<i>due</i>	*
51.	<i>next</i>	*
52.	<i>away</i>	*
53.	<i>out</i>	she'd spent most of her class time staring <i>out</i> windows, imagining herself in some far-off place. [COCA, FIC Bk:LostLake]
54.	<i>abreast</i>	*
55.	<i>aboard</i>	Career opportunities <i>aboard</i> cruise ships. [BNC HX3 417]
56.	<i>down</i>	I slowly made my way <i>down</i> the road. [BNC A0F 1343]
57.	<i>up</i>	Jack and Jill went <i>up</i> the hill to fetch a pail of water, Jack fell down and broke his crown and Jill came tumbling after. [BNC A0D 279]
58.	<i>over</i>	He subsequently received a discount of just <i>over</i> £50 after complaining about the telephone charge. [BNC A0C 221]
59.	<i>along</i>	Cars spread pollution, and scatter development <i>along</i> roads. [BNC A3W 383]
60.	<i>ahead</i>	*
61.	<i>less</i> ('minus')	The Corrado not only has a little more power and torque, it also benefits from about 170ib <i>less</i> bulk. [BNC A6W 734]
62.	<i>thanks</i>	*
63.	<i>owing</i>	*
64.	<i>according</i>	*
65.	<i>regarding</i>	<i>Regarding</i> sea freight, the company represents the Royal Dutch Nedlloyd Group offering services to the Middle East, North and South America, the Caribbean and Australia. [BNC AMH 549]
66.	<i>from</i>	The chance of <i>getting</i> infected <i>from</i> a pint of blood is less than 1 in a million. [BNC A01 26]
67.	<i>upon</i>	The impact <i>upon</i> the personality expectations and the way of life of a mature scholar by the University experience is not appreciated by many of the police ... [BNC A0K 376]
68.	<i>because</i>	*
69.	<i>although</i>	*
70.	<i>whereas</i>	*
71.	<i>via</i>	Chefs are very easy to identify because they actually make a statement <i>via</i> their food. [BNC A0C 1238]
72.	<i>when</i>	*
73.	<i>where</i>	*
74.	<i>until</i>	He was arrested shortly after his arrival and was detained without trial <i>until</i> September when he was sentenced to ten years' hard labour for alleged espionage. [BNC A03 667]
75.	<i>after</i>	<i>After</i> some time the student would return to report. [BNC A04 949]
76.	<i>before</i>	With a payment under covenant, The Deed of Covenant has to be filled in corrected <i>before</i> a payment is made. [BNC A01 344]
77.	<i>whether</i>	*
78.	<i>without</i>	<i>Without</i> their commitment we would not be able to provide such an extensive service. [BNC A01 525]
79.	<i>ago</i>	*
80.	<i>into</i>	Why do people get <i>into</i> drugs? [BNC A01 98]
81.	<i>onto</i>	GRiD Pad uses a light pen to 'write' data directly <i>onto</i> the screen. [BNC A0C 773]
82.	<i>between</i>	You can be infected for <i>between</i> 10–15 years without realising it. [BNC A00 16]
83.	<i>amid</i>	The proposal came <i>amid</i> fears that the Ministry of Agriculture might introduce tougher restrictions or even an outright ban. [BNC A59 467]
84.	<i>among</i>	<i>Among</i> the sources she will find are critical reviews, articles, catalogues and books about New York painting of the 1940s and 1950s, which will remind her that Pollock died in 1956. [BNC A04 48]
85.	<i>against</i>	In November 1990 he had been arrested in connection with a protest by women in Riyadh <i>against</i> a ban on women drivers. [BNC A03 242]
86.	<i>beside</i>	Was there a wind to swing the great plantation bell which he had brought home and hung on the oak <i>beside</i> the east gate? [BNC A0N 467]
87.	<i>during</i>	At the present rate of referral, numbers are more than set to double <i>during</i> the year. [BNC A00 287]
88.	<i>come</i>	Follow these three exercises every day and <i>come</i> summer you'll be in great shape. [BNC A70 1052]
89.	<i>absent</i>	<i>Absent</i> Subpart F, the code would permit deferral with respect to all foreign earnings ... [COCA FIC TaxManagement]



	The functional word	NP Comp
90.	<i>counting</i>	<i>Counting</i> pensioners and children, 14m savers should not be paying tax, but have to under current legislation. [BNC ABF 1880]
91.	<i>touching</i>	'The epileptic' makes a neat reply, again <i>touching</i> life and art simultaneously: the author and hero of The Idiot. [BNC A18 794]
92.	<i>respecting</i>	The sergeant began to have serious worries <i>respecting</i> his car, which was parked round the corner, an open street map of Mansfield on the passenger seat. [BNC C8D 3119]
93.	<i>concerning</i>	The directive included advisory regulations <i>concerning</i> building requirements, kitchen equipment, food waste, water supply, personal hygiene and production hygiene, but is not specific about those regulations or their implementation. [BNC A0C 1091]
94.	<i>considering</i>	<i>Considering</i> the success of Flexible Friends, it's a bit strange that Wild Country say they need to develop a twin wire camming device. [BNC A15 1148]
95.	<i>following</i>	<i>Following</i> the terminology of Patterson (1982), these two systems are said to involve either 'assembled' or 'addressed' phonology. [BNC A0T 1095]
96.	<i>failing</i>	<i>Failing</i> payment of the £30 the Company's promise would fall to the ground. [BNC B2S 1338]
97.	<i>barring</i>	<i>Barring</i> market collapse, they should retain their premium. [BNC A5G 247]
98.	<i>excluding</i>	Even <i>excluding</i> bonuses, British top managers beat their French, German and Dutch counterparts with a 12.1 per cent hike in basic pay ... [BNC A2H 370]
99.	<i>including</i>	Illnesses, <i>including</i> chronic muscle debility, herpes, tremors and eye infections, have come and gone. [BNC A00 331]
100.	<i>pending</i>	Mr Bakker was released on bail <i>pending</i> his sentencing, on 24 October. [BNC A2X 316]
101.	<i>excepting</i>	There are wide oak or elm floorboards in every room <i>excepting</i> the hall, which is stone flagged and from which rises a thick oak staircase with fat bannisters.
102.	<i>turning</i>	*
103.	<i>pertaining</i>	*
104.	<i>bearing</i>	*
105.	<i>having</i>	*
106.	<i>given</i>	<i>Given</i> the changes in the film industry world wide, do critics have an influence in determining box office, taste and value? [BNC A0E 533]
107.	<i>granted</i>	<i>Granted</i> the intriguing premise, one might reasonably expect some attempt to probe the morality of a privatised police force, and of a society which allows someone like Kuffs to buy and use firearms as casually as he does here, but no. [BNC AHG 1295]
108.	<i>provided</i>	*
109.	<i>providing</i>	*
110.	<i>supposing</i>	*
111.	<i>assuming</i>	Marcelo Ferrante raises some novel claims about the deterrent force differential punishment could incidentally serve <i>assuming</i> a number of sociological conditions and cognitive biases ... [COCA, ACAD Vanderbilt Law Review]
112.	<i>seeing</i>	*
113.	<i>allowing</i>	*
114.	<i>bar</i>	the album was mixed <i>bar</i> one track, which he did somewhere else. [BNC AB5 1726]
115.	<i>except</i>	The HMI does not inspect universities, <i>except</i> teacher training departments, by invitation. [BNC A30 463]
116.	<i>if</i>	*
117.	<i>regardless</i>	*
118.	<i>besides</i>	<i>Besides</i> women he was pursued by financial scandals. [BNC A0U 2391]
119.	<i>irrespective</i>	*
120.	<i>apropos</i>	*
121.	<i>but</i>	*
122.	<i>albeit</i>	In the case of the low potencies, that is, those below the 12C potency, material doses, <i>albeit</i> small ones, are present. [BNC C9V 469]
123.	<i>notwithstanding</i>	<i>Notwithstanding</i> this promise, the use of road pricing to change travel habits still seems some way off. [BNC A2L 73]
124.	<i>though</i>	*
125.	<i>whenever</i>	*
126.	<i>wherever</i>	*
127.	<i>once (temporal)</i>	*
128.	<i>once (TIMES)</i>	He taught <i>once</i> a week in the primary school and felt a failure at it. [BNC A68 1305]
129.	<i>unless</i>	*
130.	<i>lest</i>	*
131.	<i>whereupon</i>	*
132.	<i>opposite</i>	The ornate mirror was firmly fixed on the wall <i>opposite</i> the fireplace. [BNC A0R 1013]
133.	<i>beyond</i>	... a number have been held <i>beyond</i> the 72-hour-limit. [BNC A03 123]
134.	<i>past</i>	I tried to run <i>past</i> him but he grabbed the collar of my coat. [BNC A0D 1868]
135.	<i>below</i>	Add water to just <i>below</i> the base of the bulbs. [BNC A0G 702]



	The functional word	NP Comp
136.	<i>above</i>	I was thought to be getting <i>above</i> myself because I refused to sight read a scene. [BNC A06 2274]
137.	<i>round</i>	Soon I was <i>round</i> the corner again and on my way back to the station. [BNC A0F 1354]
138.	<i>underneath</i>	And <i>underneath</i> these feelings he felt some hot, dark stirrings in himself. [BNC A0N 1005]
139.	<i>beneath</i>	Quickening, the earth slipping <i>beneath</i> our feet. [BNC A0U 1215]
140.	<i>around</i>	<i>Around</i> the world today, more than 100 countries still retain the death penalty ... [BNC A03 316]
141.	<i>throughout</i>	Classes are carefully time-tabled <i>throughout</i> the day, and occasionally stretch into the evenings. [BNC A06 1316]
142.	<i>through</i>	To prevent new HIV infections <i>through</i> a schools education programme. [BNC A02 41]
143.	<i>within</i>	... the main critical writing is <i>within</i> 136 pages ... [BNC A04 1015]
144.	<i>across</i>	Its shadow passes <i>across</i> the glass. [BNC A08 651]
145.	<i>inside</i>	But are things any different <i>inside</i> our culture? [BNC A08 1467]
146.	<i>behind</i>	however, other prominent prisoners of conscience remain <i>behind</i> bars. [BNC A03 62]
147.	<i>alongside</i>	This is aimed at independent hotels, and will put them <i>alongside</i> chain properties on travel agents' terminals. [BNC A0C 530]
148.	<i>under</i>	The money was part of the proceeds from the sale of unclaimed property sold <i>under</i> the Police Property Act. [BNC A00 246]
149.	N.S.E.W.	*
150.	<i>instead</i>	*
151.	<i>minus</i>	That same evening, their corpses — <i>minus</i> their shoes and socks — were found lying on the beach at Ramlet al-Baida by the Beirut station manager of British Airways. [BNC ANU 1671]
152.	<i>versus</i>	Really it's a case of head <i>versus</i> heart. [BNC A15 1262]
153.	<i>per</i>	This works out at the equivalent of just £10 <i>per</i> day. [BNC A01 211]
154.	<i>gone</i> (BrE)	It's <i>gone</i> midnight. [BNC CAE 828]
155.	<i>since</i> (temporal)	About one-third of pupils have traditionally attended them <i>since</i> that time. [BNC A07 1347]
156.	<i>since</i> (non-temporal)	*
157.	<i>as</i> (temporal)	*
158.	<i>as</i> (causative)	*
159.	<i>on</i> (locative)	As there is no Embassy of Taiwan in the UK, please do not copy any appeals to another embassy, as proposed <i>on</i> the letter writing page. [BNC A03 158]
160.	<i>on</i> (concerning)	Despite the publicity <i>on</i> transmission of the disease, ignorance was such that they became afraid to even visit me. [BNC A02 95]
161.	<i>on</i> (non-locative)	*
162.	<i>off</i> (locative)	'Oh, she can't get <i>off</i> the island,' he said. [BNC A0D 386]
163.	<i>off</i> (non-locative)	*
164.	<i>outside</i> (locative)	<i>Outside</i> the church the statistics are higher still. [BNC A01 530]
165.	<i>outside</i> (exception)	*
166.	<i>in</i> (locative)	Cliff said, 'I am pleased to support ACET <i>in</i> the world they are doing. [BNC A00 118]
167.	<i>in</i> (non-locative)	Even if historians are specifically interested <i>in</i> form, it is likely to be the history of forms ... [BNC A04 137]
168.	<i>that</i> (purposive)	*
169.	<i>that</i> (empty)	*
170.	<i>while</i> (temporal)	*
171.	<i>while</i> (concessive)	*
172.	<i>whilst</i> (temporal)	*
173.	<i>whilst</i> (concessive)	*
174.	<i>apart</i> (away)	*
175.	<i>aside</i> (away)	*
176.	<i>apart</i> (exception)	<i>Apart</i> this, basil was a modest and unpretentious person. [BNC EVH 1414]
177.	<i>aside</i> (exception)	This <i>aside</i> , the tour was a success every night. [BNC ART 1537]
178.	<i>by</i> (non-locative)	The majority position among scholars on this topic, exemplified <i>by</i> Stephen J. Schulhofer in his influential 1974 article Harm and Punishment [COCA, ACAD]
179.	<i>by</i> (locative)	Philip found him <i>by</i> the door into the yard. [BNC ABX 2179]
180.	<i>at</i>	<i>At</i> your local club or church why not put on an evening for young people? [BNC A00 59]
181.	<i>about</i> (locative)	She looked <i>about</i> the room, and then back at him. [BNC C8S 768]
182.	<i>about</i> (concerning)	To reduce the number of new HIV infections by giving young people the facts <i>about</i> AIDS. [BNC A00 419]
183.	<i>worth</i>	Because shooting your brain to bits isn't <i>worth</i> it. [BNC A01 108]
184.	<i>near</i>	It was <i>near</i> midnight. [BNC A0L 574]
185.	<i>close</i>	*
186.	<i>far</i>	*

Property 4: Adverbial complement

	The functional word	Adverbial comp
1.	<i>with</i>	*
2.	<i>for fear</i>	*
3.	<i>of</i>	*
4.	<i>in order</i>	*
5.	<i>on condition</i>	*
6.	<i>as to</i>	*
7.	<i>as for</i>	*
8.	<i>for all</i>	*
9.	<i>as soon as</i>	*
10.	<i>as long as</i>	*
11.	<i>in case</i>	*
12.	<i>in the event</i>	*
13.	<i>on the basis</i>	*
14.	<i>on the grounds</i>	*
15.	<i>to the effect</i>	*
16.	<i>all over</i>	*
17.	<i>in two minds</i>	*
18.	<i>here</i>	*
19.	<i>there</i>	*
20.	<i>now</i>	*
21.	<i>upstairs, downstairs</i>	*
22.	<i>uphill, downhill</i>	*
23.	<i>upstage, downstage</i>	*
24.	<i>upstream, downstream</i>	*
25.	<i>overseas, overboard, overhead, overland</i>	*
26.	<i>underfoot</i>	*
27.	<i>underground</i>	*
28.	<i>home</i>	*
29.	<i>outdoors, indoors</i>	*
30.	<i>back</i>	*
31.	<i>backward(s), forward(s), upward(s), downward(s), inward(s), outward(s), eastward(s), northward(s), southward(s), westward(s), eastward(s), leftward(s), rightward(s), homeward(s), skyward(s), heavenward(s), seaward(s)</i>	*
32.	<i>abroad</i>	*
33.	<i>adrift</i>	*
34.	<i>aloft</i>	*
35.	<i>aground</i>	*
36.	<i>ashore</i>	*
37.	<i>contrary</i>	*
38.	<i>counter</i>	*
39.	<i>exclusive</i>	*
40.	<i>pursuant</i>	*
41.	<i>subsequent</i>	*
42.	<i>previous</i>	*
43.	<i>preparatory</i>	*
44.	<i>preliminary</i>	*
45.	<i>prior</i>	*
46.	<i>adjacent</i>	*
47.	<i>unbeknown(st)</i>	*
48.	<i>further (reference)</i>	*
49.	<i>consequent</i>	*
50.	<i>due</i>	*
51.	<i>next</i>	*

	The functional word	Adverbial comp
52.	<i>away</i>	*
53.	<i>out</i>	*
54.	<i>abreast</i>	*
55.	<i>aboard</i>	*
56.	<i>down</i>	*



57.	<i>up</i>	*
58.	<i>over</i>	*
59.	<i>along</i>	*
60.	<i>ahead</i>	*
61.	<i>less</i> ('minus')	*
62.	<i>thanks</i>	*
63.	<i>owing</i>	*
64.	<i>according</i>	*
65.	<i>regarding</i>	*
66.	<i>from</i>	*
67.	<i>upon</i>	*
68.	<i>because</i>	*
69.	<i>although</i>	*
70.	<i>whereas</i>	*
71.	<i>via</i>	*
72.	<i>when</i>	*
73.	<i>where</i>	*
74.	<i>until</i>	<i>Until recently, male chefs have shut their kitchen doors ... [BNC A0C 1574]</i>
75.	<i>after</i>	*
76.	<i>before</i>	*
77.	<i>whether</i>	*
78.	<i>without</i>	*
79.	<i>ago</i>	*
80.	<i>into</i>	*
81.	<i>onto</i>	*
82.	<i>between</i>	*
83.	<i>amid</i>	*
84.	<i>among</i>	*
85.	<i>against</i>	*
86.	<i>beside</i>	*
87.	<i>during</i>	*
88.	<i>come</i>	*
89.	<i>absent</i>	*
90.	<i>counting</i>	*
91.	<i>touching</i>	*
92.	<i>respecting</i>	*
93.	<i>concerning</i>	*
94.	<i>considering</i>	*
95.	<i>following</i>	*
96.	<i>failing</i>	*
97.	<i>barring</i>	*
98.	<i>excluding</i>	*
99.	<i>including</i>	*
100.	<i>pending</i>	*
101.	<i>excepting</i>	*
102.	<i>turning</i>	*
103.	<i>pertaining</i>	*
104.	<i>bearing</i>	*
105.	<i>having</i>	*
106.	<i>given</i>	*
107.	<i>granted</i>	*
108.	<i>provided</i>	*
109.	<i>providing</i>	*
110.	<i>supposing</i>	*
111.	<i>assuming</i>	*
112.	<i>seeing</i>	*
113.	<i>allowing</i>	*
114.	<i>bar</i>	*
115.	<i>except</i>	*
116.	<i>if</i>	*
117.	<i>regardless</i>	*
118.	<i>besides</i>	*
119.	<i>irrespective</i>	*
120.	<i>apropos</i>	*



	The functional word	Adverbial comp
121.	<i>but</i>	*
122.	<i>albeit</i>	... and was viewed as another sign that the economy is growing, albeit <i>slowly</i> . [BNC AL2 83]
123.	<i>notwithstanding</i>	*
124.	<i>though</i>	*
125.	<i>whenever</i>	*
126.	<i>wherever</i>	*
127.	<i>once</i> (temporal)	*
128.	<i>once</i> (TIMES)	*
129.	<i>unless</i>	*
130.	<i>lest</i>	*
131.	<i>whereupon</i>	*
132.	<i>opposite</i>	*
133.	<i>beyond</i>	*
134.	<i>past</i>	*
135.	<i>below</i>	*
136.	<i>above</i>	*
137.	<i>round</i>	*
138.	<i>underneath</i>	*
139.	<i>beneath</i>	*
140.	<i>around</i>	*
141.	<i>throughout</i>	*
142.	<i>through</i>	*
143.	<i>within</i>	*
144.	<i>across</i>	*
145.	<i>inside</i>	*
146.	<i>behind</i>	*
147.	<i>alongside</i>	*
148.	<i>under</i>	*
149.	N.S.E.W.	*
150.	<i>instead</i>	*
151.	<i>minus</i>	*
152.	<i>versus</i>	*
153.	<i>per</i>	*
154.	<i>gone</i> (BrE)	*
155.	<i>since</i> (temporal)	I've done more normal jobs <i>since</i> then. [BNC A0F 1573]
156.	<i>since</i> (non-temporal)	*
157.	<i>as</i> (temporal)	*
158.	<i>as</i> (causative)	*
159.	<i>on</i> (locative)	*
160.	<i>on</i> (concerning)	*
161.	<i>on</i> (non-locative)	*
162.	<i>off</i> (locative)	*
163.	<i>off</i> (non-locative)	*
164.	<i>outside</i> (locative)	*
165.	<i>outside</i> (exception)	*
166.	<i>in</i> (locative)	*
167.	<i>in</i> (non-locative)	*
168.	<i>that</i> (purposive)	*
169.	<i>that</i> (empty)	*
170.	<i>while</i> (temporal)	*
171.	<i>while</i> (concessive)	*
172.	<i>whilst</i> (temporal)	*
173.	<i>whilst</i> (concessive)	*
174.	<i>apart</i> ('away')	*
175.	<i>aside</i> ('away')	*
176.	<i>apart</i> (exception)	*
177.	<i>aside</i> (exception)	*
178.	<i>by</i> (non-locative)	*
179.	<i>by</i> (locative)	*
180.	<i>at</i>	*
181.	<i>about</i> (locative)	*
182.	<i>about</i> (concerning)	*
183.	<i>worth</i>	We're <i>worth</i> so much more. [BNC A0L 1204]
184.	<i>near</i>	*
185.	<i>close</i>	*
186.	<i>far</i>	*



Property 5: That-clause complement

	The functional word	That-clause comp
1.	<i>with</i>	*
2.	<i>for fear</i>	We couldn't have gone in daylight <i>for fear that</i> Dad would be spotted and reported to the relief officers; then as now claimants were not allowed to earn money. [BNC CDM 2241]
3.	<i>of</i>	*
4.	<i>in order</i>	Assumptions and expectations which lie behind an inter-agency approach require to be made more explicit <i>in order</i> that agencies, and individuals within agencies, are absolutely clear about where they stand, not only in relation to the paramount concern of protecting the child, but also in relation to each other. [BNC ALK 501]
5.	<i>on condition</i>	He added that this was <i>on condition</i> that he would withdraw claims for defamation of character made against the IJF ... [BNC A40 667]
6.	<i>as to</i>	*
7.	<i>as for</i>	*
8.	<i>for all</i>	<i>For all</i> that England are the only European nation not to concede a goal in the qualifying tournament, it is no exaggeration to suggest they have never been so ill-equipped for the persistent rigours of a World Cup. [BNC ASU 43]
9.	<i>as soon as</i>	*
10.	<i>as long as</i>	*
11.	<i>in case</i>	*
12.	<i>in the event</i>	<i>In the event</i> that the annual value figure cannot be agreed between the parties under s 837(3), it is to be determined by the General Commissioners. [BNC CBU 2656]
13.	<i>on the basis</i>	<i>On the basis</i> that it had continued thus, the blade would have had a total length of about five inches. [BNC ANL 1358]
14.	<i>on the grounds</i>	... the idea <i>on the grounds</i> that it would drive a wedge between clergy and people ... [BNC A07 698]
15.	<i>to the effect</i>	I wrote <i>to the effect</i> that I did indeed look forward to life with him, and that my guidelines for living were the same as his. [BNC AMC 683]
16.	<i>all over</i>	*
17.	<i>in two minds</i>	*
18.	<i>here</i>	*
19.	<i>there</i>	*
20.	<i>now</i>	... <i>now</i> that I am at last working on the big glass and have set up the two panels and locked them into their metal frame, notions like success and failure are no longer pertinent ... [BNC A08 111]
21.	<i>upstairs, downstairs</i>	*
22.	<i>uphill, downhill</i>	*
23.	<i>upstage, downstage</i>	*
24.	<i>upstream, downstream</i>	*
25.	<i>overseas, overboard, overhead, overland</i>	*
26.	<i>underfoot</i>	*
27.	<i>underground</i>	*
28.	<i>home</i>	*
29.	<i>outdoors, indoors</i>	*
30.	<i>back</i>	*
31.	<i>backward(s), forward(s), upward(s), downward(s), inward(s), outward(s), eastward(s), northward(s), southward(s), westward(s), eastward(s), leftward(s), rightward(s), homeward(s), skyward(s), heavenward(s), seaward(s)</i>	*
32.	<i>abroad</i>	*
33.	<i>adrift</i>	*



	The functional word	That-clause comp
34.	<i>aloft</i>	*
35.	<i>aground</i>	*
36.	<i>ashore</i>	*
37.	<i>contrary</i>	*
38.	<i>counter</i>	*
39.	<i>exclusive</i>	*
40.	<i>pursuant</i>	*
41.	<i>subsequent</i>	*
42.	<i>previous</i>	*
43.	<i>preparatory</i>	*
44.	<i>preliminary</i>	*
45.	<i>prior</i>	*
46.	<i>adjacent</i>	*
47.	<i>unbeknown(st)</i>	*
48.	<i>further</i> (reference)	*
49.	<i>consequent</i>	*
50.	<i>due</i>	*
51.	<i>next</i>	*
52.	<i>away</i>	*
53.	<i>out</i>	*
54.	<i>abreast</i>	*
55.	<i>aboard</i>	*
56.	<i>down</i>	*
57.	<i>up</i>	*
58.	<i>over</i>	*
59.	<i>along</i>	*
60.	<i>ahead</i>	*
61.	<i>less</i> ('minus')	*
62.	<i>thanks</i>	*
63.	<i>owing</i>	*
64.	<i>according</i>	*
65.	<i>regarding</i>	*
66.	<i>from</i>	*
67.	<i>upon</i>	*
68.	<i>because</i>	*
69.	<i>although</i>	*
70.	<i>whereas</i>	*
71.	<i>via</i>	*
72.	<i>when</i>	*
73.	<i>where</i>	*
74.	<i>until</i>	*
75.	<i>after</i>	*
76.	<i>before</i>	*
77.	<i>whether</i>	*
78.	<i>without</i>	*
79.	<i>ago</i>	*
80.	<i>into</i>	*
81.	<i>onto</i>	*
82.	<i>between</i>	*
83.	<i>amid</i>	*
84.	<i>among</i>	*
85.	<i>against</i>	*
86.	<i>beside</i>	*
87.	<i>during</i>	*
88.	<i>come</i>	*
89.	<i>absent</i>	*
90.	<i>counting</i>	*
91.	<i>touching</i>	*
92.	<i>respecting</i>	*
93.	<i>concerning</i>	*
94.	<i>considering</i>	<i>Considering that</i> this was written at a time when Pound's reputation was eclipsed ...[BNC A1B 623]
95.	<i>following</i>	*
96.	<i>failing</i>	*
97.	<i>barring</i>	*
98.	<i>excluding</i>	*
99.	<i>including</i>	*
100.	<i>pending</i>	*



	The functional word	That-clause comp
101.	<i>excepting</i>	He kept quiet, <i>excepting that</i> his look changed from friendliness to seriousness. [BNC HH3 6230]
102.	<i>turning</i>	*
103.	<i>pertaining</i>	*
104.	<i>bearing</i>	*
105.	<i>having</i>	*
106.	<i>given</i>	In particular, <i>given that</i> prices have already been set and cannot be changed, what will happen to real output? [BNC H9M 1101]
107.	<i>granted</i>	<i>Granted that</i> there is an absolute need for humanistic values to prevail in a neo-utilitarian and materialistic age, one is faced with a significant divergence in the nature of these values. [BNC A1A 1264]
108.	<i>provided</i>	<i>Provided that</i> the pilot keeps to the correct procedures, winch and car launches can be very safe. [BNC A0H 568]
109.	<i>providing</i>	Grilled beef can take any style <i>providing that</i> it's not too sweet (as German mustards are) or flavoured with an unsuitable herb such as dill. [BNC A0C 1453]
110.	<i>supposing</i>	<i>Supposing that</i> we did turn away from the cheap arguments, where could we find a better way? [BNC A5A 126]
111.	<i>assuming</i>	I believe that in Britain an outstanding record will find its way into the system without much promotion, <i>assuming that</i> it has been distributed to producers. [BNC A6A 1604]
112.	<i>seeing</i>	But, <i>seeing that</i> a fine picture is nature reflected by an artist, the criticism which I approve will be that picture reflected by an intelligent and sensitive mind. [BNC A04 217]
113.	<i>allowing</i>	<i>Allowing that</i> the countryside is the locus of virtue, Leapor makes sweeping though defensible observations on the attitudes of the rich and the power of money. [BNC AN4 3233]
114.	<i>bar</i>	*
115.	<i>except</i>	I don't know the name or address <i>except that</i> it is a club of some sort. [BNC A6V 318]
116.	<i>if</i>	*
117.	<i>regardless</i>	*
118.	<i>besides</i>	*
119.	<i>irrespective</i>	*
120.	<i>apropos</i>	*
121.	<i>but</i>	... that man is 'a finite piece of reasonable misery', in the words of William Drummond of Hawthornden, a good poet who was also a great plagiarist, and a great seeker of shelter in books — <i>but that</i> an eternal order might be felt for, or invented. [BNC A05 554]
122.	<i>albeit</i>	The conversion of one kind of cocaine to another was production of a substance 'by other means' <i>albeit that</i> the same generic term, cocaine, covered both substances. [BNC FBK 822]
123.	<i>notwithstanding</i>	This was <i>notwithstanding that</i> he had not found the relationship between the bank and the husband to be one of principal and agent. [BNC FD3 645]
124.	<i>though</i>	*
125.	<i>whenever</i>	*
126.	<i>wherever</i>	*
127.	<i>once</i> (temporal)	*
128.	<i>once</i> (TIMES)	*
129.	<i>unless</i>	*
130.	<i>lest</i>	*
131.	<i>whereupon</i>	*
132.	<i>opposite</i>	*
133.	<i>beyond</i>	*
134.	<i>past</i>	*
135.	<i>below</i>	*
136.	<i>above</i>	*
137.	<i>round</i>	*
138.	<i>underneath</i>	*
139.	<i>beneath</i>	*
140.	<i>around</i>	*
141.	<i>throughout</i>	*
142.	<i>through</i>	*
143.	<i>within</i>	*
144.	<i>across</i>	*
145.	<i>inside</i>	*
146.	<i>behind</i>	*
147.	<i>alongside</i>	*
148.	<i>under</i>	*
149.	N.S.E.W.	*
150.	<i>instead</i>	*
151.	<i>minus</i>	*
152.	<i>versus</i>	*
153.	<i>per</i>	*
154.	<i>gone</i> (BrE)	*
155.	<i>since</i> (temporal)	*



	The functional word	That-clause comp
156.	since (non-temporal)	*
157.	as (temporal)	*
158.	as (causative)	*
159.	on (locative)	*
160.	on (concerning)	*
161.	on (non-locative)	*
162.	off (locative)	*
163.	off (non-locative)	*
164.	outside (locative)	*
165.	outside (exception)	*
166.	in (locative)	*
167.	in (non-locative)	There is a further constraint <i>in</i> that the Ministry of Defence will keep a watchful eye on any potential partner or owner. [BNC A1S 194]
168.	that (purposive)	*
169.	that (empty)	*
170.	while (temporal)	*
171.	while (concessive)	*
172.	whilst (temporal)	*
173.	whilst (concessive)	*
174.	apart (away)	*
175.	aside (away)	*
176.	apart (exception)	*
177.	aside (exception)	*
178.	by (non-locative)	*
179.	by (locative)	*
180.	at	*
181.	about (locative)	*
182.	about (concerning)	*
183.	worth	*
184.	near	*
185.	close	*
186.	far	*

Property 6: That-less complement

	The functional word	That-less clause comp
1.	<i>with</i>	*
2.	<i>for fear</i>	Many of the PAN's traditional supporters appeared to abandon the party to support Salinas <i>for fear</i> the left might win. [BNC A1W 52]
3.	<i>of</i>	*
4.	<i>in order</i> ¹⁰	I feel Amnesty has to provide a quiet, more balanced overview of a region <i>in order</i> to maintain its impartiality and credibility, and to operate effectively. [BNC A03 1015]
5.	<i>on condition</i>	He consented to continue in office only <i>on condition</i> the Tsar suspended both chambers, disciplined his leading opponents in the State Council, and promulgated the bill under Article 87. [BNC FB1 193]
6.	<i>as to</i>	<i>As to whether</i> the defendant's claim was barred by section 10 of the Limitation Act 1980, the defendant's right to claim contribution accrued on the date when the plaintiff was given judgment: 6 February 1986. [BNC A50 29]
7.	<i>as for</i>	*
8.	<i>for all</i>	The copper anklet was probably the only thing of value she had possessed, and it was curious that it had not been stolen, <i>for all metal</i> was valuable in the Black Land. [BNC H84 2341]
9.	<i>as soon as</i>	Then <i>as soon as</i> the last act goes up Bobby will ring for a doctor and say that Bunty's had an accident. [BNC A0D 1475]
10.	<i>as long as</i>	<i>As long as</i> her money held out and she didn't open her mouth, she could almost make the artificial history stick. [BNC A0U 2301]
11.	<i>in case</i>	Electoral reform cannot be held in reserve <i>in case</i> things go wrong. [BNC A30 215]
12.	<i>in the event</i>	The Kilns venture was highly unusual, and the Lewis brothers knew that they could afford it by taking the great risk of throwing in their lot together, <i>in the event</i> the purchase price was lowered to £3,300. [BNC A7C 556]
13.	<i>on the basis</i>	Will you let me go again <i>on the basis</i> I made a cock-up the first time round. [BNC G4X 1136]
14.	<i>on the grounds</i>	Sir: I refer to the dropping of charges against the man accused of raping a mentally handicapped girl <i>on the grounds</i> she was not of fit mind to answer questions and give evidence (4 October). [BNC A44 132]
15.	<i>to the effect</i>	signed forms of authority giving access to her medical records, with a proviso <i>to the effect</i> there should be no copying, in any way, of her records, and that consent was only in respect of information 'relevant to my claim'. [BNC HB3 322]
16.	<i>all over</i>	*
17.	<i>in two minds</i>	*
18.	<i>here</i>	*
19.	<i>there</i>	*
20.	<i>now</i>	However, when no real progress is made, the time comes for reassessment, and it seems to me that that time is <i>now</i> . [BNC HHX 11310]
21.	<i>upstairs, downstairs</i>	*
22.	<i>uphill, downhill</i>	*
23.	<i>upstage, downstage</i>	*
24.	<i>upstream, downstream</i>	*
25.	<i>overseas, overboard, overhead, overland</i>	*
26.	<i>underfoot</i>	*
27.	<i>underground</i>	*
28.	<i>home</i>	*
29.	<i>outdoors, indoors</i>	*
30.	<i>back</i>	*
31.	<i>backward(s), forward(s), upward(s), downward(s), inward(s), outward(s), eastward(s), northward(s), southward(s), westward(s), eastward(s), leftward(s), rightward(s), homeward(s), skyward(s), heavenward(s), seaward(s)</i>	*
32.	<i>abroad</i>	*
33.	<i>adrift</i>	*
34.	<i>aloft</i>	*

¹⁰ There is another property of *in order* which is goes beyond the scope of the properties investigated in this study, namely infinitival *for*-clausal complement, as in *However, in order for the abdominals to grow you must treat them like any other muscle group, and work them hard for 8 to 12 reps using 3 to 4 sets* [BNC A0W 520].



	The functional word	That-less clause comp
35.	<i>aground</i>	*
36.	<i>ashore</i>	*
37.	<i>contrary</i>	*
38.	<i>counter</i>	*
39.	<i>exclusive</i>	*
40.	<i>pursuant</i>	*
41.	<i>subsequent</i>	*
42.	<i>previous</i>	*
43.	<i>preparatory</i>	*
44.	<i>preliminary</i>	*
45.	<i>prior</i>	*
46.	<i>adjacent</i>	*
47.	<i>unbeknown(st)</i>	*
48.	<i>further</i> (reference)	*
49.	<i>consequent</i>	*
50.	<i>due</i>	*
51.	<i>next</i>	*
52.	<i>away</i>	*
53.	<i>out</i>	*
54.	<i>abreast</i>	*
55.	<i>aboard</i>	*
56.	<i>down</i>	*
57.	<i>up</i>	*
58.	<i>over</i>	*
59.	<i>along</i>	*
60.	<i>ahead</i>	*
61.	<i>less</i> ('minus')	*
62.	<i>thanks</i>	*
63.	<i>owing</i>	*
64.	<i>according</i>	*
65.	<i>regarding</i>	*
66.	<i>from</i>	*
67.	<i>upon</i>	*
68.	<i>because</i>	You can also find it hard to remember things, <i>because</i> germs are multiplying in your brain. [BNC A01 16]
69.	<i>although</i>	<i>Although</i> an agent may be very impressed by the talent he sees, there are practical difficulties [BNC A06 1474]
70.	<i>whereas</i>	They are a reality, <i>whereas</i> the guerrillas are only a dream ... [BNC A05 51]
71.	<i>via</i>	*
72.	<i>when</i>	<i>When</i> people are fleeing from fear of imprisonment, torture or death, they will use any means available to reach a safe country. [BNC A03 947]
73.	<i>where</i>	This is not true in Philadelphia, <i>where</i> a new city decisively overwhelms the old. [BNC A04 523]
74.	<i>until</i>	Wait <i>until</i> first flowers have set fruit before planting out the peppers. [BNC A0G 1343]
75.	<i>after</i>	<i>After</i> every client visit you are asked to call the office [BNC A00 106]
76.	<i>before</i>	Owen, seven years younger, was killed one week <i>before</i> the war ended. [BNC A06 1136]
77.	<i>whether</i>	But <i>whether</i> the statement is rhetoric or reality, particularly for Mr Charles Haughey and [BNC A07 1062]
78.	<i>without</i>	She will not get marries <i>without</i> her father provides his blessing. [Google Web]
79.	<i>ago</i>	*
80.	<i>into</i>	*
81.	<i>onto</i>	*
82.	<i>between</i>	*
83.	<i>amid</i>	*
84.	<i>among</i>	*
85.	<i>against</i>	*
86.	<i>beside</i>	*
87.	<i>during</i>	*
88.	<i>come</i>	*
89.	<i>absent</i>	*
90.	<i>counting</i>	*
91.	<i>touching</i>	*
92.	<i>respecting</i>	*
93.	<i>concerning</i>	*
94.	<i>considering</i>	Ironically, <i>considering</i> they bought mainly by people who don't need to ask the price, Armani considers that the selling point of his signature clothes is that you can wear them forever. [ABNC A7P 211]
95.	<i>following</i>	*
96.	<i>failing</i>	*
97.	<i>barring</i>	*



	The functional word	That-less clause comp
98.	<i>excluding</i>	*
99.	<i>including</i>	*
100.	<i>pending</i>	*
101.	<i>excepting</i>	
102.	<i>turning</i>	*
103.	<i>pertaining</i>	*
104.	<i>bearing</i>	*
105.	<i>having</i>	*
106.	<i>given</i>	<i>Given</i> what has happened in Britain, certain enterprises could lend themselves to being sold to the Polish public who, surprisingly, might have few difficulties putting up hard cash to buy shares. [BNC AAJ 262]
107.	<i>granted</i>	<i>Granted</i> some of the images are a little sanitised, but the good intentions can be clearly read through the window dressing. [BNC APK 175]
108.	<i>provided</i>	<i>Provided</i> the gift is at least £600 it will be regarded as having been paid net of basic rate tax. [BNC A01 322]
109.	<i>providing</i>	<i>Providing</i> his French colleagues agree, which is akin to the BBC agreeing to retain Dan Maskell, he will stand for another four-year term as President of the French Federation, which will take him through to early 1997. [BNC A0V 220]
110.	<i>supposing</i>	<i>Supposing</i> the tramp was there behind the clump, she thought, smoking his pipe and waiting to catch her? [BNC B0B 2279]
111.	<i>assuming</i>	<i>Assuming</i> the manual is in comprehensible English, users can avoid many unnecessary calls to the help desk by a combination of consulting its index, and using the onscreen help built into the software. [BNC A0C 630]
112.	<i>seeing</i>	The master said: If there are no leaves for the beauties of Khvarism, yet Khyvarism must have its lovers, <i>seeing</i> there are countless beauties in that land. [BNC B1F 187]
113.	<i>allowing</i>	*
114.	<i>bar</i>	*
115.	<i>except</i>	I wouldn't get married at all <i>except</i> I need to work over there. [BNC A0U 468]
116.	<i>if</i>	I am asked if I can be on standby <i>if</i> transport is needed? [BNC A00 378]
117.	<i>regardless</i>	*
118.	<i>besides</i>	*
119.	<i>irrespective</i>	*
120.	<i>apropos</i>	*
121.	<i>but</i>	It never rains <i>but</i> it pours (Huddleston & Pullum, 2002: 971)
122.	<i>albeit</i>	Friday was bright <i>albeit</i> the wind was somewhat stronger and it was colder. [BNC GXA 975]
123.	<i>notwithstanding</i>	For its parts, a Bill of Rights insists that certain rights, privileges, and liberties are basic and must be afforded to all individuals <i>notwithstanding</i> what transient governments <i>might</i> wish to do. [BNC G3L 1071]
124.	<i>though</i>	Raphael's materials are generally borrowed, <i>though</i> the noble structure is his own. [BNC A04 335]
125.	<i>whenever</i>	The routine sheets should be filled in each week or <i>whenever</i> the weight is increased. [BNC A0W 481]
126.	<i>wherever</i>	<i>Wherever</i> there was a gig or a support, we took anything for Del Amitri. [BNC A6A 910]
127.	<i>once</i> (temporal)	<i>Once</i> flowers are over, cut the faded stems back to ground level. [BNC A0G 466]
128.	<i>once</i> (TIMES)	*
129.	<i>unless</i>	<i>Unless</i> the glider is going to be launched without delay, it should be turned out of wind and held with the into-wind wing down until it is needed. [BNC A0H 170]
130.	<i>lest</i>	I was self-conscious about my body to a painful degree, and terrified <i>lest</i> the weight came back. [BNC ADG 1577]
131.	<i>whereupon</i>	Then we were orientated towards the front of the room <i>whereupon</i> further orientation took place. [BNC BMF 238]
132.	<i>opposite</i>	*
133.	<i>beyond</i>	*
134.	<i>past</i>	*
135.	<i>below</i>	*
136.	<i>above</i>	*
137.	<i>round</i>	*
138.	<i>underneath</i>	*
139.	<i>beneath</i>	*
140.	<i>around</i>	*
141.	<i>throughout</i>	*
142.	<i>through</i>	*
143.	<i>within</i>	*
144.	<i>across</i>	*
145.	<i>inside</i>	*
146.	<i>behind</i>	*
147.	<i>alongside</i>	*
148.	<i>under</i>	*
149.	N.S.E.W.	*
150.	<i>instead</i>	*
151.	<i>minus</i>	*



	The functional word	That-less clause comp
152.	<i>versus</i>	*
153.	<i>per</i>	*
154.	<i>gone</i> (BrE)	*
155.	<i>since</i> (temporal)	The rapid growth of ACET <i>since</i> its inception in 1988 has made the creation of this new post a priority. [BNC A00 294]
156.	<i>since</i> (non-temporal)	<i>Since</i> black people in the southern states have suffered more injustices at the hands of the law they tend to be less likely to hand out death sentences. [BNC A03 718]
157.	<i>as</i> (temporal)	An ACET-link will play a vital role <i>as</i> our work is growing so rapidly. [BNC A00 175]
158.	<i>as</i> (causative)	<u>As</u> there is no Embassy of Taiwan in the UK, please do not copy any appeals to another embassy, as proposed on the letter writing page. [BNC A03 158]
159.	<i>on</i> (locative)	*
160.	<i>on</i> (concerning)	*
161.	<i>on</i> (non-locative)	*
162.	<i>off</i> (locative)	*
163.	<i>off</i> (non-locative)	*
164.	<i>outside</i> (locative)	*
165.	<i>outside</i> (exception)	*
166.	<i>in</i> (locative)	*
167.	<i>in</i> (non-locative)	*
168.	<i>that</i> (purposive)	They quickly offer their apologies, <i>that</i> they don't ruin their career. [Google Web]
169.	<i>that</i> (empty)	ACET volunteers work as part of a team and provide help in many different ways to ensure <i>that</i> people don't spend time in hospital unnecessarily. [BNC A00 82]
170.	<i>while</i> (temporal)	<i>While</i> over 2,300 people wait on death rows countrywide to see if they will die or not, we can only hope that the US comes to its senses soon. [BNCA03 749]
171.	<i>while</i> (concessive)	<i>While</i> numbers of new AIDS cases reported officially each month have remained relatively steady, there has been a big increase in those needing expert medical and nursing advice at home with a 24-hour on call back up. [BNC A00 269]
172.	<i>whilst</i> (temporal)	<i>Whilst</i> owing his debt to Lorca, it has to be said that this volume is markedly conservative. [BNC A0P 1461]
173.	<i>whilst</i> (concessive)	<i>Whilst</i> the age of the theme pub may be over, more and more old pubs are being transformed into identical, pseudo-historical clones. [BNC A0B 75]
174.	<i>apart</i> ('away')	*
175.	<i>aside</i> ('away')	*
176.	<i>apart</i> (exception)	*
177.	<i>aside</i> (exception)	*
178.	<i>by</i> (non-locative)	*
179.	<i>by</i> (locative)	*
180.	<i>at</i>	*
181.	<i>about</i> (locative)	*
182.	<i>about</i> (concerning)	*
183.	<i>worth</i>	*
184.	<i>near</i>	*
185.	<i>close</i>	*
186.	<i>far</i>	*

Property 7: Topicalisation

	The functional word	Topicalisation
1.	<i>with</i>	*
2.	<i>for fear</i>	I was never allowed to do anything <i>for fear</i> that my hands, it might spoil.
3.	<i>of</i>	*
4.	<i>in order</i> ¹¹	He did everything <i>in order</i> that this pizza he would get. [Q]
5.	<i>on condition</i>	They spoke <i>on condition</i> that their names he would use in his article. [Q]
6.	<i>as to</i>	*
7.	<i>as for</i>	*
8.	<i>for all</i>	<i>For all</i> that the solution he understands, John cannot solve the problem. [Q]
9.	<i>as soon as</i>	<i>As soon as</i> John, I see, I will spread the word about the charity's work. (in the context where anyone else apart from John won't be accepted.) [Q]
10.	<i>as long as</i>	<i>As long as</i> cheese he eats, he never suffers from bone pain. (when it means provided) [Q]
11.	<i>in case</i>	<i>In case</i> that pizza, he might not eat, I prepared another pizza with some mozzarella cheese. [Q]
12.	<i>in the event</i>	<i>In the event</i> that this job he loses, he planned to start a business. [Q]
13.	<i>on the basis</i>	<i>On the basis</i> that this bill he receives, he will be contacted more regularly [Q]
14.	<i>on the grounds</i>	<i>On the grounds</i> that his passport he lost, it would be quite difficult for him cross the border. [Q]
15.	<i>to the effect</i>	Harry murmured something <i>to the effect</i> that Margret, they would all meet. [Q]
16.	<i>all over</i>	*
17.	<i>in two minds</i>	*
18.	<i>here</i>	*
19.	<i>there</i>	*
20.	<i>now</i>	*
21.	<i>upstairs, downstairs</i>	*
22.	<i>uphill, downhill</i>	*
23.	<i>upstage, downstage</i>	*
24.	<i>upstream, downstream</i>	*
25.	<i>overseas, overboard, overhead, overland</i>	*
26.	<i>underfoot</i>	*
27.	<i>underground</i>	*
28.	<i>home</i>	*
29.	<i>outdoors, indoors</i>	*
30.	<i>back</i>	*
31.	<i>backward(s), forward(s), upward(s), downward(s), inward(s), outward(s), eastward(s), northward(s), southward(s), westward(s), eastward(s), leftward(s), rightward(s), homeward(s), skyward(s), heavenward(s), seaward(s)</i>	*
32.	<i>abroad</i>	*
33.	<i>adrift</i>	*
34.	<i>aloft</i>	*
35.	<i>aground</i>	*
36.	<i>ashore</i>	*
37.	<i>contrary</i>	*
38.	<i>counter</i>	*
39.	<i>exclusive</i>	*
40.	<i>pursuant</i>	*
41.	<i>subsequent</i>	*
42.	<i>previous</i>	*
43.	<i>preparatory</i>	*
44.	<i>preliminary</i>	*
45.	<i>prior</i>	*
46.	<i>adjacent</i>	*
47.	<i>unknown(st)</i>	*
48.	<i>further</i> (reference)	*

¹¹ There is another property of *in order* which is goes beyond the scope of the properties investigated in this study, namely infinitival *for*-clausal complement, as in *Staff must be committed to the change in order for it to succeed.*



	The functional word	Topicalisation
49.	<i>consequent</i>	*
50.	<i>due</i>	*
51.	<i>next</i>	*
52.	<i>away</i>	*
53.	<i>out</i>	*
54.	<i>abreast</i>	*
55.	<i>aboard</i>	*
56.	<i>down</i>	*
57.	<i>up</i>	*
58.	<i>over</i>	*
59.	<i>along</i>	*
60.	<i>ahead</i>	*
61.	<i>less</i> ('minus')	*
62.	<i>thanks</i>	*
63.	<i>owing</i>	*
64.	<i>according</i>	*
65.	<i>regarding</i>	*
66.	<i>from</i>	*
67.	<i>upon</i>	*
68.	<i>because</i>	<i>Because</i> strict commands like these, he had to obey, he hated being in the army. [Q]
69.	<i>although</i>	<i>Although</i> the solution he understands, he cannot solve the problem. [Q]
70.	<i>whereas</i>	People say "fries" in America, <i>whereas</i> "chips" people call them in Britain. [Q]
71.	<i>via</i>	*
72.	<i>when</i>	<i>When</i> this solution, he understands, he will be able to solve the problem. [Q]
73.	<i>where</i>	<i>Where</i> that song he sings, everyone closes their eyes. [Q]
74.	<i>until</i>	<i>Until</i> this solution he understands, he can solve the problem. [Q]
75.	<i>after</i>	*
76.	<i>before</i>	*
77.	<i>whether</i>	<i>Whether</i> the truth he tells, more investigation is still needed. [Q]
78.	<i>without</i>	She will not get marries <i>without lots of blessings</i> , her father provides. [Q]
79.	<i>ago</i>	*
80.	<i>into</i>	*
81.	<i>onto</i>	*
82.	<i>between</i>	*
83.	<i>amid</i>	*
84.	<i>among</i>	*
85.	<i>against</i>	*
86.	<i>beside</i>	*
87.	<i>during</i>	*
88.	<i>come</i>	*
89.	<i>absent</i>	*
90.	<i>counting</i>	*
91.	<i>touching</i>	*
92.	<i>respecting</i>	*
93.	<i>concerning</i>	*
94.	<i>considering</i>	<i>Considering</i> that the solution he introduces, he is unable to see how it works. [Q]
95.	<i>following</i>	*
96.	<i>failing</i>	*
97.	<i>barring</i>	*
98.	<i>excluding</i>	*
99.	<i>including</i>	*
100.	<i>pending</i>	*
101.	<i>excepting</i>	If no organic being <i>excepting</i> man had possessed any mental power, or if his powers had been of a wholly different nature from those of the lower animals ... [BNC AMG 1166]
102.	<i>turning</i>	*
103.	<i>pertaining</i>	*
104.	<i>bearing</i>	*
105.	<i>having</i>	*
106.	<i>given</i>	<i>Given</i> that the solution he introduces, he is unable to see how it works. [Q]
107.	<i>granted</i>	<i>Granted</i> that decisions those officers have made, they still couldn't be expected to understand. [Q]
108.	<i>provided</i>	<i>Provided</i> that on time the boat leaves, we reach France by morning. [Q]
109.	<i>providing</i>	<i>Providing</i> that bad injuries, we avoid, we have the team who will win the league. [Q]
110.	<i>supposing</i>	<i>Supposing</i> that the answer he knows, he would ... [Q]
111.	<i>assuming</i>	<i>Assuming</i> that the answer he understands, he would ... [Q]
112.	<i>seeing</i>	<i>Seeing</i> that the answer he knows, he will enter the competition. [Q]
113.	<i>allowing</i>	<i>Allowing</i> that this van he can drive, they can get the goods to the south very easily. [Q]
114.	<i>bar</i>	*
115.	<i>except</i>	He hates his students, <i>except</i> Nancy he adores. [Q]



	The functional word	Topicalisation
116.	<i>if</i>	<i>If</i> the last bus we miss, we'll have to walk home.
117.	<i>regardless</i>	*
118.	<i>besides</i>	*
119.	<i>irrespective</i>	*
120.	<i>apropos</i>	*
121.	<i>but</i>	*
122.	<i>albeit</i>	<i>Albeit</i> the solution he understands, John cannot solve the problem. [Q]
123.	<i>notwithstanding</i>	<i>Notwithstanding</i> that the solution he understands, he cannot solve the problem. [Q]
124.	<i>though</i>	<i>Though</i> the solution he understands, he cannot solve the problem. [Q]
125.	<i>whenever</i>	<i>Whenever</i> that song, John sings, everyone leaves the hall. (whereas in other cases where he sings other songs, everyone keeps listening). [Q]
126.	<i>wherever</i>	<i>Wherever</i> that song, John sings, no one understands him. [Q]
127.	<i>once</i> (temporal)	<i>Once</i> his wife he sees, he starts complaining. [Q]
128.	<i>once</i> (TIMES)	*
129.	<i>unless</i>	<i>Unless</i> a lesson like this, the tutor includes, I won't do the exam. [Q]
130.	<i>lest</i>	He wears headphones now <i>lest</i> John, he might disturb. [Q]
131.	<i>whereupon</i>	I told her she looked fat, <i>whereupon</i> the entire contents of a saucepan, she threw at me. [Q]
132.	<i>opposite</i>	*
133.	<i>beyond</i>	*
134.	<i>past</i>	*
135.	<i>below</i>	*
136.	<i>above</i>	*
137.	<i>round</i>	*
138.	<i>underneath</i>	*
139.	<i>beneath</i>	*
140.	<i>around</i>	*
141.	<i>throughout</i>	*
142.	<i>through</i>	*
143.	<i>within</i>	*
144.	<i>across</i>	*
145.	<i>inside</i>	*
146.	<i>behind</i>	*
147.	<i>alongside</i>	*
148.	<i>under</i>	*
149.	N.S.E.W.	*
150.	<i>instead</i>	*
151.	<i>minus</i>	*
152.	<i>versus</i>	*
153.	<i>per</i>	*
154.	<i>gone</i> (BrE)	*
155.	<i>since</i> (temporal)	<i>Since</i> strict commands like these, he had to obey, he hated being in the army. [Q]
156.	<i>since</i> (non-temporal)	*
157.	<i>as</i> (temporal)	*
158.	<i>as</i> (causative)	<i>As</i> strict commands like these, he had to obey, he hated being in the army. [Q]
159.	<i>on</i> (locative)	*
160.	<i>on</i> (concerning)	*
161.	<i>on</i> (non-locative)	*
162.	<i>off</i> (locative)	*
163.	<i>off</i> (non-locative)	*
164.	<i>outside</i> (locative)	*
165.	<i>outside</i> (exception)	*
166.	<i>in</i> (locative)	*
167.	<i>in</i> (non-locative)	*
168.	<i>that</i> (purposive)	They quickly offer their apologies, <i>that</i> their career they don't ruin.
169.	<i>that</i> (empty)	<i>Notwithstanding that</i> the solution he understands, he cannot solve the problem. [Q]
170.	<i>while</i> (temporal)	<i>While</i> the solution he understands, he cannot solve the problem. [Q]
171.	<i>while</i> (concessive)	*
172.	<i>whilst</i> (temporal)	<i>Whilst</i> the solution he understands, he cannot solve the problem. [Q]
173.	<i>whilst</i> (concessive)	*
174.	<i>apart</i> ('away')	*
175.	<i>aside</i> ('away')	*
176.	<i>apart</i> (exception)	*
177.	<i>aside</i> (exception)	*
178.	<i>by</i> (non-locative)	*
179.	<i>by</i> (locative)	*
180.	<i>at</i>	*
181.	<i>about</i> (locative)	*
182.	<i>about</i> (concerning)	*



	The functional word	Topicalisation
183.	<i>worth</i>	*
184.	<i>near</i>	*
185.	<i>close</i>	*
186.	<i>far</i>	*



Property 8: Small clause comp: subject is overt and pred is verbal

	The functional word	Small clause comp: subject is overt and pred is verbal
1.	<i>with</i>	At the moment, <i>with</i> me sitting in my position, it is easy to say 'well, I'm not sure, I'm not going to begin the process of investigation here'. [BNC A30 193]
2.	<i>for fear</i>	*
3.	<i>of</i>	This sort of listing is worth knowing by a reader, who may occasionally notice that it underlies the degree <i>of</i> attention being paid to a theme by a critic. [BNC A04 665]
4.	<i>in order</i>	*
5.	<i>on condition</i>	*
6.	<i>as to</i>	*
7.	<i>as for</i>	*
8.	<i>for all</i>	*
9.	<i>as soon as</i>	*
10.	<i>as long as</i>	*
11.	<i>in case</i>	*
12.	<i>in the event</i>	*
13.	<i>on the basis</i>	*
14.	<i>on the grounds</i>	*
15.	<i>to the effect</i>	*
16.	<i>all over</i>	*
17.	<i>in two minds</i>	*
18.	<i>here</i>	*
19.	<i>there</i>	*
20.	<i>now</i>	*
21.	<i>upstairs, downstairs</i>	*
22.	<i>uphill, downhill</i>	*
23.	<i>upstage, downstage</i>	*
24.	<i>upstream, downstream</i>	*
25.	<i>overseas, overboard, overhead, overland</i>	*
26.	<i>underfoot</i>	*
27.	<i>underground</i>	*
28.	<i>home</i>	*
29.	<i>outdoors, indoors</i>	*
30.	<i>back</i>	*
31.	<i>backward(s), forward(s), upward(s), downwards(s), inward(s), outward(s), eastward(s), northward(s), southward(s), westward(s), eastward(s), leftward(s), rightward(s), homeward(s), skyward(s), heavenward(s), seaward(s)</i>	*
32.	<i>abroad</i>	*
33.	<i>adrift</i>	*
34.	<i>aloft</i>	*
35.	<i>aground</i>	*
36.	<i>ashore</i>	*
37.	<i>contrary</i>	*
38.	<i>counter</i>	*
39.	<i>exclusive</i>	*
40.	<i>pursuant</i>	*
41.	<i>subsequent</i>	*
42.	<i>previous</i>	*
43.	<i>preparatory</i>	*
44.	<i>preliminary</i>	*
45.	<i>prior</i>	*
46.	<i>adjacent</i>	*
47.	<i>unbeknown(st)</i>	*
48.	<i>further</i> (reference)	*
49.	<i>consequent</i>	*
50.	<i>due</i>	*
51.	<i>next</i>	*
52.	<i>away</i>	*
53.	<i>out</i>	*
54.	<i>abreast</i>	*
55.	<i>aboard</i>	*
56.	<i>down</i>	*



	The functional word	Small clause comp: subject is overt and pred is verbal
57.	<i>up</i>	*
58.	<i>over</i>	*
59.	<i>along</i>	*
60.	<i>ahead</i>	*
61.	<i>less</i> ('minus')	*
62.	<i>thanks</i>	*
63.	<i>owing</i>	*
64.	<i>according</i>	*
65.	<i>regarding</i>	*
66.	<i>from</i>	*
67.	<i>upon</i>	*
68.	<i>because</i>	*
69.	<i>although</i>	*
70.	<i>whereas</i>	*
71.	<i>via</i>	*
72.	<i>when</i>	*
73.	<i>where</i>	*
74.	<i>until</i>	*
75.	<i>after</i>	*
76.	<i>before</i>	*
77.	<i>whether</i>	*
78.	<i>without</i>	It was a Christian colleague in the English Faculty who said, 'The problem of pain is quite bad enough <i>without</i> Lewis making it worse.' [BNC A7C 1534]
79.	<i>ago</i>	*
80.	<i>into</i>	*
81.	<i>onto</i>	*
82.	<i>between</i>	*
83.	<i>amid</i>	*
84.	<i>among</i>	*
85.	<i>against</i>	*
86.	<i>beside</i>	*
87.	<i>during</i>	*
88.	<i>come</i>	*
89.	<i>absent</i>	*
90.	<i>counting</i>	*
91.	<i>touching</i>	*
92.	<i>respecting</i>	*
93.	<i>concerning</i>	But, what I was gonna say was [pause] <i>concerning</i> them blocking these pavements. [BNC KE6 10204]
94.	<i>considering</i>	*
95.	<i>following</i>	*
96.	<i>failing</i>	*
97.	<i>barring</i>	*
98.	<i>excluding</i>	*
99.	<i>including</i>	*
100.	<i>pending</i>	*
101.	<i>excepting</i>	*
102.	<i>turning</i>	*
103.	<i>pertaining</i>	*
104.	<i>bearing</i>	*
105.	<i>having</i>	*
106.	<i>given</i>	*
107.	<i>granted</i>	*
108.	<i>provided</i>	*
109.	<i>providing</i>	*
110.	<i>supposing</i>	*
111.	<i>assuming</i>	*
112.	<i>seeing</i>	*
113.	<i>allowing</i>	*
114.	<i>bar</i>	*
115.	<i>except</i>	*
116.	<i>if</i>	*
117.	<i>regardless</i>	*
118.	<i>besides</i>	*
119.	<i>irrespective</i>	*
120.	<i>apropos</i>	*
121.	<i>but</i>	*
122.	<i>albeit</i>	*
123.	<i>notwithstanding</i>	*



	The functional word	Small clause comp: subject is overt and pred is verbal
124.	<i>though</i>	*
125.	<i>whenever</i>	*
126.	<i>wherever</i>	*
127.	<i>once</i> (temporal)	*
128.	<i>once</i> (TIMES)	*
129.	<i>unless</i>	*
130.	<i>lest</i>	*
131.	<i>whereupon</i>	*
132.	<i>opposite</i>	*
133.	<i>beyond</i>	*
134.	<i>past</i>	*
135.	<i>below</i>	*
136.	<i>above</i>	*
137.	<i>round</i>	*
138.	<i>underneath</i>	*
139.	<i>beneath</i>	*
140.	<i>around</i>	*
141.	<i>throughout</i>	*
142.	<i>through</i>	*
143.	<i>within</i>	*
144.	<i>across</i>	*
145.	<i>inside</i>	*
146.	<i>behind</i>	*
147.	<i>alongside</i>	*
148.	<i>under</i>	*
149.	N.S.E.W.	*
150.	<i>instead</i>	*
151.	<i>minus</i>	*
152.	<i>versus</i>	*
153.	<i>per</i>	*
154.	<i>gone</i> (BrE)	*
155.	<i>since</i> (temporal)	*
156.	<i>since</i> (non-temporal)	*
157.	<i>as</i> (temporal)	*
158.	<i>as</i> (causative)	*
159.	<i>on</i> (locative)	*
160.	<i>on</i> (concerning)	*
161.	<i>on</i> (non-locative)	*
162.	<i>off</i> (locative)	*
163.	<i>off</i> (non-locative)	*
164.	<i>outside</i> (locative)	*
165.	<i>outside</i> (exception)	*
166.	<i>in</i> (locative)	*
167.	<i>in</i> (non-locative)	*
168.	<i>that</i> (purposive)	*
169.	<i>that</i> (empty)	*
170.	<i>while</i> (temporal)	*
171.	<i>while</i> (concessive)	*
172.	<i>whilst</i> (temporal)	*
173.	<i>whilst</i> (concessive)	*
174.	<i>apart</i> (away)	*
175.	<i>aside</i> (away)	*
176.	<i>apart</i> (exception)	*
177.	<i>aside</i> (exception)	*
178.	<i>by</i> (non-locative)	I can't, but we won't get anywhere <i>by</i> you being squeamish ... [BNC AD9 3797]
179.	<i>by</i> (locative)	*
180.	<i>at</i>	*
181.	<i>about</i> (locative)	*
182.	<i>about</i> (concerning)	*
183.	<i>worth</i>	*
184.	<i>near</i>	*
185.	<i>close</i>	*
186.	<i>far</i>	*



Property 9: Small clause comp: subject is overt and pred is non-verbal

	The functional word	Small clause comp: subject is overt and pred is non-verbal
1.	<i>with</i>	He drops the script and hops about <i>with</i> hands in his armpits, going 'Ouch!' [BNC A06 1033]
2.	<i>for fear</i>	*
3.	<i>of</i>	Really it's a case <i>of</i> head versus heart. [BNC A15 1262]
4.	<i>in order</i>	*
5.	<i>on condition</i>	*
6.	<i>as to</i>	*
7.	<i>as for</i>	*
8.	<i>for all</i>	*
9.	<i>as soon as</i>	*
10.	<i>as long as</i>	*
11.	<i>in case</i>	*
12.	<i>in the event</i>	*
13.	<i>on the basis</i>	*
14.	<i>on the grounds</i>	*
15.	<i>to the effect</i>	*
16.	<i>all over</i>	*
17.	<i>in two minds</i>	*
18.	<i>here</i>	*
19.	<i>there</i>	*
20.	<i>now</i>	*
21.	<i>upstairs, downstairs</i>	*
22.	<i>uphill, downhill</i>	*
23.	<i>upstage, downstage</i>	*
24.	<i>upstream, downstream</i>	*
25.	<i>overseas, overboard, overhead, overland</i>	*
26.	<i>underfoot</i>	*
27.	<i>underground</i>	*
28.	<i>home</i>	*
29.	<i>outdoors, indoors</i>	*
30.	<i>back</i>	*
31.	<i>backward(s), forward(s), upward(s), downward(s), inward(s), outward(s), eastward(s), northward(s), southward(s), westward(s), eastward(s), leftward(s), rightward(s), homeward(s), skyward(s), heavenward(s), seaward(s)</i>	*
32.	<i>abroad</i>	*
33.	<i>adrift</i>	*
34.	<i>aloft</i>	*
35.	<i>aground</i>	*
36.	<i>ashore</i>	*
37.	<i>contrary</i>	*
38.	<i>counter</i>	*
39.	<i>exclusive</i>	*
40.	<i>pursuant</i>	*
41.	<i>subsequent</i>	*
42.	<i>previous</i>	*
43.	<i>preparatory</i>	*
44.	<i>preliminary</i>	*
45.	<i>prior</i>	*
46.	<i>adjacent</i>	*
47.	<i>unbeknown(st)</i>	*
48.	<i>further</i> (reference)	*
49.	<i>consequent</i>	*
50.	<i>due</i>	*
51.	<i>next</i>	*
52.	<i>away</i>	*



	The functional word	Small clause comp: subject is overt and pred is non-verbal
53.	<i>out</i>	*
54.	<i>abreast</i>	*
55.	<i>aboard</i>	*
56.	<i>down</i>	*
57.	<i>up</i>	*
58.	<i>over</i>	*
59.	<i>along</i>	*
60.	<i>ahead</i>	*
61.	<i>less</i> ('minus')	*
62.	<i>thanks</i>	*
63.	<i>owing</i>	*
64.	<i>according</i>	*
65.	<i>regarding</i>	*
66.	<i>from</i>	*
67.	<i>upon</i>	*
68.	<i>because</i>	*
69.	<i>although</i>	*
70.	<i>whereas</i>	*
71.	<i>via</i>	*
72.	<i>when</i>	*
73.	<i>where</i>	*
74.	<i>until</i>	*
75.	<i>after</i>	*
76.	<i>before</i>	*
77.	<i>whether</i>	*
78.	<i>without</i>	What's going to happen to you <i>without</i> me behind you? [BNC CFY 907]
79.	<i>ago</i>	*
80.	<i>into</i>	*
81.	<i>onto</i>	*
82.	<i>between</i>	*
83.	<i>amid</i>	*
84.	<i>among</i>	*
85.	<i>against</i>	*
86.	<i>beside</i>	*
87.	<i>during</i>	*
88.	<i>come</i>	*
89.	<i>absent</i>	*
90.	<i>counting</i>	*
91.	<i>touching</i>	*
92.	<i>respecting</i>	*
93.	<i>concerning</i>	*
94.	<i>considering</i>	*
95.	<i>following</i>	*
96.	<i>failing</i>	*
97.	<i>barring</i>	*
98.	<i>excluding</i>	*
99.	<i>including</i>	*
100.	<i>pending</i>	*
101.	<i>excepting</i>	*
102.	<i>turning</i>	*
103.	<i>pertaining</i>	*
104.	<i>bearing</i>	*
105.	<i>having</i>	*
106.	<i>given</i>	*
107.	<i>granted</i>	*
108.	<i>provided</i>	*
109.	<i>providing</i>	*
110.	<i>supposing</i>	*
111.	<i>assuming</i>	*
112.	<i>seeing</i>	*
113.	<i>allowing</i>	*
114.	<i>bar</i>	*
115.	<i>except</i>	*
116.	<i>if</i>	*
117.	<i>regardless</i>	*
118.	<i>besides</i>	*
119.	<i>irrespective</i>	*
120.	<i>apropos</i>	*
121.	<i>but</i>	*
122.	<i>albeit</i>	*
123.	<i>notwithstanding</i>	*
124.	<i>though</i>	*



	The functional word	Small clause comp: subject is overt and pred is non-verbal
125.	<i>whenever</i>	*
126.	<i>wherever</i>	*
127.	<i>once</i> (temporal)	*
128.	<i>once</i> (TIMES)	*
129.	<i>unless</i>	*
130.	<i>lest</i>	*
131.	<i>whereupon</i>	*
132.	<i>opposite</i>	*
133.	<i>beyond</i>	*
134.	<i>past</i>	*
135.	<i>below</i>	*
136.	<i>above</i>	*
137.	<i>round</i>	*
138.	<i>underneath</i>	*
139.	<i>beneath</i>	*
140.	<i>around</i>	*
141.	<i>throughout</i>	*
142.	<i>through</i>	*
143.	<i>within</i>	*
144.	<i>across</i>	*
145.	<i>inside</i>	*
146.	<i>behind</i>	*
147.	<i>alongside</i>	*
148.	<i>under</i>	*
149.	N.S.E.W.	*
150.	<i>instead</i>	*
151.	<i>minus</i>	*
152.	<i>versus</i>	*
153.	<i>per</i>	*
154.	<i>gone</i> (BrE)	*
155.	<i>since</i> (temporal)	*
156.	<i>since</i> (non-temporal)	*
157.	<i>as</i> (temporal)	*
158.	<i>as</i> (causative)	*
159.	<i>on</i> (locative)	*
160.	<i>on</i> (concerning)	*
161.	<i>on</i> (non-locative)	*
162.	<i>off</i> (locative)	*
163.	<i>off</i> (non-locative)	*
164.	<i>outside</i> (locative)	*
165.	<i>outside</i> (exception)	*
166.	<i>in</i> (locative)	*
167.	<i>in</i> (non-locative)	*
168.	<i>that</i> (purposive)	*
169.	<i>that</i> (empty)	*
170.	<i>while</i> (temporal)	*
171.	<i>while</i> (concessive)	*
172.	<i>whilst</i> (temporal)	*
173.	<i>whilst</i> (concessive)	*
174.	<i>apart</i> (away)	*
175.	<i>aside</i> (away)	*
176.	<i>apart</i> (exception)	*
177.	<i>aside</i> (exception)	*
178.	<i>by</i> (non-locative)	*
179.	<i>by</i> (locative)	*
180.	<i>at</i>	*
181.	<i>about</i> (locative)	*
182.	<i>about</i> (concerning)	*
183.	<i>worth</i>	*
184.	<i>near</i>	*
185.	<i>close</i>	*
186.	<i>far</i>	*



Property 10: Small clause comp: subject of comp is raised and pred is verbal

	The functional word	Small clause comp: subject of comp is raised and pred is verbal
	<i>with</i>	They were charged <i>with having</i> formed a 'hostile' organization aimed at securing republic status for Kosovo province. [BNC A03 615]
1.	<i>for fear</i>	*
2.	<i>of</i>	At the time you enter a Deed of Covenant, the covenant should be capable <i>of</i> lasting for more than 3 years , and there should be the intention by you that it does so. [BNC A01 247]
3.	<i>in order</i>	*
4.	<i>on condition</i>	*
5.	<i>as to</i>	*
6.	<i>as for</i>	*
7.	<i>for all</i>	*
8.	<i>as soon as</i>	*
9.	<i>as long as</i>	*
10.	<i>in case</i>	*
11.	<i>in the event</i>	*
12.	<i>on the basis</i>	*
13.	<i>on the grounds</i>	*
14.	<i>to the effect</i>	*
15.	<i>all over</i>	*
16.	<i>in two minds</i>	*
17.	<i>here</i>	*
18.	<i>there</i>	*
19.	<i>now</i>	*
20.	<i>upstairs, downstairs</i>	*
21.	<i>uphill, downhill</i>	*
22.	<i>upstage, downstage</i>	*
23.	<i>upstream, downstream</i>	*
24.	<i>overseas, overboard, overhead, overland</i>	*
25.	<i>underfoot</i>	*
26.	<i>underground</i>	*
27.	<i>home</i>	*
28.	<i>outdoors, indoors</i>	*
29.	<i>back</i>	*
30.	<i>backward(s), forward(s), upward(s), downward(s), inward(s), outward(s), eastward(s), northward(s), southward(s), westward(s), eastward(s), leftward(s), rightward(s), homeward(s), skyward(s), heavenward(s), seaward(s)</i>	*
31.	<i>abroad</i>	*
32.	<i>adrift</i>	*
33.	<i>aloft</i>	*
34.	<i>aground</i>	*
35.	<i>ashore</i>	*
36.	<i>contrary</i>	*
37.	<i>counter</i>	*
38.	<i>exclusive</i>	*
39.	<i>pursuant</i>	*
40.	<i>subsequent</i>	*
41.	<i>previous</i>	*
42.	<i>preparatory</i>	*
43.	<i>preliminary</i>	*
44.	<i>prior</i>	*
45.	<i>prior to</i>	*
46.	<i>adjacent</i>	*
47.	<i>unknown(st)</i>	*
48.	<i>further</i> (reference)	*



	The functional word	Small clause comp: subject of comp is raised and pred is verbal
49.	<i>consequent</i>	*
50.	<i>due</i>	*
51.	<i>next</i>	*
52.	<i>away</i>	*
53.	<i>out</i>	*
54.	<i>abreast</i>	*
55.	<i>aboard</i>	*
56.	<i>down</i>	*
57.	<i>up</i>	*
58.	<i>over</i>	*
59.	<i>along</i>	*
60.	<i>ahead</i>	*
61.	<i>less</i> ('minus')	*
62.	<i>thanks</i>	*
63.	<i>owing</i>	*
64.	<i>according</i>	*
65.	<i>regarding</i>	He had learned his lesson <i>regarding</i> being prepared from the previous Friday night. [BNC B3J 2445]
66.	<i>from</i>	So, what can you learn <i>from</i> looking so closely at the actor on stage, TV and cinema? [BNC A06 19]
67.	<i>upon</i>	Charles had pushed himself to the limit in the armed forces and had insisted <i>upon</i> doing the full training that his fellow officers did — despite protests from his superiors. [BNC A7H 1057]
68.	<i>because</i>	*
69.	<i>although</i>	<i>Although</i> recognising that many such 'Go, No-Go' decisions are made after a brief examination by one or two executives, he argues that more 'scientific' or 'realistic' comparative methods of assessment should be used. [BNC A60 958]
70.	<i>whereas</i>	*
71.	<i>via</i>	An encouraging sign was the availability in 1990–91 of education support grant (covering 60 per cent of the cost of specific projects) for initiatives to improve school attendance, including the improvement of home — school liaison <i>via</i> extending the role of EWOs. [BNC AN5 366]
72.	<i>when</i>	<i>When</i> auditioning for most schools you will be asked to present at least two contrasting speeches and possibly give some idea of your attitude to improvisation and, perhaps, to singing. [BNC A06 220]
73.	<i>where</i>	Having marked the ripstop, stop to work out how much extra you will need to allow for the leading edge pocket, or any hems, either on unsupported edges or <i>where</i> joining to another panel. [BNC CA1 426]
74.	<i>until</i>	JAMES Kerr-Muir, managing director of Tate & Lyle's British operations <i>until</i> leaving last November, has been appointed finance director at Kingfisher, the Woolworths and B & Q retailer. [BNC AJP 113]
75.	<i>after</i>	They all 'disappeared' <i>after</i> being taken into custody by members of the Indian Peace Keeping Force. [BNC A03 413]
76.	<i>before</i>	Three visitors from Frankfurt, Germany, recently visited ACET's offices <i>before</i> returning home to begin a similar service, Christian AIDS Help (CAH). [BNC A00 159]
77.	<i>whether</i>	*
78.	<i>without</i>	you can be infected for between 10–15 years <i>without</i> realising it. [BNC A00 16]
79.	<i>ago</i>	*
80.	<i>into</i>	'I would like to thank you and your Team for all the effort and resources you have put <i>into</i> providing a home care service for our patients. [BNC A01 583]
81.	<i>onto</i>	*
82.	<i>between</i>	*
83.	<i>amid</i>	*
84.	<i>among</i>	*
85.	<i>against</i>	He warns us <i>against</i> being seduced by 'a new and ... illiberal 'liberal' orthodoxy' designed to accommodate demands for a law protecting Islamic sensitivities. [BNC A44 203]
86.	<i>beside</i>	*
87.	<i>during</i>	*
88.	<i>come</i>	*
89.	<i>absent</i>	*
90.	<i>counting</i>	*
91.	<i>touching</i>	*
92.	<i>respecting</i>	*
93.	<i>concerning</i>	*
94.	<i>considering</i>	*
95.	<i>following</i>	*
96.	<i>failing</i>	*
97.	<i>barring</i>	*
98.	<i>excluding</i>	*
99.	<i>including</i>	*
100.	<i>pending</i>	*
101.	<i>excepting</i>	*
102.	<i>turning</i>	*
103.	<i>pertaining</i>	*



	The functional word	Small clause comp: subject of comp is raised and pred is verbal
104.	<i>bearing</i>	*
105.	<i>having</i>	*
106.	<i>given</i>	*
107.	<i>granted</i>	*
108.	<i>provided</i>	*
109.	<i>providing</i>	*
110.	<i>supposing</i>	*
111.	<i>assuming</i>	*
112.	<i>seeing</i>	*
113.	<i>allowing</i>	*
114.	<i>bar</i>	*
115.	<i>except</i>	I could think of nothing <i>except</i> going to London and finding my way among its tall buildings studded with lights. [BNC AOU 1374]
116.	<i>if</i>	'You know it was,' said Lucy, abruptly, then as <i>if</i> making conversation. [BNC A0L 3092]
117.	<i>regardless</i>	*
118.	<i>besides</i>	Delacroix's journal is articulate, concerned with other arts as well as painting, <i>besides</i> containing much comment on contemporary life. [BNC A04 845]
119.	<i>irrespective</i>	*
120.	<i>apropos</i>	*
121.	<i>but</i>	*
122.	<i>albeit</i>	*
123.	<i>notwithstanding</i>	*
124.	<i>though</i>	Jo Richardson, <i>though</i> replying on behalf of the NEC, pointedly distanced herself from its stand. [BNC A30 322]
125.	<i>whenever</i>	albeit of the kind one hopes to run into <i>whenever</i> entering a New York bar. [BNC CLS 741]
126.	<i>wherever</i>	if we are <i>wherever</i> going to really mean it, what better time to mean it than right now when we see unemployment up [Google Web]
127.	<i>once</i> (temporal)	The committee is critical of our subsequent supervision, <i>once</i> having decided we should admit those companies. [BNC AJH 217]
128.	<i>once</i> (TIMES)	*
129.	<i>unless</i>	*
130.	<i>lest</i>	*
131.	<i>whereupon</i>	*
132.	<i>opposite</i>	*
133.	<i>beyond</i>	*
134.	<i>past</i>	*
135.	<i>below</i>	*
136.	<i>above</i>	*
137.	<i>round</i>	*
138.	<i>underneath</i>	*
139.	<i>beneath</i>	*
140.	<i>around</i>	*
141.	<i>throughout</i>	*
142.	<i>through</i>	*
143.	<i>within</i>	*
144.	<i>across</i>	*
145.	<i>inside</i>	*
146.	<i>behind</i>	*
147.	<i>alongside</i>	*
148.	<i>under</i>	*
149.	N.S.E.W.	*
150.	<i>instead</i>	*
151.	<i>minus</i>	*
152.	<i>versus</i>	*
153.	<i>per</i>	*
154.	<i>gone</i> (BrE)	*
155.	<i>since</i> (temporal)	<i>Since</i> being in Norway, he has been used to stud not only by the Norwegians but also by the top Swedish kennel Faunus, which is owned and run by Gun Berquist. [BNC AR5 444]
156.	<i>since</i> (non-temporal)	*
157.	<i>as</i> (temporal)	*
158.	<i>as</i> (causative)	*
159.	<i>on</i> (locative)	*
160.	<i>on</i> (concerning)	*
161.	<i>on</i> (non-locative)	*
162.	<i>off</i> (locative)	*
163.	<i>off</i> (non-locative)	*
164.	<i>outside</i> (locative)	*



	The functional word	Small clause comp: subject of comp is raised and pred is verbal
165.	<i>outside</i> (exception)	*
166.	<i>in</i> (locative)	*
167.	<i>in</i> (non-locative)	Your Team has been invaluable <i>in</i> providing psychological as well as practical support for these patients which have been grossly lacking through the conventional channels. [BNC A01 584]
168.	<i>that</i> (purposive)	*
169.	<i>that</i> (empty)	*
170.	<i>while</i> (temporal)	More than sixty years after the event, <i>while</i> watching a child of his own try out his first steps, he suddenly stated in reminiscence and satisfaction to his most intimate Spanish friend [BNC A04 127]
171.	<i>while</i> (concessive)	His judgements were impressive nevertheless, so that some critics were reduced to agreeing with his conclusions <i>while</i> denying the validity of his system. [BNC A04 963]
172.	<i>whilst</i> (temporal)	<i>Whilst</i> belaying you can look across a sweeping valley covered by vineyards and broken up by lines of cyprus trees. [BNC A15 919]
173.	<i>whilst</i> (concessive)	<i>Whilst</i> owing his debt to Lorca, it has to be said that this volume is markedly conservative. [BNC AOP 1461]
174.	<i>apart</i> (away)	*
175.	<i>aside</i> (away)	*
176.	<i>apart</i> (exception)	*
177.	<i>aside</i> (exception)	*
178.	<i>by</i> (non-locative)	<i>By</i> working co-operatively, long-term, with the people around me, I hope to continue for some time yet. [BNC A00 206]
179.	<i>by</i> (locative)	*
180.	<i>at</i>	*
181.	<i>about</i> (locative)	*
182.	<i>about</i> (concerning)	*
183.	<i>worth</i>	*
184.	<i>near</i>	*
185.	<i>close</i>	*
186.	<i>far</i>	*



Property 11: Small clause comp: subj of comp is raised and the pred is non-verbal

	The functional word	Small clause comp: subj of comp is raised and the pred is non-verbal
1.	<i>with</i>	*
2.	<i>for fear</i>	*
3.	<i>of</i>	*
4.	<i>in order</i>	*
5.	<i>on condition</i>	*
6.	<i>as to</i>	*
7.	<i>as for</i>	*
8.	<i>for all</i>	*
9.	<i>as soon as</i>	*
10.	<i>as long as</i>	*
11.	<i>in case</i>	*
12.	<i>in the event</i>	*
13.	<i>on the basis</i>	*
14.	<i>on the grounds</i>	*
15.	<i>to the effect</i>	*
16.	<i>all over</i>	*
17.	<i>in two minds</i>	*
18.	<i>here</i>	*
19.	<i>there</i>	*
20.	<i>now</i>	*
21.	<i>upstairs, downstairs</i>	*
22.	<i>uphill, downhill</i>	*
23.	<i>upstage, downstage</i>	*
24.	<i>upstream, downstream</i>	*
25.	<i>overseas, overboard, overhead, overland</i>	*
26.	<i>underfoot</i>	*
27.	<i>underground</i>	*
28.	<i>home</i>	*
29.	<i>outdoors, indoors</i>	*
30.	<i>back</i>	*
31.	<i>backward(s), forward(s), upward(s), downward(s), inward(s), outward(s), eastward(s), northward(s), southward(s), westward(s), eastward(s), leftward(s), rightward(s), homeward(s), skyward(s), heavenward(s), seaward(s)</i>	*
32.	<i>abroad</i>	*
33.	<i>adrift</i>	*
34.	<i>aloft</i>	*
35.	<i>aground</i>	*
36.	<i>ashore</i>	*
37.	<i>contrary</i>	*
38.	<i>counter</i>	*
39.	<i>exclusive</i>	*
40.	<i>pursuant</i>	*
41.	<i>subsequent</i>	*
42.	<i>previous</i>	*
43.	<i>preparatory</i>	*
44.	<i>preliminary</i>	*
45.	<i>prior</i>	*
46.	<i>adjacent</i>	*
47.	<i>unbeknown(st)</i>	*
48.	<i>further (reference)</i>	*
49.	<i>consequent</i>	*
50.	<i>due</i>	*
51.	<i>next</i>	*
52.	<i>away</i>	*
53.	<i>out</i>	*



	The functional word	Small clause comp: subj of comp is raised and the pred is non-verbal
54.	<i>abreast</i>	*
55.	<i>aboard</i>	*
56.	<i>down</i>	*
57.	<i>up</i>	*
58.	<i>over</i>	*
59.	<i>along</i>	*
60.	<i>ahead</i>	*
61.	<i>less</i> ('minus')	*
62.	<i>thanks</i>	*
63.	<i>owing</i>	*
64.	<i>according</i>	*
65.	<i>regarding</i>	*
66.	<i>from</i>	*
67.	<i>upon</i>	*
68.	<i>because</i>	*
69.	<i>although</i>	
70.	<i>whereas</i>	*
71.	<i>via</i>	*
72.	<i>when</i>	I found it to be quiet, even <i>when</i> under pressure. [BNC A0X 672]
73.	<i>where</i>	<i>Where</i> possible, shape the hedge so that is narrower at the top, admitting light to growth near the base. [AOG 2414]
74.	<i>until</i>	Start negotiations but do not book <i>until</i> in Nepal so you can meet the agents and potential guides before committing. [Google Web]
75.	<i>after</i>	*
76.	<i>before</i>	*
77.	<i>whether</i>	*
78.	<i>without</i>	*
79.	<i>ago</i>	*
80.	<i>into</i>	*
81.	<i>onto</i>	*
82.	<i>between</i>	*
83.	<i>amid</i>	*
84.	<i>among</i>	*
85.	<i>against</i>	*
86.	<i>beside</i>	*
87.	<i>during</i>	*
88.	<i>come</i>	*
89.	<i>absent</i>	*
90.	<i>counting</i>	*
91.	<i>touching</i>	*
92.	<i>respecting</i>	*
93.	<i>concerning</i>	*
94.	<i>considering</i>	*
95.	<i>following</i>	*
96.	<i>failing</i>	*
97.	<i>barring</i>	*
98.	<i>excluding</i>	*
99.	<i>including</i>	*
100.	<i>pending</i>	*
101.	<i>excepting</i>	Other lists suffer too, for there is no Barbara Taylor Bradford, no Wilbur Smith (<i>excepting</i> in C format), no Jeffrey Archer and no Jackie Collins. [BNC E9Y 434]
102.	<i>turning</i>	*
103.	<i>pertaining</i>	*
104.	<i>bearing</i>	<i>Bearing in mind</i> that it takes approximately 12 weeks from planting to flowering, it is possible to grow bulbs of many species [BNC A0G 684]
105.	<i>having</i>	<i>Having</i> applied cement render over the external brickwork, attached a hideous modern porch and added an extension in jarring and inappropriate modern materials, the brewery designers have gutted the interior. [BNC A0B 239]
106.	<i>given</i>	*
107.	<i>granted</i>	*
108.	<i>provided</i>	*
109.	<i>providing</i>	*
110.	<i>supposing</i>	*
111.	<i>assuming</i>	*
112.	<i>seeing</i>	*
113.	<i>allowing</i>	*
114.	<i>bar</i>	*
	The functional word	Small clause comp: subj of comp is raised and the pred is non-verbal



115.	<i>except</i>	Combine the stronger shades with care, keeping arrangements simple, <i>except in</i> mixed bedding where a lively tumult of colour is de rigueur. [BNC A0G 2588]
116.	<i>if</i>	yet dull-toned in personality to the point of satanic flatness, captured as <i>if</i> in his own despite the imagination of the day. [BNC A18 810]
117.	<i>regardless</i>	*
118.	<i>besides</i>	*
119.	<i>irrespective</i>	*
120.	<i>apropos</i>	*
121.	<i>but</i>	*
122.	<i>albeit</i>	For when a religion is put into a position where its, <i>albeit</i> necessary, business activities appear in the eyes of its followers ... [BNC BM2 231]
123.	<i>notwithstanding</i>	*
124.	<i>though</i>	The day, <i>though</i> hot, turned more promising. [BNC A0U 2575]
125.	<i>whenever</i>	The art of safe piloting is to learn to avoid the initial error <i>whenever possible</i> . [BNC A0H 107]
126.	<i>wherever</i>	to be done by filling out paperwork and has moved to a digital process <i>wherever possible</i> . [COCA, MAG TechCrunch]
127.	<i>once</i> (temporal)	*
128.	<i>once</i> (TIMES)	*
129.	<i>unless</i>	Before you buy furniture, make sure it isn't made from tropical hardwoods, <i>unless</i> from a sustainable source. [BNC A7G 696]
130.	<i>lest</i>	*
131.	<i>whereupon</i>	*
132.	<i>opposite</i>	*
133.	<i>beyond</i>	*
134.	<i>past</i>	*
135.	<i>below</i>	*
136.	<i>above</i>	*
137.	<i>round</i>	*
138.	<i>underneath</i>	*
139.	<i>beneath</i>	*
140.	<i>around</i>	*
141.	<i>throughout</i>	*
142.	<i>through</i>	*
143.	<i>within</i>	*
144.	<i>across</i>	*
145.	<i>inside</i>	*
146.	<i>behind</i>	*
147.	<i>alongside</i>	*
148.	<i>under</i>	*
149.	N.S.E.W.	*
150.	<i>instead</i>	*
151.	<i>minus</i>	*
152.	<i>versus</i>	*
153.	<i>per</i>	*
154.	<i>gone</i> (BrE)	*
155.	<i>since</i> (temporal)	*
156.	<i>since</i> (non-temporal)	*
157.	<i>as</i> (temporal)	*
158.	<i>as</i> (causative)	*
159.	<i>on</i> (locative)	*
160.	<i>on</i> (concerning)	*
161.	<i>on</i> (non-locative)	*
162.	<i>off</i> (locative)	*
163.	<i>off</i> (non-locative)	*
164.	<i>outside</i> (locative)	*
165.	<i>outside</i> (exception)	*
166.	<i>in</i> (locative)	*
167.	<i>in</i> (non-locative)	*
168.	<i>that</i> (purposive)	*
169.	<i>that</i> (empty)	*
170.	<i>while</i> (temporal)	In many cases a user will actually solve his or her own problem <i>while</i> on the phone to Neptune! [BNC A0C 632]
171.	<i>while</i> (concessive)	<i>While</i> large enough, the new route, called Cobble Inlet, was still only 14–18 inches high, and comprised an intimidating series of squeezes for some 90 metres. [BNC ARE 417]
172.	<i>whilst</i> (temporal)	Whilst in the Paralympic Village we read the quote from Mr Dick Palmer, of the British Olympic Association, 'justifying' their not allowing our athletes to wear 'their' logo. [BNC AKE 913]
173.	<i>whilst</i> (concessive)	<i>Whilst</i> useful to lawyers, the pre-trial review in the county court civil action has not been of enormous assistance to the ordinary person trying to conduct his or her own case. [BNC GVH 1619]
174.	<i>apart</i> (away)	*
175.	<i>aside</i> (away)	*
176.	<i>apart</i> (exception)	*
177.	<i>aside</i> (exception)	*
	The functional word	Small clause comp: subj of comp is raised and the pred is non-verbal



178.	<i>by</i> (non-locative)	*
179.	<i>by</i> (locative)	*
180.	<i>at</i>	*
181.	<i>about</i> (locative)	*
182.	<i>about</i> (concerning)	*
183.	<i>worth</i>	*
184.	<i>near</i>	*
185.	<i>close</i>	*
186.	<i>far</i>	*



Property 12: Complement with correlative or

	The functional word	Complement in a coordinated form
1.	<i>with</i>	*
2.	<i>for fear</i>	*
3.	<i>of</i>	*
4.	<i>in order</i>	*
5.	<i>on condition</i>	*
6.	<i>as to</i>	*
7.	<i>as for</i>	*
8.	<i>for all</i>	*
9.	<i>as soon as</i>	*
10.	<i>as long as</i>	*
11.	<i>in case</i>	*
12.	<i>in the event</i>	*
13.	<i>on the basis</i>	*
14.	<i>on the grounds</i>	*
15.	<i>to the effect</i>	*
16.	<i>all over</i>	*
17.	<i>in two minds</i>	*
18.	<i>here</i>	*
19.	<i>there</i>	*
20.	<i>now</i>	*
21.	<i>upstairs, downstairs</i>	*
22.	<i>uphill, downhill</i>	*
23.	<i>upstage, downstage</i>	*
24.	<i>upstream, downstream</i>	*
25.	<i>overseas, overboard, overhead, overland</i>	*
26.	<i>underfoot</i>	*
27.	<i>underground</i>	*
28.	<i>home</i>	*
29.	<i>outdoors, indoors</i>	*
30.	<i>back</i>	*
31.	<i>backward(s), forward(s), upward(s), downward(s), inward(s), outward(s), eastward(s), northward(s), southward(s), westward(s), eastward(s), leftward(s), rightward(s), homeward(s), skyward(s), heavenward(s), seaward(s)</i>	*
32.	<i>abroad</i>	*
33.	<i>adrift</i>	*
34.	<i>aloft</i>	*
35.	<i>aground</i>	*
36.	<i>ashore</i>	*
37.	<i>contrary</i>	*
38.	<i>counter</i>	*
39.	<i>exclusive</i>	*
40.	<i>pursuant</i>	*
41.	<i>subsequent</i>	*
42.	<i>previous</i>	*
43.	<i>preparatory</i>	*
44.	<i>preliminary</i>	*
45.	<i>prior</i>	*
46.	<i>adjacent</i>	*
47.	<i>unbeknown(st)</i>	*
48.	<i>further</i> (reference)	*



	The functional word	Complement in a coordinated form
49.	<i>consequent</i>	*
50.	<i>due</i>	*
51.	<i>next</i>	*
52.	<i>away</i>	*
53.	<i>out</i>	*
54.	<i>abreast</i>	*
55.	<i>aboard</i>	*
56.	<i>down</i>	*
57.	<i>up</i>	*
58.	<i>over</i>	*
59.	<i>along</i>	*
60.	<i>ahead</i>	*
61.	<i>less</i> ('minus')	*
62.	<i>thanks</i>	*
63.	<i>owing</i>	*
64.	<i>according</i>	*
65.	<i>regarding</i>	*
66.	<i>from</i>	*
67.	<i>upon</i>	*
68.	<i>because</i>	*
69.	<i>although</i>	*
70.	<i>whereas</i>	*
71.	<i>via</i>	*
72.	<i>when</i>	*
73.	<i>where</i>	*
74.	<i>until</i>	*
75.	<i>after</i>	*
76.	<i>before</i>	*
77.	<i>whether</i>	<i>Whether the final total is £5 or £5,000, it is all very much needed. [BNC A00 41]</i>
78.	<i>without</i>	*
79.	<i>ago</i>	*
80.	<i>into</i>	*
81.	<i>onto</i>	*
82.	<i>between</i>	*
83.	<i>amid</i>	*
84.	<i>among</i>	*
85.	<i>against</i>	*
86.	<i>beside</i>	*
87.	<i>during</i>	*
88.	<i>come</i>	*
89.	<i>absent</i>	*
90.	<i>counting</i>	*
91.	<i>touching</i>	*
92.	<i>respecting</i>	*
93.	<i>concerning</i>	*
94.	<i>considering</i>	*
95.	<i>following</i>	*
96.	<i>failing</i>	*
97.	<i>barring</i>	*
98.	<i>excluding</i>	*
99.	<i>including</i>	*
100.	<i>pending</i>	*
101.	<i>excepting</i>	*
102.	<i>turning</i>	*
103.	<i>pertaining</i>	*
104.	<i>bearing</i>	*
105.	<i>having</i>	*
106.	<i>given</i>	*
107.	<i>granted</i>	*
108.	<i>provided</i>	*
109.	<i>providing</i>	*
110.	<i>supposing</i>	*
111.	<i>assuming</i>	*
112.	<i>seeing</i>	*
113.	<i>allowing</i>	*
114.	<i>bar</i>	*
115.	<i>except</i>	*
116.	<i>if</i>	*
117.	<i>regardless</i>	*
118.	<i>besides</i>	*
119.	<i>irrespective</i>	*



	The functional word	Complement in a coordinated form
120.	<i>apropos</i>	*
121.	<i>but</i>	*
122.	<i>albeit</i>	*
123.	<i>notwithstanding</i>	*
124.	<i>though</i>	*
125.	<i>whenever</i>	*
126.	<i>wherever</i>	*
127.	<i>once</i> (temporal)	*
128.	<i>once</i> (TIMES)	*
129.	<i>unless</i>	*
130.	<i>lest</i>	*
131.	<i>whereupon</i>	*
132.	<i>opposite</i>	*
133.	<i>beyond</i>	*
134.	<i>past</i>	*
135.	<i>below</i>	*
136.	<i>above</i>	*
137.	<i>round</i>	*
138.	<i>underneath</i>	*
139.	<i>beneath</i>	*
140.	<i>around</i>	*
141.	<i>throughout</i>	*
142.	<i>through</i>	*
143.	<i>within</i>	*
144.	<i>across</i>	*
145.	<i>inside</i>	*
146.	<i>behind</i>	*
147.	<i>alongside</i>	*
148.	<i>under</i>	*
149.	N.S.E.W.	*
150.	<i>instead</i>	*
151.	<i>minus</i>	*
152.	<i>versus</i>	*
153.	<i>per</i>	*
154.	<i>gone</i> (BrE)	*
155.	<i>since</i> (temporal)	*
156.	<i>since</i> (non-temporal)	*
157.	<i>as</i> (temporal)	*
158.	<i>as</i> (causative)	*
159.	<i>on</i> (locative)	*
160.	<i>on</i> (concerning)	*
161.	<i>on</i> (non-locative)	*
162.	<i>off</i> (locative)	*
163.	<i>off</i> (non-locative)	*
164.	<i>outside</i> (locative)	*
165.	<i>outside</i> (exception)	*
166.	<i>in</i> (locative)	*
167.	<i>in</i> (non-locative)	*
168.	<i>that</i> (purposive)	*
169.	<i>that</i> (empty)	*
170.	<i>while</i> (temporal)	*
171.	<i>while</i> (concessive)	*
172.	<i>whilst</i> (temporal)	*
173.	<i>whilst</i> (concessive)	*
174.	<i>apart</i> ('away')	*
175.	<i>aside</i> ('away')	*
176.	<i>apart</i> (exception)	*
177.	<i>aside</i> (exception)	*
178.	<i>by</i> (non-locative)	*
179.	<i>by</i> (locative)	*
180.	<i>at</i>	*
181.	<i>about</i> (locative)	*
182.	<i>about</i> (concerning)	*
183.	<i>worth</i>	*
184.	<i>near</i>	*
185.	<i>close</i>	*
186.	<i>far</i>	*

Property 13: Postmodifier of NP

	The functional word	Postmodifier of NP
1.	<i>with</i>	This change has big implications for health planners and for those caring for <u>people with</u> AIDS. [BNC A00 260]
2.	<i>for fear</i>	Of course, it is always possible there are just causes <i>for fear</i> of losing someone's love. [BNC AN0 715]
3.	<i>of</i>	We also hold regular <u>meetings of</u> volunteers to discuss issues of concern and encourage one another. [BNC A00 107]
4.	<i>in order</i>	A suggestion <i>in order to</i> get everything sorted has been forwarded by the manager. [Q]
5.	<i>on condition</i>	An official on Sharon's plane, briefing reporters <i>on condition</i> of anonymity, blamed Arafat for the bombings. [COCA, News AssocPress]
6.	<i>as to</i>	*
7.	<i>as for</i>	*
8.	<i>for all</i>	*
9.	<i>as soon as</i>	Washing <i>as soon as</i> you get home from work is hard. [Q]
10.	<i>as long as</i>	My walking <i>as long as</i> it is in the park is easy. [Q]
11.	<i>in case</i>	*
12.	<i>in the event</i>	Several residents were concerned about personal liability <i>in the event</i> of contamination [COCA ACAD, EnvironHealth]
13.	<i>on the basis</i>	While intervention <i>on the basis</i> of protecting American lives might win approval because it could be classified as a humanitarian act, President Bush has apparently widened this to take in replacing one leader with another. [BNC AAB 201]
14.	<i>on the grounds</i>	Some groups also suffer the effects of <u>additional discrimination on the grounds</u> of race and sex. [BNC B01 1005]
15.	<i>to the effect</i>	Harry murmured something <i>to the effect</i> that they would all meet Margaret soon enough.
16.	<i>all over</i>	In April 1985 groups <i>all over</i> Britain get together to take part in a sponsored jailbreak from the Tower of London. [BNC A03 1008]
17.	<i>in two minds</i>	People <i>in two minds</i> are hard to convince to participate immediately in the campaign. [Q]
18.	<i>here</i>	The <u>need here</u> is to convince people that they must change their behaviour. [BNC: A00 183]
19.	<i>there</i>	He has published a second volume of autobiography, in which he deals with his years as a student at Oxford before and after the world war, and is now bursar of one of the colleges <i>there</i> . [BNC: A05 263]
20.	<i>now</i>	Any <u>time now</u> he's going to ask me to go roller-skating. [BNC: ACK 1522]
21.	<i>upstairs, downstairs</i>	The meeting's in the <u>big room upstairs</u> . [BNC A74 883]
22.	<i>uphill, downhill</i>	... and hedge to be jumped at the bottom of the dip before a <u>long run uphill</u> which led back to the last of the Vale hedges. [BNC EEW 1470]
23.	<i>upstage, downstage</i>	He enters upstage, makes a small arc and leaves by the same side, a <u>few feet downstage</u> . [BNC FU6 2082]
24.	<i>upstream, downstream</i>	The <u>next mill downstream</u> was also originally a corn mill, named The Good Intent, and now called The Limes. [BNC ANC 1846]
25.	<i>overseas, overboard, overhead, overland</i>	Many churches <i>overseas</i> are struggling to meet the AIDS challenge. [BNC A01 537]
26.	<i>underfoot</i>	Her wig is made up of bottle tops, left over from ordinary twentieth-century life, trodden into the <u>dirt underfoot</u> , pressed on to noticeboards. [BNC A6U 467]
27.	<i>underground</i>	A few yards from the exit of Upper Long Churn Cave and at a lower level is the entrance to Lower Long Churn Cave; this may also be safely explored, the gloom being diffused by daylight entering a fissure in the roof, to the point where the stream sinking in Upper Long Churn Cave enters in a waterfall after a short journey <i>underground</i> . [BNC ASU 923]
28.	<i>home</i>	They arranged to come that way again next Sunday and then turned their horses eastwards for the <u>long ride home</u> . [BNC A0N 1809]
29.	<i>outdoors, indoors</i>	In most cases cuttings are struck in a <u>sheltered place outdoors</u> , using pieces of ripe stem about 9in long. [BNC ACX 1456]
30.	<i>back</i>	A <u>few years back</u> , I bought an old desk at an auction and, when I got it home, found that the drawers had not been emptied by its previous owner. [BNC A0D 1923]



	The functional word	Postmodifier of NP
31.	<i>backward(s), forward(s), upward(s), downward(s), inward(s), outward(s), eastward(s), northward(s), southward(s), westward(s), eastward(s), leftward(s), rightward(s), homeward(s), skyward(s), heavenward(s), seaward(s)</i>	It would be a <u>major step <i>backwards</i></u> with great adverse effects,' Mr Ryzhkov said. [BNC AAK 433]
32.	<i>abroad</i>	The cap that happened to get overlooked returns the reader's gaze blankly yet unavoidably, like the bill from a <u>restaurant <i>abroad</i></u> which the conspirators find when they turn out the dead man's pockets ... [BNC A18 623]
33.	<i>adrift</i>	The Tonight Show audience — conventioners from IBM, tourists <i>adrift</i> in Hollywood — greet him with a respectful roar. [BNC CF9 567]
34.	<i>aloft</i>	Captain of the Thorhan, Olaf Peterson, tells me there were men <i>aloft</i> fitting aerials up the sides of the two of the three masts and there was talk that the gun deck of this maritime relic, renovated just before the war as a museum ship, was now equipped with the very latest in electronics. [BNC GV6 2728]
35.	<i>aground</i>	SALVAGE specialists last night called off attempts to refloat a <u>ship <i>aground</i></u> on an uninhabited island in the Pentland Firth — as pressure mounted for far tougher controls on vessels using the channel. [BNC K5D 1149]
36.	<i>ashore</i>	<u>Harvest time <i>ashore</i></u> coincided with the pilchard season at sea or, as it was said, 'Corn up in shock, Fish into rock'. [BNC B0G 383]
37.	<i>contrary</i>	We are clearly never obliged to follow any <u>human direction <i>contrary</i></u> to what we know to be scriptural or morally right. [BNC B05 491]
38.	<i>counter</i>	I have tried to emphasize the positive in this book, and in that spirit I should like to repeat that the <u>longer term <i>counter</i></u> to fighting, jealousy and acquisitiveness is to train the child, patiently and repetitively, to share, to wait patiently, to see that pulling hair hurts, to co-operate — in other words to be socially sensitive. [BNC B10 1500]
39.	<i>exclusive</i>	Still, none of these can claim a <u>historical distinctiveness <i>exclusive</i></u> to the recent past. [BNC CKP 262]
40.	<i>pursuant</i>	Therefore, the rules adopted by <u>member states <i>pursuant</i></u> to article 5(2) of that Regulation could never infringe the basic principles of Community law. [BNC FCJ 542]
41.	<i>subsequent</i>	Throughout the interaction region <u><i>subsequent</i></u> to the collision they have obtained a complete set of bounded normal modes that are expressed in terms of spin-weighted spherical harmonics. [BNC B2K 1152]
42.	<i>previous</i>	Some lines <u><i>previous</i></u> to the main speech have been incorporated here. [BNC A06 673]
43.	<i>preparatory</i>	On other occasions, the Provisionals have been hired by property speculators who wished to buy the bombed site cheaply or to reduce the value of adjacent property <u><i>preparatory</i></u> to buying it cheaply. [BNC CCC 1673]
44.	<i>preliminary</i>	Flexibility is the keynote and is a feature often recommended in pilot studies <u><i>preliminary</i></u> to a full-scale study. [BNC HPU 1434]
45.	<i>prior</i>	He had only won one match <u><i>prior</i></u> to the international, in the Regal Scottish Masters, but is well aware of his own capabilities. [BNC A1N 666]
46.	<i>adjacent</i>	In another room <u><i>adjacent</i></u> to one of his two bathrooms lies some weight-lifting equipment ... [BNC A0P 116]
47.	<i>unbeknown(st)</i>	Had she some power <u><i>unbeknown</i></u> to herself, which smoothed her way through life, she wondered. [BNC C98 2235]
48.	<i>further</i> (reference)	*
49.	<i>consequent</i>	but also a condition <u><i>consequent</i></u> to a severing from a place of origin. [COCA, ACAD Raritan]
50.	<i>due</i>	Medicinal plants are in greater demand <u><i>due</i></u> to their increased popularity ... [COCA, ACAD AnimalPlanSci]
51.	<i>next</i>	'He's been pressuring me to sell the land <u><i>next</i></u> to this house,' David said. [BNC A0D 1015]
52.	<i>away</i>	That's two counties <u><i>away</i></u> ! [BNC A0D 2443]
53.	<i>out</i>	This can cause problems, since you agree under the terms of the covenant to make payments <u><i>out</i></u> of income from which tax has been deducted. [BNC A01 283]
54.	<i>abreast</i>	As Doak describes, 'Then something startling happened.... a formation of six dolphins <u><i>abreast</i></u> of me... repeated that trick in unison, reinforcing my newly acquired mimicry patterns.' [BNC ABC 134]
55.	<i>aboard</i>	There she was met by her family and, after a joyful reunion <u><i>aboard</i></u> ship, she was collected by kennel staff and quarantined in Manchester. [BNC A17 595]



	The functional word	Postmodifier of NP
56.	<i>down</i>	Nevertheless he seemed willing enough to accompany the Finnish detective in the dangerous climb <i>down</i> over the tumbling rocks to where his cousin and his cousin's pretty, peroxidized fiancée lay. [BNC A0D 257]
57.	<i>up</i>	It is a separate tragedy altogether that, in a country where there is no nation health service, anything <i>up</i> to three million dollars can be spent killing someone. [BNC A03 748]
58.	<i>over</i>	Anything <i>over</i> this amount is, basically, liable to inheritance tax at 40%. [BNC A01 428]
59.	<i>along</i>	I just walked, all the way <i>along</i> Trumpington Road. [BNC A06 852]
60.	<i>ahead</i>	She has a great future <i>ahead</i> of her and will undoubtedly improve as here serve and volleys do. [BNC A0V 449]
61.	<i>less</i> ('minus')	In fact, it does a great deal <i>less</i> ! [BNC A0M 1040]
62.	<i>thanks</i>	*
63.	<i>owing</i>	*
64.	<i>according</i>	The major management concern <i>according to</i> Peters is not a concern with techniques but rather a concern with people, and with the division between management and non-management.. [BNC AM7 258]
65.	<i>regarding</i>	The debate <i>regarding</i> ovulation, therefore, resonated within an episteme that came to regard the female as a passive, potentially dangerous source of raw passion. [BNC ACL 985]
66.	<i>from</i>	The need for volunteers <i>from</i> churches, particularly in London and Scotland in the day-time, is an ever constant one. [BNC A00 221]
67.	<i>upon</i>	The <i>impact upon</i> the personality expectations and the way of life of a mature scholar by the University experience is not appreciated by many of the police ... [BNC A0K 376]
68.	<i>because</i>	The argument <i>because</i> he doesn't want to participate in the protest has been reported. [Q]
69.	<i>although</i>	*
70.	<i>whereas</i>	*
71.	<i>via</i>	The cost of <i>the call via</i> BT would have been £29.25 at the cheap rate after 8pm, BT confirmed. [BNC A0C 223]
72.	<i>when</i>	In those moments <i>when</i> a light was a dream or a miracle, you were light in that darkness. [BNC A03 676]
73.	<i>where</i>	No <i>matter where</i> in the world human rights violations occur — from India to Iran, Chile to Czechoslovakia — Amnesty International is there to warn the world. [BNC A03 305]
74.	<i>until</i>	In 1977 another letter came, then a long silence <i>until</i> 1981, then a letter in 1984. [BNC A03 857]
75.	<i>after</i>	The <i>major debates after</i> that time have tended to show a split between church leadership and a large section of its laity on the one hand, and a significant proportion of Roman catholic laity, other churches, and secular groups on the other. [BNC A07 1012]
76.	<i>before</i>	Important competitions need proper preparation and adequate rest the night <i>before</i> . [BNC A0M 127]
77.	<i>whether</i>	We have no idea <i>whether</i> the music matches the nomenclature, but it must be worth £5 of anyone's money to encourage them. [BNC A1K 38]
78.	<i>without</i>	Four real beginnings, wrote Harsnet, and four real rejections: the rejection of a life <i>without</i> art, the rejection of art, the rejection of any form of making, and the final rejection of all absolutes and the acceptance of compromise. [BNC A08 48]
79.	<i>ago</i>	Who a decade <i>ago</i> would have thought it possible that the chief benefactor of bus deregulation would be BR? [BNC A11 95]
80.	<i>into</i>	This brief diversion <i>into</i> the cultural and political history of Germany, the USSR and China has been made to emphasise the way that a state may determine artistic production, and thence art criticism. [BNC A04 306]
81.	<i>onto</i>	Nolan's fist began a descent <i>onto</i> the back of Sam's vulnerable neck. [BNC ADY 1193]
82.	<i>between</i>	Recently, an anonymous note, clearly composed from a dialogue <i>between</i> a prisoner and a sympathetic guard, was smuggled out. [BNC A03 871]
83.	<i>amid</i>	A <i>short stroll amid</i> the usual birches, boulders and close-cropped grass brings the first and most continuous section to hand. [BNC A04 1053]
84.	<i>among</i>	There was division <i>among</i> the Roman catholic episcopate as well and as many favoured the system as were against it. [BNC A07 1256]
85.	<i>against</i>	He denied all the charges <i>against</i> him except possession of the literature which he said was either on sale in public bookstores or did not advocate violence. [BNC A03 580]
86.	<i>beside</i>	And the stone seats <i>beside</i> the fire would be replaced with benches ... [BNC A0N 9]
87.	<i>during</i>	Its opening <i>during</i> the Falklands War was an extraordinary coincidence. [BNC A0E 510]
88.	<i>come</i>	*
89.	<i>absent</i>	*
90.	<i>counting</i>	The sum <i>counting</i> the children is £200. [BNC AE1 1512]
91.	<i>touching</i>	months we've had tens of summit meetings, at which all these burning questions <i>touching</i> on the fundamental changes in Europe were discussed. [COCA, News NYTimes]
92.	<i>respecting</i>	It has been deemed just, in consideration of the share borne by the Servians in this war, to come to a solemn agreement <i>respecting</i> their security. [BNC FSU 1338]
93.	<i>concerning</i>	In my case at least, therefore, thought, belief or knowledge <i>concerning</i> the world cannot be analysed simply in terms of dispositions to behave. [BNC A0T 201]



	The functional word	Postmodifier of NP
94.	<i>considering</i>	Although we were walking on a sunny, but chilly Saturday in early June, the ridge was completely deserted, a great bonus <i>considering</i> the weekend traffic on most Munros. [BNC AS3 863]
95.	<i>following</i>	Many political prisoners who had been sentenced to death or life imprisonment after unfair trials <i>following</i> the 1980 coup will continue to serve sentences of up to 20 years. [BNC A03 186]
96.	<i>failing</i>	All guidelines agree that vancomycin be reserved for the critically ill, or for patients <i>failing</i> or intolerant of metronidazole 4 5 6 7. [COCA, ACAD Gastroent]
97.	<i>barring</i>	Either of these faults means that the attacking technique is well developed before you move into it, and so your <i>front barring</i> arm or groin suffer accordingly. [BNC A0M 736]
98.	<i>excluding</i>	Sixty-seven per cent of men compared with 42 per cent of women were on state benefit <i>excluding</i> child benefit and retirement pension ... [BNC ALP 782]
99.	<i>including</i>	A similar course held at the beginning of the year in Brasov, attended by sixty people <i>including</i> teachers, nurses and doctors, was particularly encouraging as much of the material was, in turn, passed on to other colleagues for their use. [BNC A00 231]
100.	<i>pending</i>	At check out, a telephone bill and any messages <i>pending</i> are printed out and the guest details are removed from the directory. [BNC A0C 736]
101.	<i>excepting</i>	There are wide oak or elm floorboards in every room <i>excepting</i> the hall, which is stone flagged and from which rises a thick oak staircase with fat bannisters. [BNC A0W 125]
102.	<i>turning</i>	*
103.	<i>pertaining</i>	*
104.	<i>bearing</i>	*
105.	<i>having</i>	*
106.	<i>given</i>	*
107.	<i>granted</i>	*
108.	<i>provided</i>	*
109.	<i>providing</i>	*
110.	<i>supposing</i>	*
111.	<i>assuming</i>	*
112.	<i>seeing</i>	*
113.	<i>allowing</i>	*
114.	<i>bar</i>	*
115.	<i>except</i>	*
116.	<i>if</i>	that would only be the case <i>if</i> they brought the thaumaturge the prize he had sent them to collect. Baldemar spoke ... [COCA, FIC Fantasy & Science Fiction]
117.	<i>regardless</i>	Dinghy sailing has something to offer everyone <i>regardless</i> of age, fitness or depth of pocket. [BNC A65 1676]
118.	<i>besides</i>	There were, of course, other professional sportsmen <i>besides</i> cricketers and footballers. [BNC A6Y 376]
119.	<i>irrespective</i>	*
120.	<i>apropos</i>	It was a reworking of the same materials <i>apropos</i> Hungary as I had already seen in Prague <i>apropos</i> Czechoslovakia. [BNC AE8 1970]
121.	<i>but</i>	*
122.	<i>albeit</i>	*
123.	<i>notwithstanding</i>	Their apparent wealth <i>notwithstanding</i> , there are rumblings of unease within parts of the lieutenancy about the cost of it all. [BNC ADB 329] ¹²
124.	<i>though</i>	*
125.	<i>whenever</i>	It's a guaranteed good time whenever the Monterrey electro-rockers and party instigators take the stage. 11 p.m. [COCA, News Austin]
126.	<i>wherever</i>	But you find the time and the space <i>wherever</i> you can. [COCA, GoodHousekeeping]
127.	<i>once (temporal)</i>	*
128.	<i>once (TIMES)</i>	*
129.	<i>unless</i>	My shopping <i>unless</i> for Xmas is hard. [Q]
130.	<i>lest</i>	*
131.	<i>whereupon</i>	*
132.	<i>opposite</i>	Unfortunately, there was a row of mirrors on the wall <i>opposite</i> me. [BNC A0F 2302]
133.	<i>beyond</i>	The glacier <i>beyond</i> was dirty and torturous, but we trekked down it to reach a sandspill outfall. [BNC A6T 702]
134.	<i>past</i>	From the front door he could see her walking along the road <i>past</i> the graveyard with three of her friends, their heavy skirts swinging. [BNC A0N 62]
135.	<i>below</i>	We had emerged from a private wall into the crazy world of summer skiers, no doubt fresh from their BMWs in the car park <i>below</i> . [BNC A15 631]

¹² Due to the fact that notwithstanding seems to have a similar syntactic behaviour appearing in raising constructions, this probably suggests that *notwithstanding* here has no complement since the it seems to function as a postmodifier of the NP preceding it



	The functional word	Postmodifier of NP
136.	<i>above</i>	Height judgement <i>above</i> that height is not essential and is largely guesswork. [BNC A0H 1243]
137.	<i>round</i>	But again is always an illusion, wrote Harsnet, for it would also become clear, the second time <i>round</i> , after several weeks, that one was not doing what one had hoped to do. [BNC A08 893]
138.	<i>underneath</i>	Now the cloth above the encircling fingers seemed to move, nudged this way and that by something <i>underneath</i> . [BNC A0M 78]
139.	<i>beneath</i>	In one version, the space <i>beneath</i> the seat contains a small, stuffed cayman and, as this is the equivalent of the space beneath her skirts, there are obvious psycho-sexual overtones. [BNC A6U 417]
140.	<i>around</i>	The growth of the catholic social movements and activity of Roman catholics in trade unions and politics was rooted in this dramatic revival, which gave rise to Catholic Action and the development of catholic social studies groups <i>around</i> the world. [BNC A07 824]
141.	<i>throughout</i>	Our experience of working with the major breweries <i>throughout</i> the 1980s is that, undeniably, mistakes were made — sometimes on a very grand scale indeed. [BNC A0B 415]
142.	<i>through</i>	To prevent new HIV infections <i>through</i> a schools education programme. [BNC A02 41]
143.	<i>within</i>	... for new developments <i>within</i> the UK. [BNC A00 293]
144.	<i>across</i>	To date ACET has provided professional nursing care or practical help to over 400 individuals <i>across</i> London, excluding hardship grants and equipment loans. [BNC A00 366]
145.	<i>inside</i>	Something <i>inside</i> me had snapped. [BNC A0F 831]
146.	<i>behind</i>	Part of the reasoning <i>behind</i> the move was the search for an effective policy to contain the violence within Ireland and prevent it from spreading to Britain. [BNC A07 121]
147.	<i>alongside</i>	The caption <i>alongside</i> notes that George Davies, aged 19, is in the front row on the far right. [BNC A37 219]
148.	<i>under</i>	The caption material <i>under</i> two images reads as follows: 'In the middle nineteenth century, before photography was in general use, Pilinski of Paris was famous (and notorious) for the deceptiveness of his copies of old woodcuts. [BNC A04 615]
149.	<i>N.S.E.W.</i>	But they waited, and the roads <i>north</i> and west remained quiet. [BNC A0N 1783]
150.	<i>instead</i>	The question <i>instead</i> is whether the Fed's remedies will work. [BNC ABD 2338]
151.	<i>minus</i>	The market return <i>minus</i> the risk-free return is the risk premium that investors expect for investing in the market portfolio. [BNC HNM 83]
152.	<i>versus</i>	It wasn't a straight management <i>versus</i> union dispute; it was job preservation. [BNC
153.	<i>per</i>	This works out at the equivalent of just £10 <i>per</i> day. [BNC A01 211]
154.	<i>gone</i> (BrE)	*
155.	<i>since</i> (temporal)	Predictably, the main sufferers <i>since</i> fighting flared once more in June 1990 have been the civilian populations — Tamil, Sinhalese and Moslem. [BNC A03 794]
156.	<i>since</i> (non-temporal)	*
157.	<i>as</i> (temporal)	*
158.	<i>as</i> (causative)	*
159.	<i>on</i> (locative)	There's a message <i>on</i> the answerphone from Tony's brother. [BNC A00 375]
160.	<i>on</i> (concerning)	Those involved with ACET are now helping provide home care for one in four of all those dying with AIDS in the UK and up to 4,000 school pupils a month are now receiving education <i>on</i> the subject. [BNC A00 139]
161.	<i>on</i> (non-locative)	Some time later found he had only one shoe <i>on</i> . [BNC A08 1658]
162.	<i>off</i> (locative)	If the rope breaks, the take off field should be within easy reach for a downwind landing, whereas a problem with the twonplane's engine usually means a field landing is almost inevitable. [BNC A0H 1294]
163.	<i>off</i> (non-locative)	Many in the tourism industry believe the revenue created would far outweigh any protests that it was just another excuse for a day <i>off</i> . [BNC A0C 99]
164.	<i>outside</i> (locative)	If you've got a job <i>outside</i> the home, it's a good ideas to talk to your doctor and to your employer about the best time for you to stop work. [BNC A0J 1101]
165.	<i>outside</i> (exception)	*
166.	<i>in</i> (locative)	The care of people <i>in</i> the community, with are ill with HIV infection and AIDS, together with the education of schoolchildren to help prevent the spread of this terrible disease is becoming more and more urgent. [BNC A00 119]
167.	<i>in</i> (non-locative)	The belief <i>in</i> the integrity of Ireland is central to the unifying dominant beliefs of the alliance and is clearly distinct from the specificity of statehood. [BNC A07 603]
168.	<i>that</i> (purposive)	*
169.	<i>that</i> (empty)	Despite the fact <i>that</i> we don't hear so much about AIDS these days the problems are increasing. [BNC A01 213]
170.	<i>while</i> (temporal)	*
171.	<i>while</i> (concessive)	*
172.	<i>whilst</i> (temporal)	*
173.	<i>whilst</i> (concessive)	*
174.	<i>apart</i> ('away')	*
175.	<i>aside</i> ('away')	*
176.	<i>apart</i> (exception)	*
177.	<i>aside</i> (exception)	*



	The functional word	Postmodifier of NP
178.	by (non-locative)	It was the last locative by the spider that recalled to Quinn the tiny detail that eluded him last night. [BNC CAM 2418]
179.	by (locative)	They made way readily for Velenboom and Osrith to head to the place <i>by</i> the fire. [COCA, FIC Literary Review 2016]
180.	at	11.00am — Tony has been given an appointment <i>at</i> the local hospital. [BNC A00 388]
181.	about (movement)	The movement <i>about</i> the room was quite slow. [Q]
182.	about (concerning)	For more information <i>about</i> ACET's Home Care Service please call us on 081 840 7879 and ask for Jackie Sears. [BNC A00 291]
183.	worth	Another <u>point</u> <i>worth</i> bearing in mind is the very generalizing character of Greeley and Rossi's studies. [BNC A07 1479]
184.	near	In a <u>village</u> <i>near</i> Amiens, I found a shop where you can still get tea, and enough cakes to make a schoolboy sick for a week. [BNC A06 1160]
185.	close	Here, these have been laid in a bold <u>panel</u> <i>close</i> to the house and have also been used in strips and courses so that they tie the raised pool into the overall design of the terrace. [BNC A0G 1454]
186.	far	He was in hospital for a long time with the <u>doctors</u> <i>far</i> from optimistic that he would recover. [BNC CCC 324]



Property 14: Null head/ “NP”-distribution-like

	The functional word	Null head/ “NP”-distribution-like (As a complement of another preposition or functions as a subject)
1.	<i>with</i>	*
2.	<i>for fear</i>	*
3.	<i>of</i>	*
4.	<i>in order</i>	*
5.	<i>on condition</i>	*
6.	<i>as to</i>	*
7.	<i>as for</i>	*
8.	<i>for all</i>	*
9.	<i>as soon as</i>	*
10.	<i>as long as</i>	
11.	<i>in case</i>	*
12.	<i>in the event</i>	*
13.	<i>on the basis</i>	*
14.	<i>on the grounds</i>	*
15.	<i>to the effect</i>	*
16.	<i>all over</i>	So you have women coming across from Europe, from Asia, from <i>all over</i> the country to compete and try to land their dream job... [COCA, SPOK Fox: The Five]
17.	<i>in two minds</i>	*
18.	<i>here</i>	‘This was at the church just down the road from <i>here</i> ?’ [BNC: A0F 1859]
19.	<i>there</i>	It went on from <i>there</i> .’ [BNC: A0U 647]
20.	<i>now</i>	A year from <i>now</i> , in all likelihood, the world will look back on a merely disappointing year of little or no growth in Britain and America ... [BNC: ABD 2407]
21.	<i>upstairs, downstairs</i>	There were no longer any cries from <i>upstairs</i> . [BNC AD1 3417]
22.	<i>uphill, downhill</i>	My wife wished to take a photograph of me leaning against it from <i>uphill</i> and I have to report that the stone proved not to be immovable and now rests at the bottom of the slope. [BNC HRS 134]
23.	<i>upstage, downstage</i>	five-man orchestra playing from a bandstand that for the nightclub scenes moves toward us from <i>upstage</i> . [COCA, News ORegister]
24.	<i>upstream, downstream</i>	<i>Upstream</i> is the most interesting direction, passing a variety of fascinating buildings. [BNC ECR 508]
25.	<i>overseas, overboard, overhead, overland</i>	Some schools offer a two-year course for students who have more experience, particularly those from <i>overseas</i> . [BNC A06 147]
26.	<i>underfoot</i>	Sacks of corn were piled loosely against a wall; three sheep had wandered in from the nearby pasture and had not been expelled; there was a rank smell from <i>underfoot</i> . [BNC G1X 296]
27.	<i>underground</i>	Analysis has shown that the figureheads are of Parian marble (from the Aegean island of Paros), a particularly fine-quality marble, which was expensive because it was mined from <u>from</u> <i>underground</i> . [BNC A0U 693]
28.	<i>home</i>	It’ll be better, more straightforward with Jeff and away from <i>home</i> . [BNC A01 545]
29.	<i>outdoors, indoors</i>	He has just come from <i>outdoors</i> : his moustache is cold, and damp with dew. [BNC G1A 1203]
30.	<i>back</i>	*
31.	<i>backward(s), forward(s), upward(s), downward(s), inward(s), outward(s), eastward(s), northward(s), southward(s), westward(s), eastward(s), leftward(s), rightward(s), homeward(s), skyward(s), heavenward(s), seaward(s)</i>	The boy hovered there for a minute, shifting his weight from seatward to <i>backward</i> , then he moved on. [COCA, FIC Ploughshares]
32.	<i>abroad</i>	He has arrived from <i>abroad</i> , yet another bird of passage, ‘in the hope of getting a job building our railway bridge’. [BNC A18 1288]
33.	<i>adrift</i>	*
34.	<i>aloft</i>	As the Welfare lurched and another thundering beating of canvas came from <i>aloft</i> , Mr Allgood emerged from the group. [BNC EC8 660]
35.	<i>aground</i>	*



	The functional word	Null head/ "NP"-distribution-like (As a complement of another preposition or functions as a subject)
36.	<i>ashore</i>	board sad weeping ice-cream parties for gangs of embarrassed native boys the steward shanghaied from <i>ashore</i> . [COCA, FIC Bk:SummerCrossing]
37.	<i>contrary</i>	*
38.	<i>counter</i>	*
39.	<i>exclusive</i>	*
40.	<i>pursuant</i>	*
41.	<i>subsequent</i>	*
42.	<i>previous</i>	*
43.	<i>preparatory</i>	*
44.	<i>preliminary</i>	*
45.	<i>prior</i>	*
46.	<i>adjacent</i>	*
47.	<i>unbeknown(st)</i>	*
48.	<i>further</i> (reference)	*
49.	<i>consequent</i>	*
50.	<i>due</i>	*
51.	<i>next</i>	<i>Next</i> to me sat an old me with a big walking stick. [Q]
52.	<i>away</i>	A few feet <i>away</i> from me sat an old me with a big walking stick. [Q]
53.	<i>out</i>	From <i>out</i> of the water rose a ferocious piece of metal covered in seaweed, barnacles and winkles. [BNC AMB 1497]
54.	<i>abreast</i>	*
55.	<i>aboard</i>	The evidence from <i>abroad</i> is that outlawing hacking has not stopped it. [A5A 164]
56.	<i>down</i>	You might see things differently from <i>down</i> there. [BNC CFJ 1749]
57.	<i>up</i>	You can see a long way from <i>up</i> here,' said Simon. [BNC ACB 1650]
58.	<i>over</i>	'Come on, Angus,' Donald persisted, 'let us hear a song from <i>over</i> the mountains. [BNC A0N 1340]
59.	<i>along</i>	There was a bang, and a flutter of suppressed laughter from <i>along</i> the corridor. [BNC H8Y 1984]
60.	<i>ahead</i>	'We begin descending into the Vale tomorrow,' Bicker called from <i>ahead</i> . [BNC GWF 2399]
61.	<i>less</i> ('minus')	*
62.	<i>thanks</i>	*
63.	<i>owing</i>	*
64.	<i>according</i>	*
65.	<i>regarding</i>	*
66.	<i>from</i>	*
67.	<i>upon</i>	*
68.	<i>because</i>	*
69.	<i>although</i>	*
70.	<i>whereas</i>	*
71.	<i>via</i>	a quiet neighborhood on the north edge of town that you entered from <i>via</i> Faentina. [COCA, FIC Ploughshares]
72.	<i>when</i>	The drama school will give you some advice on <i>when</i> and where to write to, and how you organise your letters, but outside advice is very important in helping you to see yourself in perspective. [BNC A06 1489]
73.	<i>where</i>	I know from <i>where</i> it comes and where it wishes to get to. [BNC A08 1240]
74.	<i>until</i>	*
75.	<i>after</i>	Why didn't you save up the bad news for <i>after</i> May 5? [BNC A4K 367]
76.	<i>before</i>	Features dating from <i>before</i> World War I were still commonly encountered. [BNC A11 1303]
77.	<i>whether</i>	*
78.	<i>without</i>	*
79.	<i>ago</i>	*
80.	<i>into</i>	*
81.	<i>onto</i>	*
82.	<i>between</i>	He came to, and knocked the burning cigarette end from <i>between</i> his fingers. [BNC B3J 2597]
83.	<i>amid</i>	... at the public floggings from <i>amid</i> the crowd of frightened coolies on the first truck ... [BNC FU8 2210]
84.	<i>among</i>	The fourth way of finding acts is from <i>among</i> an agent's existing managers. [BNC A6A 845]
85.	<i>against</i>	From <i>against</i> the comforting strength of adults, he is undetected. [COCA, FIC Bk:Arcadia]
86.	<i>beside</i>	... his wife answered from <i>beside</i> the fireplace. [BNC A0N 1620]
87.	<i>during</i>	The visiting shooter hit excellent from <i>during</i> the second quarter ... [BNC BM4 2262]
88.	<i>come</i>	*
89.	<i>absent</i>	*
90.	<i>counting</i>	*



	The functional word	Null head/ "NP"-distribution-like (As a complement of another preposition or functions as a subject)
91.	<i>touching</i>	*
92.	<i>respecting</i>	*
93.	<i>concerning</i>	*
94.	<i>considering</i>	*
95.	<i>following</i>	*
96.	<i>failing</i>	*
97.	<i>barring</i>	*
98.	<i>excluding</i>	*
99.	<i>including</i>	*
100.	<i>pending</i>	*
101.	<i>excepting</i>	*
102.	<i>turning</i>	*
103.	<i>pertaining</i>	*
104.	<i>bearing</i>	*
105.	<i>having</i>	*
106.	<i>given</i>	*
107.	<i>granted</i>	*
108.	<i>provided</i>	*
109.	<i>providing</i>	*
110.	<i>supposing</i>	*
111.	<i>assuming</i>	*
112.	<i>seeing</i>	*
113.	<i>allowing</i>	*
114.	<i>bar</i>	*
115.	<i>except</i>	*
116.	<i>if</i>	*
117.	<i>regardless</i>	*
118.	<i>besides</i>	*
119.	<i>irrespective</i>	*
120.	<i>apropos</i>	*
121.	<i>but</i>	*
122.	<i>albeit</i>	*
123.	<i>notwithstanding</i>	*
124.	<i>though</i>	*
125.	<i>whenever</i>	*
126.	<i>wherever</i>	*
127.	<i>once</i> (temporal)	*
128.	<i>once</i> (TIMES)	*
129.	<i>unless</i>	*
130.	<i>lest</i>	*
131.	<i>whereupon</i>	*
132.	<i>opposite</i>	Simple geometry can tell how far away a star is by viewing it from <i>opposite</i> sides of the Earth's solar orbit. [COCA, MAG ScienceNews]
133.	<i>beyond</i>	Even as he uttered the words a strange noise could be heard from <i>beyond</i> the French windows. [BNC A0D 726]
134.	<i>past</i>	Study participants needed to have used either heroin or methamphetamine at least once during <i>past</i> the 30 days and at least 3 times during the past 3 months ... [COCA ACAD SexResearch]
135.	<i>below</i>	No one seriously expects revolution in East Germany <i>from below</i> . [BNC A27 139]
136.	<i>above</i>	At first Sergeant Bramble thought it was one of the latest Atco motor-mowers but it seemed to be coming <i>from above</i> them [BNC A0D 727]
137.	<i>round</i>	Carlie also claimed that when she was two months old a baby-sitter had stolen a gold cross <i>from round</i> her neck. [BNC ALH 2193]
138.	<i>underneath</i>	Steam came from <i>underneath</i> one of the doors and there was the sound of a shower running. [BNC BOU 1375]
139.	<i>beneath</i>	... a magnolia bud of a tit peeping from <i>beneath</i> bed linen as she held out her arms to her lover and the lights went down at the end of the play. [BNC AC3 2089]
140.	<i>around</i>	Based in the international press room along with some 60 or so other reporters from <i>around</i> the world, Mace watches, records and listens, aware that any time, his imminent live report could easily be overtaken by events. [BNC A0V 309]
141.	<i>throughout</i>	They are recruited <i>from throughout</i> Nepal and among the aircrews will be men who know the crash area intimately. [BNC CH2 9355]
142.	<i>through</i>	'Room service,' said the waiter, glancing down at the tip of the silencer he could see pointed at him <i>from through</i> the white cloth covering the lower part of the trolley. [BNC CE5 3480]
143.	<i>within</i>	From <i>within</i> this perspective bishops and clergy lay down rules for the laity to follow in any given situation and the teaching of the church is seen as absolutely clear and devoid of problematic. [BNC A07 417]
144.	<i>across</i>	She called out to me from <i>across</i> the room. [BNC A0F 1809]
145.	<i>inside</i>	'Andrew!' called my father from <i>inside</i> . [BNC A0D 1859]



	The functional word	Null head/ “NP”-distribution-like (As a complement of another preposition or functions as a subject)
146.	<i>behind</i>	His mother's voice was cold from <i>behind</i> the make-up towel. [BNC A0D 1354]
147.	<i>alongside</i>	The key light is then added, angled on to the subject from <i>alongside</i> the camera. [BNC CBP 1429]
148.	<i>under</i>	Small creatures poured into the room, from <i>under</i> the door, screaming. [BNC A0R 3056]
149.	N.S.E.W.	The couple, from <i>north</i> London, deny murdering seven-month-old Christopher Palmer last December. [BNC ADY 2616]
150.	<i>instead</i>	*
151.	<i>minus</i>	*
152.	<i>versus</i>	*
153.	<i>per</i>	*
154.	<i>gone</i> (BrE)	*
155.	<i>since</i> (temporal)	Such specimens have not been bred from <i>since</i> their problem was discovered ... [BNC BMG 1540]
156.	<i>since</i> (non-temporal)	*
157.	<i>as</i> (temporal)	*
158.	<i>as</i> (causative)	*
159.	<i>on</i> (locative)	What about <i>on</i> the beach? [BNC ACB 3417]
160.	<i>on</i> (concerning)	*
161.	<i>on</i> (non-locative)	*
162.	<i>off</i> (locative)	He pulled Willie's clothes from <i>off</i> the line and handed them to him. [BNC CAB 433]
163.	<i>off</i> (non-locative)	*
164.	<i>outside</i> (locative)	Gradually there arose a faint humming from <i>outside</i> the tent as people gathered to talk and speculate, so it seemed as if those left inside were surrounded by a swarm of curious but not unfriendly bees. [BNC A0D 948]
165.	<i>outside</i> (exception)	*
166.	<i>in</i> (locative)	Ralph Sinnott makes a desk and chair, while Hazel Rogers moves from the box she wrote about <i>in</i> the April issue, to a nest of tables. [BNC A0X 1788]
167.	<i>in</i> (non-locative)	*
168.	<i>that</i> (purposive)	*
169.	<i>that</i> (empty)	However, despite <i>that</i> the technology is ready and there is a significant interest from both industry and investors [COCA, MAG TechCrunch]
170.	<i>while</i> (temporal)	*
171.	<i>while</i> (concessive)	*
172.	<i>whilst</i> (temporal)	*
173.	<i>whilst</i> (concessive)	*
174.	<i>apart</i> ('away')	*
175.	<i>aside</i> ('away')	*
176.	<i>apart</i> (exception)	*
177.	<i>aside</i> (exception)	*
178.	<i>by</i> (non-locative)	*
179.	<i>by</i> (locative)	'Problems?' asked a deep voice from <i>by</i> the window. [BNC JXU 1682]
180.	<i>at</i>	Many farmers won't let go, and turn up when the pressure is on, such as <i>at</i> harvest time. [BNC: ACR 1148]
181.	<i>about</i> (movement)	*
182.	<i>about</i> (concerning)	*
183.	<i>worth</i>	*
184.	<i>near</i>	He had not been impaled, but the spike had been driven far upwards from <i>near</i> his throat before his body had slumped clear. [BNC A0D 263]
185.	<i>close</i>	The common furniture beetle can be found in both hardwood and softwood, chiefly in the sapwood from <i>close</i> to the bark. [BNC A79 86]
186.	<i>far</i>	Obeying Yazov, he sent a force of paratroops to Moscow with <i>far from</i> clear orders. [BNC K5M 9269]



Property 15: Measure phrase

	The functional word	Measure phrase
1.	<i>with</i>	*
2.	<i>for fear</i>	*
3.	<i>of</i>	*
4.	<i>in order</i>	*
5.	<i>on condition</i>	*
6.	<i>as to</i>	*
7.	<i>as for</i>	*
8.	<i>for all</i>	*
9.	<i>as soon as</i>	*
10.	<i>as long as</i>	*
11.	<i>in case</i>	*
12.	<i>in the event</i>	*
13.	<i>on the basis</i>	*
14.	<i>on the grounds</i>	*
15.	<i>to the effect</i>	*
16.	<i>all over</i>	*
17.	<i>in two minds</i>	*
18.	<i>here</i>	*
19.	<i>there</i>	*
20.	<i>now</i>	*
21.	<i>upstairs, downstairs</i>	He walked 515 feet <i>upstairs</i> . [BNC DK3 345]
22.	<i>uphill, downhill</i>	just 10–15 minutes' walk <i>uphill</i> from the centre of town [BNC ECF 541]
23.	<i>upstage, downstage</i>	It smashed like a grenade about five feet <i>downstage</i> from where she stood. She was very proud that she hadn't jumped, [COCA, FIC Ploughshares]
24.	<i>upstream, downstream</i>	We walked fifteen miles <i>upstream</i> . [BNC FBM 1186]
25.	<i>overseas, overboard, overhead, overland</i>	*
26.	<i>underfoot</i>	Nonetheless, I still brought Salomon Czars, which spread 110 millimeters <i>underfoot</i> and never claimed to be lightweight. [COCA, Mag Skiing]
27.	<i>underground</i>	She was imprisoned 12 feet <i>underground</i> in a narrow chamber for a day until a man walking his dogs discovered her and called the RSPCA. [BNC K52 611]
28.	<i>home</i>	*
29.	<i>outdoors, indoors</i>	He jumped three steps <i>indoors</i> .
30.	<i>back</i>	*
31.	<i>backward(s), forward(s), upward(s), downward(s), inward(s), outward(s), eastward(s), northward(s), southward(s), westward(s), eastward(s), leftward(s), rightward(s), homeward(s), skyward(s), heavenward(s), seaward(s)</i>	He was hit by a stolen car at a combined impact speed of 120 miles per hour which forced his car 100 metres <i>backwards</i> and destroyed the whole side of the car. [BNC HAU 35]
32.	<i>abroad</i>	*
33.	<i>adrift</i>	*
34.	<i>aloft</i>	One of the monks must have climbed up an internal shaft and emerged at the very summit of the volcano two hundred metres <i>aloft</i> .
35.	<i>aground</i>	*
36.	<i>ashore</i>	*
37.	<i>contrary</i>	*
38.	<i>counter</i>	*
39.	<i>exclusive</i>	*
40.	<i>pursuant</i>	*
41.	<i>subsequent</i>	*
42.	<i>previous</i>	*
43.	<i>preparatory</i>	*
44.	<i>preliminary</i>	*
45.	<i>prior</i>	*
46.	<i>adjacent</i>	*



	The functional word	Measure phrase
47.	<i>unbeknown(st)</i>	*
48.	<i>further</i> (reference)	*
49.	<i>consequent</i>	*
50.	<i>due</i>	*
51.	<i>next</i>	*
52.	<i>away</i>	Then the stance would only be ten feet <i>away</i> and perhaps there would be a hook placement? [BNC A15 596]
53.	<i>out</i>	Park City, 25 miles <i>out</i> of Salt Lake, is an old mining town Brigham Young would hardly have cared for. [BNC A8N 186]
54.	<i>abreast</i>	*
55.	<i>aboard</i>	*
56.	<i>down</i>	Eleven years <i>down</i> that path he now has a far greater appreciation of dogs and the people who handle them professionally. [BNC A17 1499]
57.	<i>up</i>	Don't bother, I said, it's six floors <i>up</i> . [BNC A6E 552]
58.	<i>over</i>	PLANS to turn the site of a former explosives factory at Annan, Dumfriesshire, into Scotland's top rallying centre were put forward yesterday by the 300-strong Wigton Motor Club which is based a few miles <i>over</i> the border in Cumbria. [K5D 353]
59.	<i>along</i>	he moves the camera 30 to 40 yards <i>along</i> the trail toward the buck's bedding area. [COCA, MAG FieldStream]
60.	<i>ahead</i>	... and on the way home I walked stiffly three yards <i>ahead</i> of her. [BNC A5K 215]
61.	<i>less</i> ('minus')	*
62.	<i>thanks</i>	*
63.	<i>owing</i>	*
64.	<i>according</i>	*
65.	<i>regarding</i>	*
66.	<i>from</i>	... the shops were located 700 yards <i>from</i> the property. [BNC A10 825]
67.	<i>upon</i>	*
68.	<i>because</i>	*
69.	<i>although</i>	*
70.	<i>whereas</i>	*
71.	<i>via</i>	*
72.	<i>when</i>	*
73.	<i>where</i>	*
74.	<i>until</i>	Maggie felt a little burst of adrenaline surge into her bloodstream. Only five hours <i>until</i> she would see Dr. Golding-jake-again. She headed for the shower ... [COCA 2000]
75.	<i>after</i>	Ten years <i>after</i> the discovery of AIDS we are entering into a new era in the global pandemic, with growing concern about our ability to confront it successfully. [BNC A00 239]
76.	<i>before</i>	Three days <i>before</i> she came back, I cleaned the flat, bought a new jacket and five bright new cotton shirts, stayed sober, worked like hell on the magazine in a way that made Francis 'gasp and stretch his eyes'. [BNC A0L 1243]
77.	<i>whether</i>	*
78.	<i>without</i>	*
79.	<i>ago</i>	* ¹³
80.	<i>into</i>	Five months <i>into</i> the project, we are now at a manageable level and tonight we arrange to open a further six fields over the next week. [BNC A77 1642]
81.	<i>onto</i>	*
82.	<i>between</i>	*
83.	<i>amid</i>	*
84.	<i>among</i>	*
85.	<i>against</i>	*
86.	<i>beside</i>	*
87.	<i>during</i>	*
88.	<i>come</i>	*
89.	<i>absent</i>	*
90.	<i>counting</i>	*
91.	<i>touching</i>	*
92.	<i>respecting</i>	*
93.	<i>concerning</i>	*
94.	<i>considering</i>	*
95.	<i>following</i>	*
96.	<i>failing</i>	*
97.	<i>barring</i>	*
98.	<i>excluding</i>	*
99.	<i>including</i>	*
100.	<i>pending</i>	*

¹³ The NP that precedes *ago* syntactically and semantically looks like a measure phrase. However, due to its obligatoriness, it is assumed that the complement of *ago* and precedes it rather than following it.



	The functional word	Measure phrase
101.	<i>excepting</i>	*
102.	<i>turning</i>	*
103.	<i>pertaining</i>	*
104.	<i>bearing</i>	*
105.	<i>having</i>	*
106.	<i>given</i>	*
107.	<i>granted</i>	*
108.	<i>provided</i>	*
109.	<i>providing</i>	*
110.	<i>supposing</i>	*
111.	<i>assuming</i>	*
112.	<i>seeing</i>	*
113.	<i>allowing</i>	*
114.	<i>bar</i>	*
115.	<i>except</i>	*
116.	<i>if</i>	*
117.	<i>regardless</i>	*
118.	<i>besides</i>	*
119.	<i>irrespective</i>	*
120.	<i>apropos</i>	*
121.	<i>but</i>	*
122.	<i>albeit</i>	*
123.	<i>notwithstanding</i>	*
124.	<i>though</i>	*
125.	<i>whenever</i>	*
126.	<i>wherever</i>	*
127.	<i>once</i> (temporal)	*
128.	<i>once</i> (TIMES)	*
129.	<i>unless</i>	*
130.	<i>lest</i>	*
131.	<i>whereupon</i>	*
132.	<i>opposite</i>	Two linemen are lining up three yards <i>opposite</i> each other, with small bags to their left and to their right. [COCA, 2015]
133.	<i>beyond</i>	He had found the observation post two miles <i>beyond</i> the outer rim of the Jabal Hamrin. [BNC CLD 1218]
134.	<i>past</i>	It was at least ten summers <i>past</i> that the Colonel and Miss Danziger had met at The Tamarisks and the Colonel ... [BNC AEA 1091]
135.	<i>below</i>	Global sea level was 120 metres <i>below</i> the present level during the Ice Age. [BNC AAG 114]
136.	<i>above</i>	Today Great Britain's No.1 for the Trophy, Clare Wood, a vicar's daughter from Sussex, takes on Amy Frazier, who is 140 places <i>above</i> her in the rankings. [BNC A99 236]
137.	<i>round</i>	And how long would it take to go round the Isle of Wight, which is <u>sixty miles round</u> the Isle of Wight? [BNC KE2 6542]
138.	<i>underneath</i>	Fifty feet <i>underneath</i> the Daphne sits the JSL II; its pilot and a scientist are packed inside [COCA, Mag Smithsonian]
139.	<i>beneath</i>	its destructive force was limited by its depth — <u>100-150 km beneath</u> the earth's surface. [BNC HKU 1571]
140.	<i>around</i>	... to cycle <u>600 kilometres around</u> the road via Kiruna and Abisko. [BNC A6T 1268]
141.	<i>throughout</i>	*
142.	<i>through</i>	William Hazlitt, the nineteen-year-old son of the minister at Wem, had walked ten miles <i>through</i> the winter mud to hear the preaching of the now-celebrated poet and philosopher. [BNC BOR 1061]
143.	<i>within</i>	... and killer whales have been reported making use of late winter polynyas several <u>hundred kilometres within</u> the pack ice edge (Hempel and Stonehouse, 1987). [BNC G1E 1136]
144.	<i>across</i>	We detected a circle <u>20 metres across</u> . [BNC A4C 43]
145.	<i>inside</i>	Baxter found that a sow would cover her <u>30 kilometres inside</u> a pen five metres square, and that several sows would happily farrow down together within such a small space. [BNC BMD 535]
146.	<i>behind</i>	Biasion won the first three of the morning's special stages but then lost valuable seconds when he spun and lies fourth overall, two minutes <i>behind</i> Fiorio. [BNC A4P 436]
147.	<i>alongside</i>	*
148.	<i>under</i>	... when he holds the rod he feels that the water is <u>five feet under</u> the ground ... [BNC CK1 752]
149.	N.S.E.W.	Malta, 220 miles <i>north</i> of Libya, has long-standing links with Tripoli. [BNC AKR 574]
150.	<i>instead</i>	*
151.	<i>minus</i>	*
152.	<i>versus</i>	*
153.	<i>per</i>	*
154.	<i>gone</i> (BrE)	*
155.	<i>since</i> (temporal)	*



	The functional word	Measure phrase
156.	since (non-temporal)	*
157.	as (temporal)	*
158.	as (causative)	*
159.	on (locative)	Ten days <i>on</i> the ocean gave him a few chances to visit the cabins of single women [BNC A0U 2403]
160.	on (concerning)	*
161.	on (non-locative)	Twelve months <i>on</i> , Sir Angus is not really worried on either score. [BNC A1J 163]
162.	off (locative)	The trawler had been fishing five miles <i>off</i> the coast in international waters but within the prohibited area.
163.	off (non-locative)	There are fears of family life going down the drain, as staff may get only <u>two complete weekends off</u> in seven. [BNC A4N 72]
164.	outside (locative)	Three miles <i>outside</i> the Academy gates, the sleepers from Sennybridge are woken up, propped up and generally made to look like smart, alert soldiers entering a military environment. [BNC A77 533]
165.	outside (exception)	*
166.	in (locative)	We were nearly a mile and a quarter out, the set was another quarter away from us, and already it was fleecy at the top, throwing up spray a <u>hundred yards in</u> the air. [BNC ASV 788]
167.	in (non-locative)	*
168.	that (purposive)	*
169.	that (empty)	*
170.	while (temporal)	*
171.	while (concessive)	*
172.	whilst (temporal)	*
173.	whilst (concessive)	*
174.	apart (away)	They were about <u>five yards apart</u> and he was just deciding they weren't anything to do with him when they both took out pistols. [BNC H86 941]
175.	aside (away)	They were about <u>five yards aside</u> and he was just deciding they weren't anything to do with him when they both took out pistols. [BNC H12 941]
176.	apart (exception)	*
177.	aside (exception)	*
178.	by (non-locative)	*
179.	by (locative)	It misses right and goes two feet by. [COCA News USA TODAY 2017]
180.	at	*
181.	about (locative)	*
182.	about (concerning)	*
183.	worth	*
184.	near	*
185.	close	*
186.	far	*



Property 16: Right/Straight modifiers

	The functional word	Right/straight modifiers
1.	<i>with</i>	*
2.	<i>for fear</i>	*
3.	<i>of</i>	*
4.	<i>in order</i>	*
5.	<i>on condition</i>	*
6.	<i>as to</i>	*
7.	<i>as for</i>	*
8.	<i>for all</i>	*
9.	<i>as soon as</i>	*
10.	<i>as long as</i>	*
11.	<i>in case</i>	*
12.	<i>in the event</i>	*
13.	<i>on the basis</i>	*
14.	<i>on the grounds</i>	*
15.	<i>to the effect</i>	*
16.	<i>all over</i>	If you don't there's plenty of people out there that do and they'll walk right <i>all over</i> you to get what they want. [BNC JND 405]
17.	<i>in two minds</i>	*
18.	<i>here</i>	Yes, he's right <i>here</i> . [BNC AEO 1155]
19.	<i>there</i>	'Now, let's stop right <i>there</i> ,' George said sharply, and his voice was louder than he meant it to be. [BNC AN8 2245]
20.	<i>now</i>	I want an answer, right <i>now</i> !' [BNC: A0F 93]
21.	<i>upstairs, downstairs</i>	It was right <i>upstairs</i> above the shop and all the women were nice. [BNC CK9 276]
22.	<i>uphill, downhill</i>	Walk past three metal gates along the track and go right <i>uphill</i> . [BNC CHH 1409]
23.	<i>upstage, downstage</i>	By which time there is general panic right <i>upstage</i> . [BNC FU6 2843]
24.	<i>upstream, downstream</i>	... with one branch pointing across the cables, and the other angled straight <i>downstream</i> . [COCA, MAG Daily Beast]
25.	<i>overseas, overboard, overhead, overland</i>	Just as in the 1914 war, the first effect to be felt was that of large numbers of operating and engineering staff joining the forces and London Transport had its own Territorial Unit who went to camp in August 1939 and were sent straight <i>overseas</i> without returning to work. [BNC CBK 1048]
26.	<i>underfoot</i>	The god I'm praying to is here, right <i>underfoot</i> of us. [COCA, FIC]
27.	<i>underground</i>	Indeed, if you go back to his grandfather's generation, they go right <i>underground</i> , for Bill Larnach comes from the solid traditions of the Durham miners. [BNC H45 670]
28.	<i>home</i>	I did not wish to go straight <i>home</i> . [BNC BN3 2066]
29.	<i>outdoors, indoors</i>	'Straight <i>indoors</i> .' [BNC J19 1221]
30.	<i>back</i>	When that happens, he wrote, I don't just feel I'm not moving forward, I feel I'm sliding right <i>back</i> . [BNC A08 2028]
31.	<i>backward(s), forward(s), upward(s), downward(s), inward(s), outward(s), eastward(s), northward(s), southward(s), westward(s), eastward(s), leftward(s), rightward(s), homeward(s), skyward(s), heavenward(s), seaward(s)</i>	The ears of an angry horse are also likely to point straight <i>backwards</i> , and are held firmly, unlike when the horse is simply relaxed or even listening to something behind it. [BNC ADF 559]
32.	<i>abroad</i>	He went straight <i>abroad</i> . [BNC A0D 594]
33.	<i>adrift</i>	*
34.	<i>aloft</i>	It went off like Moby-Dick sighing straight <i>aloft</i> . [COCA, FIC NewYorker]
35.	<i>aground</i>	*
36.	<i>ashore</i>	a low-key fishing operation on the west side of the lake, straight <i>ashore</i> from the north end of the crack dividing the ice in St. Albin's Bay ... [COCA, MAG Smithsonian]
37.	<i>contrary</i>	*
38.	<i>counter</i>	*

	The functional word	Right/straight modifiers
39.	<i>exclusive</i>	*
40.	<i>pursuant</i>	*
41.	<i>subsequent</i>	*
42.	<i>previous</i>	*
43.	<i>preparatory</i>	*
44.	<i>preliminary</i>	*
45.	<i>prior</i>	*
46.	<i>adjacent</i>	A part of their brain has extended out right <i>adjacent</i> to their limbic system. [COCA, SPOK CNN: CNN Live Event]
47.	<i>unbeknown(st)</i>	*
48.	<i>further</i> (reference)	*
49.	<i>consequent</i>	*
50.	<i>due</i>	*
51.	<i>next</i>	He was <i>right next</i> to the linesman when he called him a name and he deserved to go. [BNC CH7 4298]
52.	<i>away</i>	I'll go <i>right away</i> . [BNC A73 472]
53.	<i>out</i>	'For Sale' sign had put it <i>right out</i> of his head. [BNC ABX 1523]
54.	<i>abreast</i>	That means that in fifteen seconds, he will be <i>right abreast</i> of you [BNC A7F 1980]
55.	<i>aboard</i>	Myself will straight <i>aboard</i> , and to the state # This heavy act with heavy heart relate. [COCA, ACAD Comparative Drama]
56.	<i>down</i>	You have to get <i>right down</i> as far as you can. [BNC A61 554]
57.	<i>up</i>	But it also went <i>right up</i> to the fifties. [BNC A6E 232]
58.	<i>over</i>	They went <i>right over</i> the top. [BNC AJM 52]
59.	<i>along</i>	At the top of Via Durini go <i>right along</i> Via Borgogna. [BNC ANB 1143]
60.	<i>ahead</i>	Go <i>right ahead</i> , don't ask me how I feel.' [BNC G0S 1984]
61.	<i>less</i> ('minus')	*
62.	<i>thanks</i>	*
63.	<i>owing</i>	*
64.	<i>according</i>	*
65.	<i>regarding</i>	*
66.	<i>from</i>	The general situation had been most unsatisfactory <i>right from</i> the start in 191 7. [BNC A64 359]
67.	<i>upon</i>	Her finger was <i>right upon</i> Barbara's nose, and Barbara moved as if a bug had landed on her [COCA, FIC GettysburgRev]
68.	<i>because</i>	*
69.	<i>although</i>	*
70.	<i>whereas</i>	*
71.	<i>via</i>	*
72.	<i>when</i>	... the time is <i>right when</i> unmarried women were [unclear] property and he thought it wouldn't be long before married women to hold property too ... [BNC HUF 214]
73.	<i>where</i>	<i>right where</i> the buildings ended and the scrub began. [BNC C86 3802]
74.	<i>until</i>	He came into the office <i>right until</i> the last days of his illness. [BNC CBU 473]
75.	<i>after</i>	But he clammed up <i>right after</i> that. [BNC A6E 385]
76.	<i>before</i>	You know it's busy getting things straight <i>before</i> harvest. [BNC AC4 139]
77.	<i>whether</i>	*
78.	<i>without</i>	*
79.	<i>ago</i>	*
80.	<i>into</i>	Track soon bends <i>right into</i> woods. [BNC A65 1183]
81.	<i>onto</i>	Inside, the small terraced front entrance leads into a large, marble-floored lounge-bar and other public rooms include a ground floor restaurant which has wide windows and doors giving access <i>right onto</i> the beach. [BNC ECF 2841]
82.	<i>between</i>	We'll make it <i>right between</i> us. [BNC FAB 3640]
83.	<i>amid</i>	... were still under stress " and trying to get their own records straight <i>amid</i> continuing investigations by authorities, said Alex Crosby, a medical epidemiologist ... [COCA, News WashPost]
84.	<i>among</i>	He found that he could sit <i>right among</i> them, and equipped with faster film ... [BNC EFF 568]
85.	<i>against</i>	They kept the people <i>right against</i> France. [BNC FB7 478]
86.	<i>beside</i>	It was <i>right beside</i> me! [BNC BMS 1074]
87.	<i>during</i>	What's interesting is -- is -- is Wenner came along <i>right during</i> the Monterey Pop Festivals. [COCA, SPOK CBS: This Morning]
88.	<i>come</i>	*
89.	<i>absent</i>	*
90.	<i>counting</i>	*
91.	<i>touching</i>	*



	The functional word	Right/straight modifiers
92.	<i>respecting</i>	*
93.	<i>concerning</i>	*
94.	<i>considering</i>	*
95.	<i>following</i>	*
96.	<i>failing</i>	*
97.	<i>barring</i>	*
98.	<i>excluding</i>	*
99.	<i>including</i>	*
100.	<i>pending</i>	*
101.	<i>excepting</i>	*
102.	<i>turning</i>	*
103.	<i>pertaining</i>	*
104.	<i>bearing</i>	*
105.	<i>having</i>	*
106.	<i>given</i>	*
107.	<i>granted</i>	*
108.	<i>provided</i>	*
109.	<i>providing</i>	*
110.	<i>supposing</i>	*
111.	<i>assuming</i>	*
112.	<i>seeing</i>	*
113.	<i>allowing</i>	*
114.	<i>bar</i>	*
115.	<i>except</i>	*
116.	<i>if</i>	*
117.	<i>regardless</i>	*
118.	<i>besides</i>	*
119.	<i>irrespective</i>	*
120.	<i>apropos</i>	*
121.	<i>but</i>	*
122.	<i>albeit</i>	*
123.	<i>notwithstanding</i>	*
124.	<i>though</i>	*
125.	<i>whenever</i>	*
126.	<i>wherever</i>	*
127.	<i>once (temporal)</i>	*
128.	<i>once (TIMES)</i>	*
129.	<i>unless</i>	*
130.	<i>lest</i>	*
131.	<i>whereupon</i>	*
132.	<i>opposite</i>	Right <i>opposite</i> the club was a court containing about ten houses, built against the old city rampart. [BNC B22 661]
133.	<i>beyond</i>	I'll find it on the other side just right <i>beyond</i> my light. [COCA, SPOK NPR: Snap Judgement]
134.	<i>past</i>	We are going to play group, but we've gotta drive right <i>past</i> the letter box. [BNC KD1 395]
135.	<i>below</i>	She was right <i>below</i> her window now, gazing up those steep granite walls. [BNC H8X 37]
136.	<i>above</i>	Right <i>above</i> our heads was a huge red-lettered sign that said EXIT. [BNC ALH 1580]
137.	<i>round</i>	If you don't stop following me I'll send Jack right <i>round</i> to your place. [BNC ABX 649]
138.	<i>underneath</i>	... you can get your hand right <i>underneath</i> ours. [BNC KDM 9110]
139.	<i>beneath</i>	... and plentiful supplies of salt 'right <i>beneath</i> our feet. [BNC K9J 1030]
140.	<i>around</i>	My last day, I walk right <i>around</i> the island. [BNC APC 2254]
141.	<i>throughout</i>	Right <i>throughout</i> the year we will attend a number of bonfires every single month. [BNC HMA 834]
142.	<i>through</i>	ILLUSION runs right <i>through</i> the text and texture of The Mahabharata (C4). [BNC A9K 2]
143.	<i>within</i>	It was Law's achievement to keep the extreme right <i>within</i> the mainstream of the political system when it might have felt the need to abandon party politics altogether. [BNC EW1 388]
144.	<i>across</i>	As it was right <i>across</i> the road from college everyone was hanging out the window to see what was happening. [BNC A6E 1037]
145.	<i>inside</i>	My leg can go right <i>inside</i> . [BNC BNG 2222]



	The functional word	Right/straight modifiers
146.	<i>behind</i>	Gene was playing <u>right behind</u> us with Max Faulkner and Harry Bradshaw, I think, and he got his famous hole-in-one. [BNC ASA 1122]
147.	<i>alongside</i>	Suddenly, an obviously disused airfield appears, right <i>alongside</i> our track — and it isn't on our map! [BNC ECX 859]
148.	<i>under</i>	There was a movie going on right <i>under</i> his nose and he didn't even know. [BNC C86 771]
149.	N.S.E.W.	No, we were at my fiance's house with my parents right north of New Orleans. [COCA 2005]
150.	<i>instead</i>	*
151.	<i>minus</i>	*
152.	<i>versus</i>	*
153.	<i>per</i>	*
154.	<i>gone</i> (BrE)	*
155.	<i>since</i> (temporal)	*
156.	<i>since</i> (non-temporal)	*
157.	<i>as</i> (temporal)	*
158.	<i>as</i> (causative)	*
159.	<i>on</i> (locative)	*
160.	<i>on</i> (concerning)	*
161.	<i>on</i> (non-locative)	*
162.	<i>off</i> (locative)	He had lost control on the wet surface and spun <u>right off</u> the track. [BNC A7H 1062]
163.	<i>off</i> (non-locative)	It was a toe-curling moment, the sort of thing that turns the middle-classes <u>right off</u> . [BNC AHN 911]
164.	<i>outside</i> (locative)	He's <u>right outside</u> . [BNC CCW 217]
165.	<i>outside</i> (exception)	*
166.	<i>in</i> (locative)	I had to pull the tape out of the machine, interrupt the music <u>right in</u> the middle of the song. [BNC A0U 1417]
167.	<i>in</i> (non-locative)	*
168.	<i>that</i> (purposive)	*
169.	<i>that</i> (empty)	*
170.	<i>while</i> (temporal)	*
171.	<i>while</i> (concessive)	*
172.	<i>whilst</i> (temporal)	*
173.	<i>whilst</i> (concessive)	*
174.	<i>apart</i> ('away')	I mean, everything's got to work or this whole thing will fall <u>right apart</u> . [COCA, SPOK NBC_Today]
175.	<i>aside</i> ('away')	... because they will also sit <u>right aside</u> the other plans ... [COCA, SPOK PBS: PBS Newshour]
176.	<i>apart</i> (exception)	*
177.	<i>aside</i> (exception)	*
178.	<i>by</i> (non-locative)	*
179.	<i>by</i> (locative)	t stands <u>right by</u> the banks of the mighty Rhine and is close to the centre of Boppard itself. [BNC ED1 546]
180.	<i>at</i>	Images of parties and party leaders are <u>right at</u> the margin between perceptions and attitudes. [BNC A62 780]
181.	<i>about</i> (locative)	*
182.	<i>about</i> (concerning)	*
183.	<i>worth</i>	*
184.	<i>near</i>	That's <u>right near</u> the window yes and all the dust is coming in we've got to put up with it till Christmas. [BNC HMA 425]
185.	<i>close</i>	I stayed <u>right close</u> to him, and parried off attempts to hold me. [BNC B2E 1141]
186.	<i>far</i>	" Next door, but it's still <u>right far</u> ," Mabel said. [COCA 2008]

Property 17: Particle shift

	The functional word	Particle Shift
1.	<i>with</i>	*
2.	<i>for fear</i>	*
3.	<i>of</i>	*
4.	<i>in order</i>	*
5.	<i>on condition</i>	*
6.	<i>as to</i>	*
7.	<i>as for</i>	*
8.	<i>for all</i>	*
9.	<i>as soon as</i>	*
10.	<i>as long as</i>	*
11.	<i>in case</i>	*
12.	<i>in the event</i>	*
13.	<i>on the basis</i>	*
14.	<i>on the grounds</i>	*
15.	<i>to the effect</i>	*
16.	<i>all over</i>	*
17.	<i>in two minds</i>	*
18.	<i>here</i>	*
19.	<i>there</i>	*
20.	<i>now</i>	*
21.	<i>upstairs, downstairs</i>	*
22.	<i>uphill, downhill</i>	*
23.	<i>upstage, downstage</i>	*
24.	<i>upstream, downstream</i>	*
25.	<i>overseas, overboard, overhead, overland</i>	*
26.	<i>underfoot</i>	*
27.	<i>underground</i>	*
28.	<i>home</i>	*
29.	<i>outdoors, indoors</i>	*
30.	<i>back</i>	Goldberg, pushing <i>back</i> the typewriter and drawing the pad towards him, began again. [BNC A08 507] He pushed the pad aside, took out his handkerchief and wiped his face, stuffed the handkerchief <i>back</i> in his pocket and began to type again. [BNC A08 517]
31.	<i>backward(s), forward(s), upward(s), downward(s), inward(s), outward(s), eastward(s), northward(s), southward(s), westward(s), eastward(s), leftward(s), rightward(s), homeward(s), skyward(s), heavenward(s), seaward(s)</i>	They decided to bring <i>forward</i> the date of the next meeting. [Google Web] I'd like to bring the meeting <i>forward</i> . [Google Web]
32.	<i>abroad</i>	*
33.	<i>adrift</i>	*
34.	<i>aloft</i>	*
35.	<i>aground</i>	*
36.	<i>ashore</i>	*
37.	<i>contrary</i>	*
38.	<i>counter</i>	*
39.	<i>exclusive</i>	*
40.	<i>pursuant</i>	*
41.	<i>subsequent</i>	*
42.	<i>previous</i>	*
43.	<i>preparatory</i>	*
44.	<i>preliminary</i>	*



	The functional word	Particle Shift
45.	<i>prior</i>	*
46.	<i>adjacent</i>	*
47.	<i>unbeknown(st)</i>	*
48.	<i>further</i> (reference)	*
49.	<i>consequent</i>	*
50.	<i>due</i>	*
51.	<i>next</i>	*
52.	<i>away</i>	about 1,000 feet you should <u>put away</u> the maps, select a good field and check it for slopes and surface etc. [BNC A0H 1050] ... if they do send in dragoons with guns to <u>take the men away</u> — we are helpless, then, you know we are. [BNC A0N 1985]
53.	<i>out</i>	Work <i>out</i> double perspective, wrote Harsnet. [BNC A08 2219] They'll be here in a minute and I've got to <u>work things out</u> . [BNC BMS 3702]
54.	<i>abreast</i>	*
55.	<i>aboard</i>	*
56.	<i>down</i>	I put the receiver <i>down</i> and rested my head against the back of the kiosk. [BNC A0F 3217] I put down my suitcase and turned to say <u>goodbye</u> . [BNC A0F 1429]
57.	<i>up</i>	It is tempting to hang on to the launch, thinking that it will pick <i>up</i> speed ... [BNC A0H 733] 'I pick things <i>up</i> ,' she said. [BNC CJA 1128]
58.	<i>over</i>	Dear Harsnet, he wrote, tearing the sheet in his hurry to <u>turn over</u> the page. [BNC A08 1423] We now wait in suspense for the banker to <u>turn the cards over</u> . [BNC ARR 305]
59.	<i>along</i>	... what's the property read <u>along</u> the list. [BNC KPA 997]
60.	<i>ahead</i>	*
61.	<i>less</i> ('minus')	*
62.	<i>thanks</i>	*
63.	<i>owing</i>	*
64.	<i>according</i>	*
65.	<i>regarding</i>	*
66.	<i>from</i>	*
67.	<i>upon</i>	*
68.	<i>because</i>	*
69.	<i>although</i>	*
70.	<i>whereas</i>	*
71.	<i>via</i>	*
72.	<i>when</i>	*
73.	<i>where</i>	*
74.	<i>until</i>	*
75.	<i>after</i>	*
76.	<i>before</i>	*
77.	<i>whether</i>	*
78.	<i>without</i>	*
79.	<i>ago</i>	*
80.	<i>into</i>	*
81.	<i>onto</i>	*
82.	<i>between</i>	*
83.	<i>amid</i>	*
84.	<i>among</i>	*
85.	<i>against</i>	*
86.	<i>beside</i>	*
87.	<i>during</i>	*
88.	<i>come</i>	*
89.	<i>absent</i>	*
90.	<i>counting</i>	*
91.	<i>touching</i>	*
92.	<i>respecting</i>	*
93.	<i>concerning</i>	*
94.	<i>considering</i>	*
95.	<i>following</i>	*
96.	<i>failing</i>	*
97.	<i>barring</i>	*
98.	<i>excluding</i>	*
99.	<i>including</i>	*
100.	<i>pending</i>	*
101.	<i>excepting</i>	*
102.	<i>turning</i>	*
103.	<i>pertaining</i>	*



	The functional word	Particle Shift
104.	<i>bearing</i>	*
105.	<i>having</i>	*
106.	<i>given</i>	*
107.	<i>granted</i>	*
108.	<i>provided</i>	*
109.	<i>providing</i>	*
110.	<i>supposing</i>	*
111.	<i>assuming</i>	*
112.	<i>seeing</i>	*
113.	<i>allowing</i>	*
114.	<i>bar</i>	*
115.	<i>except</i>	*
116.	<i>if</i>	*
117.	<i>regardless</i>	*
118.	<i>besides</i>	*
119.	<i>irrespective</i>	*
120.	<i>apropos</i>	*
121.	<i>but</i>	*
122.	<i>albeit</i>	*
123.	<i>notwithstanding</i>	*
124.	<i>though</i>	*
125.	<i>whenever</i>	*
126.	<i>wherever</i>	*
127.	<i>once</i> (temporal)	*
128.	<i>once</i> (TIMES)	*
129.	<i>unless</i>	*
130.	<i>lest</i>	*
131.	<i>whereupon</i>	*
132.	<i>opposite</i>	*
133.	<i>beyond</i>	*
134.	<i>past</i>	*
135.	<i>below</i>	*
136.	<i>above</i>	*
137.	<i>round</i>	My tongue wouldn't get <i>round</i> the word or my mouth wouldn't open or something. [BNC A08 2900] ... he succeeded in <u>turning the company round</u> . [BNC A3S 396]
138.	<i>underneath</i>	*
139.	<i>beneath</i>	*
140.	<i>around</i>	On the other hand, when the family atmosphere becomes particularly strained or difficult, the counsellor should attempt to bring the discussion <i>around</i> to a more harmonious matter. [BNC CE1 840] Or to <u>turn the question around</u> , who could be found to marry him? [BNC ANR 326]
141.	<i>throughout</i>	*
142.	<i>through</i>	*
143.	<i>within</i>	*
144.	<i>across</i>	popular books and magazine articles about science can help to put <i>across</i> new developments, but even the most successful popular book is read by only a small proportion of the population. [BNC FYX 478] You have to have the ability to put that knowledge <i>across</i> . [BNC H7W 3143]
145.	<i>inside</i>	Put something <i>inside</i> the bag. [Google Web] You put something <i>inside</i> the parenthesis ... [Google Web]
146.	<i>behind</i>	*
147.	<i>alongside</i>	*
148.	<i>under</i>	then duck your head <i>under</i> ... [BNC BNK 1309]
149.	N.S.E.W.	*
150.	<i>instead</i>	*
151.	<i>minus</i>	*
152.	<i>versus</i>	*
153.	<i>per</i>	*
154.	<i>gone</i> (BrE)	*
155.	<i>since</i> (temporal)	*
156.	<i>since</i> (non-temporal)	*
157.	<i>as</i> (temporal)	*
158.	<i>as</i> (causative)	*
159.	<i>on</i> (locative)	I'll put <i>on</i> my shorts if you like. [BNC A0R 209] He had left the Phillips screwdriver in the spare room after we'd put the lid <i>on</i> . [BNC CES 1402]



	The functional word	Particle Shift
160.	on (concerning)	*
161.	on (non-locative)	Suddenly we realised it was eight o'clock and we rushed to the sitting room to put <i>on</i> the TV. [BNC A57 290] Put the kettle <i>on</i> , spooned coffee, rolled a cigarette, sat up in bed again and hoped the horrors had forgotten her address. [BNC A0L 3372]
162.	off (locative)	He leaned down from the saddle, <u>took off his glove</u> , held out his hand to the spokesman nearest him — Alex McLaggan (where was the Duke?). [BNC A0N 2321] I pushed him <i>on</i> to the bed and started to <u>take his shoes off</u> . [BNC ACK 849]
163.	off (non-locative)	But where they work, and age, and put <i>off</i> men. [BNC A05 1131]
164.	outside (locative)	I can't always manage to put the bin <i>outside</i> . [Google Web] Is correct that I put <i>outside</i> the dinner for the kids? [Google Web]
165.	outside (exception)	*
166.	in (locative)	Now this one is about erm how you prefer to <u>take in</u> information, how you prefer to understand things. [BNC G3Y 254] ... it certainly makes it a lot easier to learn things, <u>take information in</u> , ... [BNC JYN 685]
167.	in (non-locative)	All you have to do is to fill <i>in</i> the details, including your name and address and the amount you wish to give, and sign and date the document in front of a witness. [BNC A01 242] You just fill a form <i>in</i> . [BNC G4F 168]
168.	that (purposive)	*
169.	that (empty)	*
170.	while (temporal)	*
171.	while (concessive)	*
172.	whilst (temporal)	*
173.	whilst (concessive)	*
174.	apart ('away')	*
175.	aside ('away')	*
176.	apart (exception)	*
177.	aside (exception)	*
178.	by (non-locative)	*
179.	by (locative)	*
180.	at	*
181.	about (locative)	*
182.	about (concerning)	*
183.	worth	*
184.	near	*
185.	close	*
186.	far	*

Property 18: As predicate complement in raising constructions

	The functional word	Predicate complement in raising constructions
1.	<i>with</i>	It is <i>with</i> great regret that I see so many students labouring day after day in the Academy ... [BNC A04 349]
2.	<i>for fear</i>	... my lack of close affection could have been <i>for fear</i> that this baby would die as well. The first year was so fragile that [COCA 2008]
3.	<i>of</i>	The sky is <i>of</i> the blue of an English summer day, with large, but not threatening, clouds of a silvery whiteness. [BNC A04 801]
4.	<i>in order</i>	This was <i>in order</i> to 'convince him of his misery and the necessity of true repentance and reformation'. [BNC ALK 324]
5.	<i>on condition</i>	It was <i>on condition</i> no one ever reminding them they were actually living there. [BNC ABS 2476]
6.	<i>as to</i>	*
7.	<i>as for</i>	*
8.	<i>for all</i>	*
9.	<i>as soon as</i>	*
10.	<i>as long as</i>	*
11.	<i>in case</i>	It was <i>in case</i> I had a 'hypo', she recalls. [BNC A70 1739]
12.	<i>in the event</i>	but I wondered how adjustable they might be <i>in the event</i> of a change in wind or weather. [COCA 1999]
13.	<i>on the basis</i>	The offer is <i>on the basis</i> of one new share for one old at 128p per share. [BNC A2V 77]
14.	<i>on the grounds</i>	This is <i>on the grounds</i> that there are no high-temperature incineration facilities in sub-Saharan Africa and no plans to build any. [BNC HH3 13824]
15.	<i>to the effect</i>	The authors' intuitions are <i>to the effect</i> that in (12), a plural continuation would be preferred, however. [BNC B2X 98]
16.	<i>all over</i>	They should be <i>all over</i> the place — especially where least expected — halfway down a leg, on a collar, cuff or elbow for instance. [BNC AAV 877]
17.	<i>in two minds</i>	He is <i>in two minds</i> . [BNC A05 690]
18.	<i>here</i>	Yes, he's right <i>here</i> . [BNC AE0 1155]
19.	<i>there</i>	It is not so long till some bushes are <i>there</i> . [BNC A0D 243]
20.	<i>now</i>	Engels is saying that the family and marriage have not always been as they are <i>now</i> . [BNC A6S 1159]
21.	<i>upstairs, downstairs</i>	They're <i>upstairs</i> . [BNC BMS 3588]
22.	<i>uphill, downhill</i>	... since it was <i>uphill</i> for most of the way and she didn't want to arrive hot and sticky, she would take a taxi up, and walk down. [BNC JYF 460]
23.	<i>upstage, downstage</i>	You know in the dinner party scene, when I'm <i>downstage</i> doing my incest speech ... 7' [BNC H92 1296]
24.	<i>upstream, downstream</i>	The barrage itself will be <i>downstream</i> from the Teesdale site at Blue House Point. [BNC K51 468]
25.	<i>overseas, overboard, overhead, overland</i>	When you did not phone in answer to my letter, I told him that you were <i>overseas</i> . [BNC HGD 3682]
26.	<i>underfoot</i>	I was aiming to be far enough away that I wouldn't be <i>underfoot</i> , but close enough that I might overhear what was going on. [COCA, FIC Bk:DuckHallsMegLangslow]
27.	<i>underground</i>	Its full size had not been appreciated, since most of it was <i>underground</i> . [BNC AHA 245]
28.	<i>home</i>	'It's <i>home</i> , though.' [BNC A0F 2789]
29.	<i>outdoors, indoors</i>	'Don't need any, I'm <i>outdoors</i> all day!' [BNC CEB 2541]
30.	<i>back</i>	'She'll be <i>back</i> .' [BNC A0F 2539]
31.	<i>backward(s), forward(s), upward(s), downward(s), inward(s), outward(s), eastward(s), northward(s), southward(s), westward(s), eastward(s), leftward(s), rightward(s), homeward(s), skyward(s), heavenward(s), seaward(s)</i>	Poor Sam had been backwards at coming <i>forwards</i> , she told herself. [BNC C98 1959]
32.	<i>abroad</i>	Few had been <i>abroad</i> , despite the frequent German and Hungarian names displayed Texas-fashion outside their houses. [BNC ABW 415]
33.	<i>adrift</i>	The seamen are <i>adrift</i> in lifeboats, seventeen hundred miles off the Falkland Islands. [BNC K21 100]
34.	<i>aloft</i>	As soon as they were <i>aloft</i> in the rotor, Roirbak called Acropolis Park. [BNC AD9 3203]



	The functional word	Predicate complement in raising constructions
35.	<i>aground</i>	She was <i>aground</i> then, but there should be enough water to float her now. [BNC GW3 1431]
36.	<i>ashore</i>	I've been <i>ashore</i> , enjoying a short break to which I was perfectly entitled,' she flung back at him. [BNC JXW 3571]
37.	<i>contrary</i>	This was <i>contrary</i> to the opinion of the world and society which thought of him as a boffin. [BNC A68 1813]
38.	<i>counter</i>	There are fears that the proposal could be <i>counter</i> to the Cleveland structure plan, which sets out guidelines for future development. [BNC K4S 1206]
39.	<i>exclusive</i>	These are <i>exclusive</i> to Gardener readers. [BNC ACY 38]
40.	<i>pursuant</i>	Where the appointment is <i>pursuant</i> to a provision in the debenture ... [BNC GVG 891]
41.	<i>subsequent</i>	Theory is <i>subsequent</i> to the collection of data or facts about the world ... [BNC HPU 181]
42.	<i>previous</i>	This is <i>previous</i> to 2011, well into his presidency ... [COCA, SPOK NPR: Fresh Air]
43.	<i>preparatory</i>	The conference was <i>preparatory</i> to the second world climate conference in November 1990 [see p. 37874]. [BNC HL7 5063]
44.	<i>preliminary</i>	pre-notice investigation " letter or similar term reflective of the fact that the matter is <i>preliminary</i> to issuance of an official notice under the suspension or debarment rules. [COCA, ACAD Public Contract Law Journal]
45.	<i>prior</i>	Well this was <i>prior</i> to January 1st, when the Natural Death Act became law. [BNC ASK 1123]
46.	<i>adjacent</i>	These are <i>adjacent</i> to the Globe site. [BNC A59 736]
47.	<i>unbeknown(st)</i>	It may be <i>unbeknownst</i> to her mom and her sister, [COCA, SPOK CNN Grace]
48.	<i>further</i> (reference)	*
49.	<i>consequent</i>	Sometimes it has seemed to me that the second kind of pleasure is <i>consequent</i> on the first ... [COCA, MAG NewStatesman]
50.	<i>due</i>	This is <i>due</i> to increased demand on funds. [BNC A10 555]
51.	<i>next</i>	It is <i>next</i> to the showers. [BNC A59 141]
52.	<i>away</i>	While I was <i>away</i> it must have rained. [BNC A0R 2991]
53.	<i>out</i>	I was furious, I was <i>out</i> of my mind. [BNC A06 929]
54.	<i>abreast</i>	He was <i>abreast</i> with the lorry when I saw the oncoming small black car overtaking on the other side, and overtaking fast. [BNC CK0 1583]
55.	<i>aboard</i>	Adams was <i>aboard</i> when Party Politics scored his first victory in a two-and-a-half mile novice chase at Warwick in Feb 1990. [BNC AHU 1568]
56.	<i>down</i>	I was <i>down</i> the market every day with my shopper ... [BNC A0L 2102]
57.	<i>up</i>	But not before the sun is <i>up</i> . [BNC A0N 491]
58.	<i>over</i>	As this is <i>over</i> the inheritance tax threshold, it would bring a tax bill of £4,800. [BNC A01 437]
59.	<i>along</i>	He'll be <i>along</i> in a minute. [BNC A6T 1208]
60.	<i>ahead</i>	A telegraph pole was <i>ahead</i> . [BNC A68 784]
61.	<i>less</i> ('minus')	The chance of getting infected from a pint of blood is <i>less</i> than 1 in a million. [BNC A01 26]
62.	<i>thanks</i>	It was <i>thanks</i> to you all that I humiliated myself at the Harrogate Trade Show. [BNC CCP 898]
63.	<i>owing</i>	It is <i>owing</i> to that dynamic force, and that remarkable personality, that the Liberal Party, to which he formerly belonged, has been smashed to pieces ... [BNC EFN 394]
64.	<i>according</i>	That is <i>according</i> to Kate. [BNC A61 1734]
65.	<i>regarding</i>	But the main use of this act in relation to present concerns is <i>regarding</i> exploitation of monopoly situations. [BNC FRN 1038]
66.	<i>from</i>	The first speech is <i>from</i> Shakespeare and it's taken from the Chorus in Henry ... [BNC A06 2103]
67.	<i>upon</i>	A playful puppyish mood is <i>upon</i> you ... [BNC ACM 698]
68.	<i>because</i>	'It's <i>because</i> my hair's longer. [BNC A0F 3101]
69.	<i>although</i>	*
70.	<i>whereas</i>	*
71.	<i>via</i>	Most of the run is <i>via</i> motorway and covered at an average speed of 50–60mph. [BNC AN2 1042]
72.	<i>when</i>	This was <i>when</i> Chris Spedding, the guitarist, started hanging out in the shop. [BNC A6E 668]
73.	<i>where</i>	Again, this is <i>where</i> sculpture is closely aligned to social and political history. [BNC A04 899]
74.	<i>until</i>	That is <i>until</i> the BBC came along. [BNC: A6W 304]
75.	<i>after</i>	It was <i>after</i> ten o'clock. [BNC A0R 2405]
76.	<i>before</i>	That is <i>before</i> the fête begins. [BNC A18 1191]
77.	<i>whether</i>	But the main area of controversy is <i>whether</i> simply obtaining unauthorised access to a computer should be a crime. [BNC A3G 511]
78.	<i>without</i>	I was <i>without</i> the religious sense of my family. [BNC A05 183]
79.	<i>ago</i>	That was ages <i>ago</i> — I hope I ain't forgot how to ride one. [BNC A74 415]
80.	<i>into</i>	But it is <i>into</i> the mouth of one of Darcy's travelling companions that the heart of Keneally's emotional response to the Eritreans is put. [BNC A36 114]
81.	<i>onto</i>	It is usually staffed by Macintosh enthusiasts who think that they are <i>onto</i> a good thing and often appear to enjoy a remarkably short life span ... [BNC G00 428]
82.	<i>between</i>	... it is probable that there are <i>between</i> 40–60,000 people actually infected. [BNC A00 20]
83.	<i>amid</i>	Men should be walking about on Earth in a state of intoxication and delight, yet here we are <i>amid</i> these real riches and most people are miserable and peevish. [BNC B1F 1010]
84.	<i>among</i>	He is <i>among</i> the least ego-bound of book-writers ... [BNC A05 1525]
85.	<i>against</i>	He is <i>against</i> racism and sexism, but is capable of reflecting: 'He was in love with Alison Houston. [BNC A05 1610]



	The functional word	Predicate complement in raising constructions
86.	<i>beside</i>	Lee was <i>beside</i> him again. [BNC ABX 3039]
87.	<i>during</i>	It is <i>during</i> this time that torture most commonly occurs. [BNC A03 237]
88.	<i>come</i>	*
89.	<i>absent</i>	*
90.	<i>counting</i>	We shall never know whether he was <i>counting</i> Mark Twain. [BNC ACS 1110]
91.	<i>touching</i>	I recently did a workshop at the International Theraplay® conference where the topic was <i>touching</i> sexually abused children. [Google Web]
92.	<i>respecting</i>	... but in general governments at federal and state level appear to <i>be respecting</i> the guarantees of freedom of expression. [BNC CDU 1567]
93.	<i>concerning</i>	It is <i>concerning</i> PAs and speakers: they just cost too much. [BNC C9J 2324]
94.	<i>considering</i>	Mr Beeton is <i>considering</i> a range of options to embellish their presentation without substituting fiction for reality. [BNC A21 28]
95.	<i>following</i>	Provided no one was <i>following</i> me. [BNC A0U 1938]
96.	<i>failing</i>	They were <i>failing</i> to recognize or were positively discounting the rights of those dissenting from their particular views of public order, and subjecting that dissent to the full coercion of the state. [BNC A07 1226]
97.	<i>barring</i>	Alexei was <i>barring</i> his progress along the passageway and Rostov sighed inwardly. [BNC FSE 520]
98.	<i>excluding</i>	I am <i>excluding</i> the present proceedings from consideration here, since they are entirely untypical of what I do. [BNC J17 2831]
99.	<i>including</i>	'Yes, it will be <i>including</i> the searchlights.' [BNC B0U 2468]
100.	<i>pending</i>	The case is <i>pending</i> . [BNC EBU 479]
101.	<i>excepting</i>	I know they're <i>excepting</i> patients for checks there ... [BNC KE4 1406]
102.	<i>turning</i>	I shall be <i>turning</i> to Lawrence shortly. [BNC A6D 421]
103.	<i>pertaining</i>	Whether it is <i>pertaining</i> to Afghanistan or Pakistan, we have a common threat. [COCA, SPOK Fox_Susteren]
104.	<i>bearing</i>	And we should always sort of be <i>bearing</i> in mind how we were representing that entity or what we were doing for that ... [COCA 2016]
105.	<i>having</i>	If you are <i>having</i> a mains garden lighting circuit installed, it makes sense to have power points suitable for power tools such as mowers and hedge trimmers put in at the time. [BNC A16 1407]
106.	<i>given</i>	*
107.	<i>granted</i>	*
108.	<i>provided</i>	This is <i>provided</i> that the product returned is received back to us within the 14 day returns period or is faulty. [Google Web]
109.	<i>providing</i>	What services will you be <i>providing</i> that your room is not getting now? [COCA 2003]
110.	<i>supposing</i>	we're <i>supposing</i> that a spaceplane is worth building in the first place. [COCA 1991]
111.	<i>assuming</i>	what I'm saying is <i>assuming</i> that that's not just a random laser beam [COCA 2010]
112.	<i>seeing</i>	And we're <i>seeing</i> that now play out both on the campaign trail and also in this survey. [COCA 2016]
113.	<i>allowing</i>	For many people, the biggest challenge in getting in sync with these rhythms is <i>allowing</i> that sync to happen rather than forcing it. [COCA 1996]
114.	<i>bar</i>	*
115.	<i>except</i>	Everyone, this is <i>except</i> Hannah. [BNC BN6 530]
116.	<i>if</i>	Often, the only cause of damage to the glider is <i>if</i> the wings or fuselage break loose. [BNC A0H 321] in Huddleston, this case is not possible. See Huddleston (2002: 974)
117.	<i>regardless</i>	This was <i>regardless</i> of the unpopularity or obnoxiousness of the views that were being expressed — and protected. [BNC ASB 1323]
118.	<i>besides</i>	... he could have lost his licence but erm that's <i>besides</i> the point. [BNC HF2 29]
119.	<i>irrespective</i>	This is <i>irrespective</i> of the value of any counterclaim (ibid). [BNC J6U 1070]
120.	<i>apropos</i>	I don't. It is <i>apropos</i> for what we're doing. [COCA, SPOK Fox Live Event]
121.	<i>but</i>	*
122.	<i>albeit</i>	*
123.	<i>notwithstanding</i>	This was <i>notwithstanding</i> that he had not found the relationship between the bank and the husband to be one of principal and agent. [BNC FD3 645]
124.	<i>though</i>	*
125.	<i>whenever</i>	... that is <i>whenever</i> CB and PB appear. [BNC CGS 1832]
126.	<i>wherever</i>	This process should be <i>wherever</i> possible part of a systematic analysis of diagnostic system requirements. [BNC BP2 584]
127.	<i>once</i> (temporal)	Trouble is <i>once</i> a directive hits Whitehall beviies of officials are stirred into action ... [BNC JSF 459]
128.	<i>once</i> (times)	Oh I think it was <i>once</i> a week ... [BNC HEC 31]
129.	<i>unless</i>	That is <i>unless</i> it's sold to the sort of person who blasts half of his land away to quarry gravel for motorways, like someone I can think of on the west coast. [BNC AS3 412]
130.	<i>lest</i>	The reason for placing them together was <i>lest</i> Loraine should try to harm herself. [COCA 1990]
131.	<i>whereupon</i>	*
132.	<i>opposite</i>	So that's <i>opposite</i> the angle that we're working with. [BNC FMJ 55]
133.	<i>beyond</i>	The long-term psychic damage Pound underwent is <i>beyond</i> calculation. [BNC A1B 223]
134.	<i>past</i>	It is <i>past</i> midnight in Tegucigalpa, and it's time to go home. [BNC A95 186]



	The functional word	Predicate complement in raising constructions
135.	<i>below</i>	Remove leaves that will be <i>below</i> water level when flowers are arranged. [BNC A70 1955]
136.	<i>above</i>	It was <i>above</i> all the white middle class who benefited from a free health service, earnings-related pensions, and the growth of larger secondary schools. [BNC A66 425]
137.	<i>round</i>	Soon I was <i>round</i> the corner again and on my way back to the station. [BNC A0F 1354]
138.	<i>underneath</i>	The rats are <i>underneath</i> the piles. [BNC A6B 170]
139.	<i>beneath</i>	All of your body is <i>beneath</i> the water, but for your face. [BNC AD9 1710]
140.	<i>around</i>	'Oh, it's been <i>around</i> the common room for some time now.' [BNC A0F 221]
141.	<i>throughout</i>	Suddenly Anne thought of the kitchen as it had been <i>throughout</i> her childhood, a warm, secure and loving haven. [BNC G16 2068]
142.	<i>through</i>	It was <i>through</i> a family connection, I think ... [BNC A0F 308]
143.	<i>within</i>	The attack was <i>within</i> the context of a speech largely praising the Roman catholic church in Ireland. [BNC A07 1291]
144.	<i>across</i>	It's <i>across</i> the street in the Donnell Library. [BNC A6C 1723]
145.	<i>inside</i>	'I've never been <i>inside</i> the local police station,' said Ethel. [BNC A0D 2381]
146.	<i>behind</i>	Unfortunately, they were <i>behind</i> schedule and I had to make do with a curry-house scene. [BNC A2G 110]
147.	<i>alongside</i>	If trees are <i>alongside</i> a road they are likely to conceal telephone or power wires, making it dangerous to go between them. [BNC A0H 1176]
148.	<i>under</i>	And when the Irish Free State did emerge in 1921, practically the entire school system was <i>under</i> the control of the churches. [BNC A07 1311]
149.	N.S.E.W.	When we were <i>north</i> of the border recently for the Scottish Music Show, before I'd had time to look round myself, people were rushing over to describe a monster the like of which they'd never before seen. [BNC C9N 1128]
150.	<i>instead</i>	The new privatised inspectors will be <i>instead</i> of public service inspectors. [BNC HHW 2445]
151.	<i>minus</i>	Four X plus one is <i>minus</i> three. [BNC FYA 1677]
152.	<i>versus</i>	Typical half-wave reduction potentials for 1,2 compounds are <i>versus</i> the standard calomel electrode (SCE) while those for the 1,3-isomers are 0.2V. [BNC ALW 2304]
153.	<i>per</i>	Prices are <i>per</i> person in cabin one way. [BNC EBN 210]
154.	<i>gone</i> (BrE)	It was <i>gone</i> midnight, cold and autumnal, and they shivered in their denim jackets. [BNC AT4 1350]
155.	<i>since</i> (temporal)	... it was <i>since</i> we had had a bath. [BNC A61 1691]
156.	<i>since</i> (non-temporal)	*
157.	<i>as</i> (temporal)	*
158.	<i>as</i> (causative)	*
159.	<i>on</i> (locative)	I knew I was <i>on</i> the right track when I felt that thrill of pleasure at placing object, not painting it. [BNC A08 2528]
160.	<i>on</i> (concerning)	Some of the veterans were <i>on</i> the point of giving tongue but young Donald McCulloch was on his feet and moving into the middle of the ring, he was full of himself, sparkling with mischief but with an undertow of ardour. [BNC A0N 1314]
161.	<i>on</i> (non-locative)	As before, the news was <i>on</i> . [BNC A0R 1701]
162.	<i>off</i> (locative)	I'm <i>off</i> to Boulogne-sur-Mer with Rosita, Keith, Brian and Sue. [BNC A05 880]
163.	<i>off</i> (non-locative)	The problem of the cut-off water supply — it had <i>been off</i> since eight that morning — had made it much worse. [BNC A0D 838]
164.	<i>outside</i> (locative)	Once they were <i>outside</i> , he pointed across the level land towards the loch. [BNC A0N 1689]
165.	<i>outside</i> (exception)	*
166.	<i>in</i> (locative)	It is <i>in</i> this arena that some of the fiercest intellectual fighting about art is taking place, though the contests range wider than the visual arts to politics and economics. [BNC A04 686]
167.	<i>in</i> (non-locative)	And their confidence is <i>in</i> that process rather than in any particular answer. [COCA, ACAD Humanist]
168.	<i>that</i> (purposive)	*
169.	<i>that</i> (empty)	A difficulty is <i>that</i> psychology has narrow terms of reference which can give only a few useful results, for example on the question of illusion. [BNC A04 1509]
170.	<i>while</i> (temporal)	This was <i>while</i> you were still at school? [BNC FXY 160]
171.	<i>while</i> (concessive)	*
172.	<i>whilst</i> (temporal)	In the figure the curvature in the section shown is <i>whilst</i> the orthogonal line in the surface (a circle around the axis of symmetry) has curvature . [BNC H8K 496]
173.	<i>whilst</i> (concessive)	*
174.	<i>apart</i> ('away')	And always, when we were <i>apart</i> , I kept bringing you beside me in my imagination, in the poems I was writing all alone ... [BNC AC6 1031]
175.	<i>aside</i> ('away')	*
176.	<i>apart</i> (exception)	That is <i>apart</i> from the massive appearance money ADT has put up. [BNC AJY 340]
177.	<i>aside</i> (exception)	*
178.	<i>by</i> (non-locative)	save that where the arrest is <i>by</i> a private person ... [BNC FRA 547]
179.	<i>by</i> (locative)	Guerrillas is set in an imaginary Caribbean country, whose capital city is <i>by</i> the sea. [BNC A05 22]
180.	<i>at</i>	'This was <i>at</i> the church just down the road from here?' [BNC A0F 1859]
181.	<i>about</i> (locative)	The locativewas <i>about</i> the room. [Q]
182.	<i>about</i> (concerning)	It is <i>about</i> personal experience of particular brands as much as looking for the numbers. [BNC A0C 931]



	The functional word	Predicate complement in raising constructions
183.	<i>worth</i>	Let's say that your estate <u>is <i>worth</i></u> £140,000 ... [BNC A01 436]
184.	<i>near</i>	It <u>was <i>near</i></u> midnight. [BNC A0L 574]
185.	<i>close</i>	She <u>was <i>close</i></u> to tears now. [BNC A0D 2714]
186.	<i>far</i>	He <u>is <i>far from</i></u> being one of the outer world, but in reading his work we constantly feel the influence upon him of his reading of the worst English poets. [BNC A1B 387]

Property 19: As predicate complement in resultative constructions

	The functional word	Predicate complement in resultative constructions
1.	<i>with</i>	Today we want to leave you <i>with</i> an unusual show of unity. [COCA, SPOK CBS: Face The Nation]
2.	<i>for fear</i>	*
3.	<i>of</i>	*
4.	<i>in order</i>	*
5.	<i>on condition</i>	*
6.	<i>as to</i>	*
7.	<i>as for</i>	*
8.	<i>for all</i>	*
9.	<i>as soon as</i>	*
10.	<i>as long as</i>	*
11.	<i>in case</i>	*
12.	<i>in the event</i>	*
13.	<i>on the basis</i>	*
14.	<i>on the grounds</i>	*
15.	<i>to the effect</i>	*
16.	<i>all over</i>	The order grew immensely wealthy and place names <i>all over</i> the country still remind us of lands that they once owned. [BNC B0G 346]
17.	<i>in two minds</i>	Barlow confessed: 'Mo called for the ball and put me <i>in two minds</i> . [BNC CBG 9391]
18.	<i>here</i>	Let's put these <i>here</i> . [BNC: BNG 1254]
19.	<i>there</i>	A only relates to B because I have put them <i>there</i> . [BNC: A08 1322]
20.	<i>now</i>	*
21.	<i>upstairs, downstairs</i>	Let me put these things <i>upstairs</i> .' [BNC CCM 36]
22.	<i>uphill, downhill</i>	The super-fast sit-skiers will make it <i>downhill</i> in record time on a specially molded seat atop ... [COCA, MAG Ms]
23.	<i>upstage, downstage</i>	He was released to Roy. Roy picked him up, took him <i>downstage</i> ... [COCA, SPOK CNN_King]
24.	<i>upstream, downstream</i>	Genomic DNA was amplified using the polymerase chain reaction with primers to detect intragenic RsaI and SspI restriction enzyme polymorphic sites and a CA repeat found 30–70 Kb <i>downstream</i> from the DP2.5 APC gene. [BNC HWT 1028]
25.	<i>overseas, overboard, overhead, overland</i>	They will also place technical features <i>overseas</i> on a nationally exclusive basis. [BNC EX6 394]
26.	<i>underfoot</i>	My sisters were all much older and hated to have me <i>underfoot</i> . [COCA, FIC NewYorker]
27.	<i>underground</i>	Here the question is not merely one of sensitivity but also of the enormous additional cost of preserving amenities by placing cables <i>underground</i> . [BNC J16 1394]
28.	<i>home</i>	'I'm not taking him <i>home</i> ,' said Lee. [BNC ABX 3286]
29.	<i>outdoors, indoors</i>	Grizedale gave me a real opportunity to put my work <i>outdoors</i> . [BNC CHH 1598]
30.	<i>back</i>	Or should I put them <i>back</i> where they were?' [BNC A0R 805]
31.	<i>backward(s), forward(s), upward(s), downward(s), inward(s), outward(s), eastward(s), northward(s), southward(s), westward(s), eastward(s), leftward(s), rightward(s), homeward(s), skyward(s), heavenward(s), seaward(s)</i>	The sight of the old man's tremors threw me <i>backward</i> into the afternoon. [COCA, FIC Bk:ImmaculateHeart]
32.	<i>abroad</i>	I think Nigel's parents were wrong to take him <i>abroad</i> . [BNC ALH 554]
33.	<i>adrift</i>	The oil lamp had guttered out, leaving me <i>adrift</i> in the darkness. [COCA, FIC FantasySciFi]
34.	<i>aloft</i>	Which brings us to one vital and final point on the matter of taking our fauna <i>aloft</i> and then casting them off to the winds not knowing exactly where they are going to land. [BNC CA1 1227]
35.	<i>aground</i>	til she put herself <i>aground</i> on a reef of discarded beef and pig bones! [COCA, FIC Bk:KingsEmperors]
36.	<i>ashore</i>	'Yet you wanted to put me <i>ashore</i> .' [BNC H7W 4422]
37.	<i>contrary</i>	Until the seventeenth century the courts would declare Acts of Parliament void if they considered them <i>contrary</i> to natural law.. [BNC EVK 189]
38.	<i>counter</i>	Has she found information <i>counter</i> to the evidence presented by the prosecution? [COCA, FIC FantasySciFi]



	The functional word	Predicate complement in resultative constructions
39.	<i>exclusive</i>	We fund it <i>exclusive</i> to our group. [BNC C9X 951]
40.	<i>pursuant</i>	Louis granted the Collector the ability to make rules <i>pursuant</i> to the City Code under the title ... [COCA, ACAD The Tax Lawyer]
41.	<i>subsequent</i>	to say the notes carried all of this still further, by treating births <i>subsequent</i> to the first ... [COCA, FIC Analog]
42.	<i>previous</i>	had any of these prolific fish survived from the spasmodic efforts to acclimatize them <i>previous</i> to 1900. [COCA, ACAD MarineFish]
43.	<i>preparatory</i>	... drew primarily to capture life and stimulate his imagination, not just to make sketches <i>preparatory</i> to painting. [COCA, MAG USAToday]
44.	<i>preliminary</i>	I found it <i>preliminary</i> to the course. [BNC DCC 1673]
45.	<i>prior</i>	If confirmed, Thomas would take office <i>prior</i> to the start of the Supreme Court's autumn session on Oct. 7. [BNC HL9 594]
46.	<i>adjacent</i>	Another different vantage point is to position oneself <i>adjacent</i> to the shooter at the side of the lane, ... [COCA, ACAD PSAJournal]
47.	<i>unbeknown(st)</i>	*
48.	<i>further</i> (reference)	*
49.	<i>consequent</i>	*
50.	<i>due</i>	*
51.	<i>next</i>	I believe in putting common stuff <i>next</i> to rarer things. [BNC A7D 598]
52.	<i>away</i>	Someone could have put it <i>away</i> or be using it to sweep up a broken wine glass. [BNC A0R 2866]
53.	<i>out</i>	The very conservative firebrand, religious right candidate is the one who made it <i>out of</i> the primary in Alanama. [COCA SPOK PBS Newshour]
54.	<i>abreast</i>	Fortunately the Yair ford was a wide one, so many horsemen could take it <i>abreast</i> . [BNC CD8 1719]
55.	<i>aboard</i>	Put my baggage <i>aboard</i> . [BNC ACE 3633]
56.	<i>down</i>	Put it <i>down</i> here. [BNC A0D 2632]
57.	<i>up</i>	'When we put our heads <i>up</i> , we saw the fires, and the swords slicing away. [BNC A0N 270]
58.	<i>over</i>	He put his hands <i>over</i> the receiver. [BNC A0F 755]
59.	<i>along</i>	He used to clean all our shoes and put them <i>along</i> the floor. [BNC AP7 1694]
60.	<i>ahead</i>	But while Mills put them <i>ahead</i> , the game was not safe until Tommy Wright's clincher three minutes from time. [BNC AK6 844]
61.	<i>less</i> ('minus')	Because I am a Christian, I have found the break <i>less</i> frightening, since I believe that my parents are now in the presence of the same God who is with me. [BNC BLW 987]
62.	<i>thanks</i>	*
63.	<i>owing</i>	*
64.	<i>according</i>	*
65.	<i>regarding</i>	*
66.	<i>from</i>	She tried to put it <i>from</i> her mind ... [COCA, FIC Bk:MaineNovel]
67.	<i>upon</i>	Most neighbourhood police place the emphasis <i>upon</i> community service and informal contact ... [BNC A5Y 1569]
68.	<i>because</i>	*
69.	<i>although</i>	*
70.	<i>whereas</i>	*
71.	<i>via</i>	can't climb the outside wall of a skyscraper, it could probably make it <i>via</i> the stairways. [COCA, MAG Smithsonian]
72.	<i>when</i>	*
73.	<i>where</i>	*
74.	<i>until</i>	*
75.	<i>after</i>	... one cannot just put any sentence <i>after</i> another and hope that it will mean something ... [BNC F9W 9]
76.	<i>before</i>	... and some intentionally put profit <i>before</i> safety. [BNC A1X 15]
77.	<i>whether</i>	*
78.	<i>without</i>	The thing is, he saw it <i>without</i> an MOT and that lad wanted it ... [BNC KCY 651]
79.	<i>ago</i>	*
80.	<i>into</i>	He rises and puts the pieces <i>into</i> the drawer of the chest of drawers. [BNC A06 1082]
81.	<i>onto</i>	The 'too fast' signal should not be given until the glider is well up into the climb and putting a load <i>onto</i> the cable. [BNC A0H 614]
82.	<i>between</i>	Put them <i>between</i> shrubs and herbaceous plants in beds and borders. [BNC A0G 411]
83.	<i>amid</i>	Nor was he the only one to see hope <i>amid</i> chaos. [BNC CRB 1912]
84.	<i>among</i>	Keats placed him <i>among</i> the stars, where Keats himself, for similar reasons, was to be placed by Shelley. [BNC A05 579]
85.	<i>against</i>	Yes, he went out, put the ladder <i>against</i> the wall briefly to leave traces, threw a bit of mud through the window, and the key, and scattered more mud around the rose bed. [BNC A0D 2475]
86.	<i>beside</i>	garden he eventually found her <i>beside</i> the old hanging tree. [BNC AMB 50]
87.	<i>during</i>	*
88.	<i>come</i>	*
89.	<i>absent</i>	*



	The functional word	Predicate complement in resultative constructions
90.	<i>counting</i>	*
91.	<i>touching</i>	*
92.	<i>respecting</i>	*
93.	<i>concerning</i>	*
94.	<i>considering</i>	*
95.	<i>following</i>	*
96.	<i>failing</i>	*
97.	<i>barring</i>	*
98.	<i>excluding</i>	*
99.	<i>including</i>	*
100.	<i>pending</i>	*
101.	<i>excepting</i>	*
102.	<i>turning</i>	*
103.	<i>pertaining</i>	*
104.	<i>bearing</i>	*
105.	<i>having</i>	*
106.	<i>given</i>	*
107.	<i>granted</i>	*
108.	<i>provided</i>	*
109.	<i>providing</i>	*
110.	<i>supposing</i>	*
111.	<i>assuming</i>	*
112.	<i>seeing</i>	*
113.	<i>allowing</i>	*
114.	<i>bar</i>	*
115.	<i>except</i>	*
116.	<i>if</i>	*
117.	<i>regardless</i>	*
118.	<i>besides</i>	*
119.	<i>irrespective</i>	*
120.	<i>apropos</i>	*
121.	<i>but</i>	*
122.	<i>albeit</i>	*
123.	<i>notwithstanding</i>	*
124.	<i>though</i>	*
125.	<i>whenever</i>	*
126.	<i>wherever</i>	*
127.	<i>once (temporal)</i>	*
128.	<i>once (TIMES)</i>	*
129.	<i>unless</i>	*
130.	<i>lest</i>	*
131.	<i>whereupon</i>	*
132.	<i>opposite</i>	As each reader received a book he put the date <i>opposite</i> his name, followed by the date on which he finished it, before sending it on to the next person on the list. [BNC ARX 292]
133.	<i>beyond</i>	But the effort proved too much to sustain and Reykjavik scored the next 13 points to put the issue <i>beyond</i> doubt. [BNC A2S 427]
134.	<i>past</i>	I wouldn't put it <i>past</i> you! [BNC ACB 804]
135.	<i>below</i>	I found a niche <i>below</i> a roof to one side and sat and ruminated while the sun rose and filled the upper valley with light. [BNC ECG 637]
136.	<i>above</i>	... this puts her <i>above</i> suspicion. [BNC A1B 817]
137.	<i>round</i>	Dot put her arm <i>round</i> her mother's neck and hugged to show she was still awake and listening. [BNC AC5 94]
138.	<i>underneath</i>	I'd put it <i>underneath</i> the drawer in my mum and dad's bedroom at night. [BNC KCE 5012]
139.	<i>beneath</i>	you lose it or put it <i>beneath</i> glass. [BNC APC 1634]
140.	<i>around</i>	I'll put the word <i>around</i> and see if anybody can come up with something. [BNC A0F 3022]
141.	<i>throughout</i>	The strong winds took their toll <i>throughout</i> the day with most competitors finding themselves going overboard at some point during the races, which came under the control of Bolton Sailing Club officials. [BNC HPC 442]
142.	<i>through</i>	And I didn't know whether I could put them <i>through</i> another year of what we had already gone through. [COCA, SPOK NBC: Dateline NBC]
143.	<i>within</i>	My purpose in what follows is to try to place him <i>within</i> a Mexican context. [BNC A6U 324]
144.	<i>across</i>	They fitted smoke alarms to their home, put steel bars <i>across</i> the front door and screwed brackets across the fire escape which had disastrous consequences. [BNC A88 550]
145.	<i>inside</i>	I put my hand <i>inside</i> his coat and took hold of that wallet. [BNC A73 3179]
146.	<i>behind</i>	Even after deciding to put public service <i>behind</i> him ... [BNC A6L 554]
147.	<i>alongside</i>	The first is a puzzle that will not surprise those who put economists <i>alongside</i> journalists and car dealers in their not-to-be-trusted rankings. [BNC ABJ 3210]



	The functional word	Predicate complement in resultative constructions
148.	<i>under</i>	He placed a chocolate <i>under</i> his tongue and waited for it to melt down. [BNC A0U 817]
149.	N.S.E.W.	The 38th parallel was an obvious line to adopt and had the merit from the American viewpoint of placing the border <i>north</i> of Seoul; this maximised the territory under American direction. [BNC EDP 277]
150.	<i>instead</i>	Look for natural materials such as cloth, leather, natural fleece and metal, and consider buying books <i>instead</i> of toys. [BNC C8A 1842]
151.	<i>minus</i>	*
152.	<i>versus</i>	So the case was: put river <i>versus</i> drain. [BNC AS4 11]
153.	<i>per</i>	Children are usually placed one <i>per</i> home after being "matched" with treatment foster parents who are recruited ... [COCA, ACAD EmotBehavDis]
154.	<i>gone</i> (BrE)	*
155.	<i>since</i> (temporal)	*
156.	<i>since</i> (non-temporal)	*
157.	<i>as</i> (temporal)	*
158.	<i>as</i> (causative)	*
159.	<i>on</i> (locative)	I went over to the bed, climbed on top of it, put my head <i>on</i> the pillow and fell asleep. [BNC A0F 2783]
160.	<i>on</i> (concerning)	*
161.	<i>on</i> (non-locative)	You said yourself she wouldn't have begun putting the pressure <i>on</i> yet. [BNC A0D 2481]
162.	<i>off</i> (locative)	... but don't let that put you <i>off</i> . [BNC A6A 412]
163.	<i>off</i> (non-locative)	*
164.	<i>outside</i> (locative)	It was quite rough at times — and on one occasion, I found a body <i>outside</i> . [BNC AB5 468]
165.	<i>outside</i> (exception)	*
166.	<i>in</i> (locative)	No journalist will risk prison to put an article <i>in</i> the paper. [BNC A03 889]
167.	<i>in</i> (non-locative)	*
168.	<i>that</i> (purposive)	*
169.	<i>that</i> (empty)	*
170.	<i>while</i> (temporal)	*
171.	<i>while</i> (concessive)	*
172.	<i>whilst</i> (temporal)	*
173.	<i>whilst</i> (concessive)	*
174.	<i>apart</i> (away)	Whatever Niki says, the accident had put him <i>apart</i> and it was, then — for later his scars became part of his persona — difficult to look at him. [BNC CD9 575]
175.	<i>aside</i> (away)	In an evaluation the critic may put personal feeling <i>aside</i> . [BNC A04 1573]
176.	<i>apart</i> (exception)	*
177.	<i>aside</i> (exception)	*
178.	<i>by</i> (non-locative)	*
179.	<i>by</i> (locative)	Philip found him <i>by</i> the door into the yard. [BNC ABX 2179]
180.	<i>at</i>	This in turn will be supplemented by other key decisions last night: for a law — unprecedented here placing emergency powers <i>at</i> the government's disposal by the end of October rail traffic. [BNC A2F 126]
181.	<i>about</i> (locative)	*
182.	<i>about</i> (concerning)	*
183.	<i>worth</i>	*
184.	<i>near</i>	When I die, put me <i>near</i> something that has loved the light, and had the sky above it always. [BNC ACA 856]
185.	<i>close</i>	We made a rough table and two benches from wagon boards and put them <i>close</i> to the fire. [COCA, FIC Bk:ImpatientWithDesire]
186.	<i>far</i>	Figuring a six-hour walk put them <i>far</i> enough out of harm's way, they stopped at midnight and Htoo Moo slept ... [COCA, MAG MotherJones]

Property 20: Non-predicative modifier

	The functional word	Non-predicative modifier
	<i>with</i>	In this way, <i>with</i> a little money but much commitment, a great deal can be done. [BNC A00 185]
1.	<i>for fear</i>	Jane nodded, afraid to speak <i>for fear</i> of damming the flow. [BNC ABW 1647]
2.	<i>of</i>	*
3.	<i>in order</i>	<i>In order</i> to get rid of the whole web of interlinked concepts, myths, wishes and desires, one has to mine it from within. [BNC A08 1451]
4.	<i>on condition</i>	Much to my surprise she agreed, <i>on condition</i> that we had separate rooms and made our own travel arrangements. [BNC BMR 1799]
5.	<i>as to</i>	But, <i>as to</i> clinching things, Stavrogin is not Tikhon, which evokes another of my dicta ... [BNC A18 1020]
6.	<i>as for</i>	<i>As for</i> a varied painter, only one work is likely to appear in a survey. [BNC A04 433]
7.	<i>for all</i>	<i>For all</i> his standard procedures, I don't think he is actually imitating anybody. [BNC A05 589]
8.	<i>as soon as</i>	I'll arrange for the carriers to come down <i>as soon as</i> I get back. [BNC A08 3124]
9.	<i>as long as</i>	I will never forgive you <i>as long as</i> I live, he said. [BNC A08 844]
10.	<i>in case</i>	The text is enclosed here for information, <i>in case</i> local organisations are approached about it. [BNC A10 90]
11.	<i>in the event</i>	This formed part of a defence line erected to defend Britain <i>in the event</i> of a German establishment of a beach head in Cornwall. [BNC A2B 19]
12.	<i>on the basis</i>	'The Council must of course proceed <i>on the basis</i> of the vote,' he said. [BNC A0R 1498]
13.	<i>on the grounds</i>	The previous May, 13 of his co-defendants were acquitted and released unconditionally <i>on the grounds</i> that there was insufficient evidence for prosecution. [BNC A03 442]
14.	<i>to the effect</i>	The stone pillar carries an inscription <i>to the effect</i> that the pump was put up by the Earl of Upper Ossory in 1785. [BNC B0A 74]
15.	<i>all over</i>	Over the last year thousands of films have been produced <i>all over</i> the world. [BNC A0E 213]
16.	<i>in two minds</i>	*
17.	<i>here</i>	There is no prison <i>here</i> . [BNC A03 849]
18.	<i>there</i>	This is a knowledge which has been impugned in literature, and which has deteriorated <i>there</i> . [BNC A05 1358]
19.	<i>now</i>	<i>Now</i> , what we've got here is a lump of wood roughly the same shape trying to be a cricket bat ... [BNC A06 1023]
20.	<i>upstairs, downstairs</i>	She strolled <i>upstairs</i> . [BNC A0L 3556]
21.	<i>uphill, downhill</i>	We then cycled <i>uphill</i> to the town of Rosebush with its deserted slate quarries. [BNC A65 758]
22.	<i>upstage, downstage</i>	He would plant her <i>downstage</i> and get her to start playing ... [BNC FSP 90]
23.	<i>upstream, downstream</i>	<i>Downstream</i> , the Bartensham section is turning up some good roach. [BNC A6R 1044]
24.	<i>overseas, overboard, overhead, overland</i>	Projecting and protecting British interests <i>overseas</i> . [BNC ABA 50]
25.	<i>underfoot</i>	<i>Underfoot</i> the ice creaked and groaned dubiously: we were over the sea. [BNC ARB 1948]
26.	<i>underground</i>	Demand would merely be driven <i>underground</i> , ... [BNC A44 39]
27.	<i>home</i>	When I arrived <i>home</i> , I sat down at my desk and wrote a letter. [BNC A0F 280]
28.	<i>outdoors, indoors</i>	<i>Outdoors</i> , sound will 'evaporate', so you need to compensate with more power. [BNC ADK 951]
29.	<i>back</i>	<i>Back</i> in Italy, after his departure from Auschwitz and his wanderings through Europe, he found that 'the things I had seen and suffered were burning inside of me', and that he wanted to write about them. [BNC A05 1434]
30.	<i>backward(s), forward(s), upward(s), downward(s), inward(s), outward(s), eastward(s), northward(s), southward(s), westward(s), eastward(s), leftward(s), rightward(s), homeward(s), skyward(s), heavenward(s), seaward(s)</i>	It is safe to push <i>backwards</i> , ... [BNC A0H 159]
31.	<i>abroad</i>	In the 1860s Dostoevsky was spending a lot of time <i>abroad</i> . [BNC A18 610]
32.	<i>adrift</i>	*

	The functional word	Non-predicative modifier
33.	<i>aloft</i>	Behind the house, a rotting clothes line stretched, a forked hazel bough still holding it <i>aloft</i> . [BNC ASE 1772]
34.	<i>aground</i>	The World No 1 ran <i>aground</i> at Tryall's treacherous 15th hole but floated a shot ahead of Greg Norman and Tom Kite with a one-over-par 141. [BNC CBG 12279]
35.	<i>ashore</i>	His body was washed <i>ashore</i> on what was to become Omaha Beach. [BNC A67 911]
36.	<i>contrary</i>	<i>Contrary</i> to reports in Paris last week, government investigators working at the central police laboratory here have ruled out the presence of the Czechoslovak-made explosive Semtex, which caused the Lockerbie disaster. [BNC A2M 230]
37.	<i>counter</i>	Now — <i>counter</i> to the previous syllogism: tricky one, follow me carefully, it may prove a comfort. [BNC FU6 192]
38.	<i>exclusive</i>	<i>Exclusive</i> to Club 18–30 and of a very high standard, you'll find the Aquarium hotel difficult to beat for a fantastic holiday in Majorca. [BNC AM0 730]
39.	<i>pursuant</i>	<i>Pursuant</i> to the warrant, an intercept was placed on Mr. Cox's telephone in or about August 1983 and I saw the products of the intercept in the form of transcripts of recorded telephone conversations. [BNC ASB 980]
40.	<i>subsequent</i>	<i>Subsequent</i> to the first plan being drafted, three Spanish gas fields were discovered ... [BNC AT8 632]
41.	<i>previous</i>	Since <i>previous</i> to the revolution the majority of women had very low levels of education ... [BNC AN3 435]
42.	<i>preparatory</i>	The NVQ units for languages (Levels 1–5) were piloted, <i>preparatory</i> to their launch next year. [BNC HBP 563]
43.	<i>preliminary</i>	The infection was incidental to an angiogram, <i>preliminary</i> to a stent being inserted. [COCA, MAG SatEvenPost]
44.	<i>prior</i>	<i>Prior</i> to the establishment of the modern police system, the control of this underclass was the responsibility of the army working for the monarch or government. [BNC A0K 12]
45.	<i>adjacent</i>	<i>Adjacent</i> to the Winery you will find a selection of Period Oak & Country Furniture ... [BNC B3K 1663]
46.	<i>unbeknown(st)</i>	Perhaps, <i>unbeknownst</i> to me, she had worked her way through graduate school pushing grand pianos down stairways ... [BNC B72 1761]
47.	<i>further</i> (reference)	<i>Further</i> to my letter of yesterday, I now am able to send you your copy of the OALDCE 3/e Electronic computer tape ... [BNC AP1 303]
48.	<i>consequent</i>	'And, <i>consequent</i> to your failure, I doubt if I'll have any more intruders in my cloud.' [BNC GVL 3598]
49.	<i>due</i>	<i>Due</i> to the circumstances of the original build, there are some strange anomalies in the plan ... [BNC A0B 400]
50.	<i>next</i>	<i>Next</i> to it, there's a street, Regent Street, with balconies. [BNC B24 2399]
51.	<i>away</i>	<i>Away</i> from the hotel there's plenty to discover as you ramble or cycle around this little island (cars are not allowed). [BNC BPF 2017]
52.	<i>out</i>	Then you had on Friday, all of a sudden, out of the clear blue sky, statement from the president with no explanation ... [COCA SPOK FoxFive]
53.	<i>abreast</i>	In full kit with helmets a dull grey, they stamped on three <i>abreast</i> . [BNC ALL 1924]
54.	<i>aboard</i>	We climbed <i>aboard</i> the transport ... [BNC A61 2315]
55.	<i>down</i>	She survived the fall <i>down</i> the hill. [BNC A0D 424]
56.	<i>up</i>	Fay and Sara rode <i>up</i> a steep track. [BNC AOR 2246]
57.	<i>over</i>	Tony has been unwell <i>over</i> the weekend. [BNC A00 376]
58.	<i>along</i>	<i>Along</i> with the thousands of appeal letters sent as a result of Amnesty's campaign, perhaps the clearest direct pressure is being exerted by the Sri Lanka Aid Consortium, made up of donor governments and multi-lateral institutions. [BNC A03 765]
59.	<i>ahead</i>	The Tories had again moved <i>ahead</i> in the polls at the start of September. [BNC A66 292]
60.	<i>less</i> ('minus')	*
61.	<i>thanks</i>	Recently, <i>thanks</i> to legislation from the EC, all drinkers have to state their alcoholic strength by volume (ABV). [BNC A14 164]
62.	<i>owing</i>	<i>Owing</i> to the extremely high inflation there, prices are often quoted in Deutschmarks. [BNC A3T 450]
63.	<i>according</i>	<i>According</i> to those at the vigil, the police only checked on the hose twice before the massacre occurred at 4am. [BNC A03 923]
64.	<i>regarding</i>	Be extra vigilant <i>regarding</i> house security. [BNC A70 1393]
65.	<i>from</i>	In consequence of his success, mills using both stones and rollers were built in Britain <i>from</i> the 1860s. [BNC A79 953]
66.	<i>upon</i>	<i>Upon</i> his release from prison, his shorn flock welcomed him back with open arms. [COCA, FIC Bk:DesertWindLena]
67.	<i>because</i>	He concentrated on it <i>because</i> he loved it ... [BNC A04 656]



	The functional word	Non-predicative modifier
68.	<i>although</i>	<i>Although</i> ACET, like any charity, does not have the power to release you from the agreement it is likely to be sympathetic. [BNC A01 305]
69.	<i>whereas</i>	<i>Whereas</i> greens and blues are cool and make flowers seem to recede, reds and yellows are warm colours that attract attention and stand forward from paler flowers. [BNC A0G 2581]
70.	<i>via</i>	Jeff came into teaching <i>via</i> the practical side of art. [BNC A0F 498]
71.	<i>when</i>	<i>When</i> someone is ill with AIDS they are often in pain. [BNC A01 185]
72.	<i>where</i>	Kenya Asians are now working hard in the darkness and grime of British cities, <i>where</i> Patel is among the commonest names in the telephone directory. [BNC A05 150]
73.	<i>until</i>	Please continue to write <i>until</i> all the prisoners of conscience in the series are free ... [BNC A03 275]
74.	<i>after</i>	<i>After</i> only three years we are now caring for one in four of those dying with AIDS in the UK. [BNC A02 22]
75.	<i>before</i>	Just <i>before</i> leaving to attend the Conference itself, Patrick fitted in a live broadcast on Radio 4's 'Today Programme'. [BNC A00 210]
76.	<i>whether</i>	<i>Whether</i> the final total is £5 or £5,000, it is all very much needed. [BNC A00 41]
77.	<i>without</i>	<i>Without</i> that certificate, the charity cannot obtain the repayment of the basic rate tax and the donor cannot get higher rate relief. [BNC A01 330]
78.	<i>ago</i>	Fifty years <i>ago</i> they were in closer touch. [BNC A04 82]
79.	<i>into</i>	Klima's girl disappears <i>into</i> the Prague bars, leaving him with an imaginary address. [BNC A05 695]
80.	<i>onto</i>	She cleared her desk <i>onto</i> the floor, made coffee and switched on the typewriter. [BNC A0L 358]
81.	<i>between</i>	<i>Between</i> 1984 and 1986 those with AIDS died on average some ten months after diagnosis. [BNC A00 253]
82.	<i>amid</i>	I stood <i>amid</i> a gaggle of laughing students in frozen silence, and read the list over and over again. [BNC A0F 12]
83.	<i>among</i>	A close relationship developed <i>among</i> the visitors. [BNC A03 825]
84.	<i>against</i>	He argued <i>against</i> an excessively formalist type of analysis of art, ... [BNC A04 310]
85.	<i>beside</i>	Peggy sat down <i>beside</i> him. [BNC A0D 1199]
86.	<i>during</i>	Telephone Janet Sutton <i>during</i> office hours if you would like to know more about us, and how we might be able to help you. [BNC A01 501]
87.	<i>come</i>	<i>Come</i> next spring, you should have lots of new young plants — and all for free! [BNC A0G 1949]
88.	<i>absent</i>	<i>Absent</i> this provision, the quotation will be an offer. [BNC J6T 590]
89.	<i>counting</i>	<i>Counting</i> the Treasurer, this gives attendances of 41, six and two, which do indeed sum to 49. [BNC AAV 658]
90.	<i>touching</i>	Other essays continue this theme, <i>touching</i> on topics from green jobs [COCA, MAG EEnvironmental]
91.	<i>respecting</i>	To equip the Church to make an effective Christian response to AIDS, <i>respecting</i> the historic teachings of the church and providing unconditional care. [BNC A01 573]
92.	<i>concerning</i>	<i>Concerning</i> fitting an eight-cylinder engine to the new Rover 800, would it be technically feasible to use two K-series blocks side by side? [BNC A6X 888]
93.	<i>considering</i>	<i>Considering</i> that so many gliders are flown across country on every possible soaring day, the accident rate for <i>gliding</i> is extremely low. [BNC A0H 9]
94.	<i>following</i>	<i>Following</i> the running of an AIDS educational course for 60 people including doctors, nurses and teachers in Brasov, Romania, earlier this year, a follow-up day was held in April. [BNC A00 344]
95.	<i>failing</i>	<i>Failing</i> payment of the £30 the Company's promise would fall to the ground. [BNC B2S 1338]
96.	<i>barring</i>	<i>Barring</i> a handful for specialist duties, every locomotive was equipped with air brakes. [BNC A11 1539]
97.	<i>excluding</i>	<i>Excluding</i> workers returning from a strike, the number of new jobs grew by 134,000 in September, well below expectations, while job growth in August was revised down sharply. [BNC A37 85]
98.	<i>including</i>	Literary theory, drawing on other disciplines, <i>including</i> semiotics and linguistics, seeks for underlying structures and meanings in literature. [BNC A04 364]
99.	<i>pending</i>	However, it remains concerned that there has been no stay on sentences or executions <i>pending</i> the review of existing legislation. [BNC A03 201]
100.	<i>excepting</i>	The Clio reaches us in perfect condition, <i>excepting</i> a few scuffs on the steel wheel trims. [BNC A6X 1834]
101.	<i>turning</i>	<i>Turning</i> to what she called 'the heart of the matter', the Prime Minister said: 'Remove man's freedom and you dwarf the individual, you devalue his conscience and you demoralise him.' [BNC A5W 256]



	The functional word	Non-predicative modifier
102.	<i>pertaining</i>	The resistance to taking mental events as spatial seems also to have to do with something less specific, <i>pertaining</i> to those of them which are perceptual and also those which are representative. [BNC EVX 1555]
103.	<i>bearing</i>	<i>Bearing</i> in mind the need for Poland and Hungary to reach rapid agreement with international financial institutions, the Council (of ministers) recognises the urgent need for additional measures of support. [BNC A28 363]
104.	<i>having</i>	<i>Having</i> said that, this season has seen the best conditions for controlling the weed for some time. [BNC ACR 123]
105.	<i>given</i>	<i>Given</i> their prime location in the centre of towns and on major thoroughfares, Georgian coaching inns are frequently prime targets for refurbishment. [BNC A0B 230]
106.	<i>granted</i>	<i>Granted</i> that there is an absolute need for humanistic values to prevail in a neo-utilitarian and materialistic age, one is faced with a significant divergence in the nature of these values. [BNC A1A 1264]
107.	<i>provided</i>	<i>Provided</i> that the pilot keeps to the correct procedures, winch and car launches can be very safe. [BNC A0H 568]
108.	<i>providing</i>	<i>Providing</i> the disabled person is entitled to receive mobility allowance, it need not necessarily be the disabled person who has to be the driver of the vehicle. [BNC A0J 2060]
109.	<i>supposing</i>	<i>Supposing</i> that we did turn away from the cheap arguments, where could we find a better way? [BNC A5A 126]
110.	<i>assuming</i>	<i>Assuming</i> licensees and magistrates act sensibly in seeking and granting approval, I cannot see any strong objection to this. [BNC A14 198]
111.	<i>seeing</i>	<i>Seeing</i> that a fine picture is nature reflected by an artist, the criticism which I approve will be that picture reflected by an intelligent and sensitive mind. [BNC A04 217]
112.	<i>allowing</i>	They spurred each other on, <i>allowing</i> the action and the words to flow naturally. [BNC A0P 1546]
113.	<i>bar</i>	Surely it's over <i>bar</i> the paperwork. [BNC GWB 2581]
114.	<i>except</i>	His hands were manacled behind his back <i>except</i> when he ate or slept. [BNC A03 549]
115.	<i>if</i>	<i>If</i> I can't take him he will have a two-hour wait for an ambulance. [BNC A00 399]
116.	<i>regardless</i>	<i>Regardless</i> of whether we are talking isolated or non-isolated, however, the capacitors introduce two entirely non-trivial problems. [BNC A19 589]
117.	<i>besides</i>	There are many more definitions of art <i>besides</i> Tolstoy's own and those which he denounced. [BNC A04 8]
118.	<i>irrespective</i>	It concentrates on identified market segments, <i>irrespective</i> of the geographic location. [BNC A60 161]
119.	<i>apropos</i>	Or <i>apropos</i> of the necessity of having a good historical imagination when reading, 'I had much rather know what I should feel like if I adopted the beliefs of Lucretius than how Lucretius would have felt if he had never entertained them.' [BNC A7C 1374]
120.	<i>but</i>	Van Gogh is famous not only for his art, <i>but</i> for his writing. [BNC A04 824]
121.	<i>albeit</i>	Jaguar's classy convertibles start at £41,200, <i>albeit</i> with V12 power. [BNC A38 125]
122.	<i>notwithstanding</i>	<i>Notwithstanding</i> current problems which they discussed lightly, it had all been wonderful. [BNC AC2 1394]
123.	<i>though</i>	This will result in the book evading the task of art criticism altogether, <i>though</i> the critical views of the artist may be recorded. [BNC A04 796]
124.	<i>whenever</i>	I have to take off my shoes <i>whenever</i> I can. [BNC A08 1700]
125.	<i>wherever</i>	Thus, wherever one looks, one finds people engaged in the construction on the blocks that will make up the Palestinian state [BNC A9J 34]
126.	<i>once (temporal)</i>	<i>Once</i> you have decided you would like practical help from ACET just ring 081 840 7879 and ask for Home Care. [BNC A01 487]
127.	<i>once (TIMES)</i>	... even if you only do it <i>once</i> . [BNC A01 132]
128.	<i>unless</i>	But, <i>unless</i> you are considering a particularly large donation, it is unlikely that you would need to include any complicated form of wording. [BNC A01 309]
129.	<i>lest</i>	I worried all night, <i>lest</i> the listing in the local paper and in the Order of St John country handbook had not been enough. [BNC A0G 199]
130.	<i>whereupon</i>	The last wicket fell at 450, <i>whereupon</i> England promptly collapsed to 32 for 3. [BNC ABR 139]
131.	<i>opposite</i>	Opposite the hotel there is a colourful weekly flower market which fills the air with fresh and fragrant smells. [BNC ECF 4717]
132.	<i>beyond</i>	<i>Beyond</i> speech now, she nodded her comprehension. [BNC A0D 2718]
133.	<i>past</i>	He walked <i>past</i> Claire's room ... [BNC A0D 1836]
134.	<i>below</i>	<i>Below</i> that speed it is impossible to generate sufficient lift to overload the weak link. [BNC A0H 607]
135.	<i>above</i>	The main cloud base should be at least 2000 feet <i>above</i> the highest ground in the region ... [BNC A0H 1550]
136.	<i>round</i>	She set her things <i>round</i> the monastic student bedroom. [BNC A0L 608]



	The functional word	Non-predicative modifier
137.	<i>underneath</i>	And <i>underneath</i> these feelings he felt some hot, dark stirrings in himself. [BNC A0N 1005]
138.	<i>beneath</i>	<i>Beneath</i> his pale and archetypally reserved exterior something burned and melted, hardened then softened. [BNC AOU 777]
139.	<i>around</i>	You can at least organise your life <i>around</i> your aims and ambitions. [BNC A06 1793]
140.	<i>throughout</i>	<i>Throughout</i> drama school there will be continuous work on acting solo pieces ... [BNC A06 1375]
141.	<i>through</i>	Secondly, <i>through</i> the enactment of a special powers Act in 1922 Stormont gave itself and its police force the powers of detention without trial. [A07 112]
142.	<i>within</i>	<i>Within</i> a short space of time referrals were regularly coming in. [BNC A00 363]
143.	<i>across</i>	Despite public perceptions, <i>across</i> the world 7 out of 10 infections are heterosexual. [BNC A02 48]
144.	<i>inside</i>	Maria was last seen shouting for help <i>inside</i> a military jeep that evening. [BNC A03 524]
145.	<i>behind</i>	I shut the door <i>behind</i> him and locked it. [BNC A08 3108]
146.	<i>alongside</i>	Happily achievements do take place <i>alongside</i> such nonsense. [BNC A11 79]
147.	<i>under</i>	<i>Under</i> Gift Aid there are no formalities at the time of the gift, just a cheque or cash gift to the charity. [BNC A01 342]
148.	N.S.E.W.	Sometimes they had driven <i>north</i> ... [BNC CDE 1813]
149.	<i>instead</i>	Then, ' <i>Instead</i> of struggling in vain to prevent them from reaching my consciousness, I stepped back, as it were, and let thoughts and feelings come and go. [BNC A04 1618]
150.	<i>minus</i>	*
151.	<i>versus</i>	*
152.	<i>per</i>	*
153.	<i>gone</i> (BrE)	*
154.	<i>since</i> (temporal)	This can cause problems, <i>since</i> you agree under the terms of the covenant to make payments out of income from which tax has been deducted. [BNC A01 283]
155.	<i>since</i> (non-temporal)	<i>Since</i> black people in the southern states have suffered more injustices at the hands of the law they tend to be less likely to hand out death sentences. [BNC A03 718]
156.	<i>as</i> (temporal)	An ACET-link will play a vital role <i>as</i> our work is growing so rapidly. [BNC A00 175]
157.	<i>as</i> (causative)	<i>As</i> London's largest independent provider of community care for people ill with AIDS, staff at ACET have seen these changes unfold in the home. [BNC A00 268]
158.	<i>on</i> (locative)	<i>On</i> the doormat, there were a few late Christmas cards plus the inevitable letter from the bank, but no offers of job interviews. [BNC A0F 373]
159.	<i>on</i> (concerning)	There is nearly always a strong emphasis on the classical theatre, usually <i>on</i> Shakespeare ... [BNC A06 108]
160.	<i>on</i> (non-locative)	*
161.	<i>off</i> (locative)	His opponent, Mr Jones wins each of his three games <i>off</i> the first advantage from deuce. [BNC A0V 909]
162.	<i>off</i> (non-locative)	*
163.	<i>outside</i> (locative)	<i>Outside</i> the church the statistics are higher still. [BNC A01 530]
164.	<i>outside</i> (exception)	<i>Outside</i> of Dagenham and East London, the home of Fords, it is the biggest centre of industry left in London. [BNC A6V 1340]
165.	<i>in</i> (locative)	... he met with patients <i>in</i> the villages and with other agencies ... [BNC A00 181]
166.	<i>in</i> (non-locative)	<i>In</i> recognition of their importance and the need to train more volunteers, we want to develop links with individual churches. [BNC A00 172]
167.	<i>that</i> (purposive)	Give me one look, <i>that</i> I may see his face so beautiful. [OED: 1816]
168.	<i>that</i> (empty)	*
169.	<i>while</i> (temporal)	<i>While</i> over 2,300 people wait on death rows countrywide to see if they will die or not, we can only hope that the US comes to its senses soon. [BNC A03 749]
170.	<i>while</i> (concessive)	<i>While</i> deciding to stay as independent as possible, I contacted ACET who I knew provided practical care at home. [BNC A00 192]
171.	<i>whilst</i> (temporal)	First aid for a bleeding nose is to pinch the nostrils closed <i>whilst</i> tilting the head back. [BNC A0M 1375]
172.	<i>whilst</i> (concessive)	<i>Whilst</i> the age of the theme pub may be over, more and more old pubs are being transformed into identical, pseudo-historical clones. [BNC A0B 75]
173.	<i>apart</i> (away)	In 1977 the skein of any agreement on wages policy began to come <i>apart</i> . [BNC A66 234]
174.	<i>aside</i> (away)	I think you and I should draw <i>aside</i> and discuss this matter, Mr Magistrate. [BNC HHC 83]
175.	<i>apart</i> (exception)	<i>Apart</i> from art criticism and art history, there exist several other types of writing about art. [BNC A04 115]
176.	<i>apart from</i>	<i>Apart from</i> art criticism and art history, there exist several other types of writing about art. [BNC A04 115]
177.	<i>aside</i> (exception)	<i>Aside</i> from the technological requirements of the new system, other important issues have to be resolved. [BNC A1E 47]



	The functional word	Non-predicative modifier
178.	by (non-locative)	'I was impressed <i>by</i> the care given to our clients in London and elsewhere,' [BNC A00 295]
179.	by (locative)	He walked by the tree shade of sunny winking leaves, and towards him came the wife of Mr David Shehee MP. [BNC KRH 4787]
180.	at	Peter studied astronomy <i>at</i> University College, London, and worked in accountancy for a short spell before deciding upon a career in nursing. [BNC A00 297]
181.	about (locative)	She was moving <i>about</i> the room now ... [BNC A73 1660]
182.	about (concerning)	We also educate young people in schools <i>about</i> the dangers of drug use. [BNC A02 158]
183.	worth	*
184.	near	In another part of the city, <i>near</i> the Gethsemane church in the run-down Prenzlauer Berg district, police attacked a candlelit procession by about 1,000 young people, beating them about the head with truncheons, as the crowd chanted 'no violence'. [BNC A41 5]
185.	close	The female head louse lays shiny yellow eggs and glues them one by one to individual hairs, <i>close</i> to the scalp. [BNC A0J 1178]
186.	far	That, <i>far from</i> producing better disciplined people, smacking makes it much more difficult to teach children how to behave. [BNC A2C 51]

Appendix 4. Tags used to run BNC and COCA searches

Syntactic property	BNC	COCA
Complement widely cited as prepositional	Prepcomp _PR*	
No/Null complement	prepcomp _PUN	
NP complement	prepcomp (_NN* _NP0 _PNP)	
Adverbial complement	prepcomp _AV0	prepcomp _r*
<i>that</i> -clause complement	prepcomp _CJT	
<i>that</i> -less-clause complement	prepcomp (_CJS _CJT)	
Topicalisation	prepcomp (_CJS) *** (_NN* _NP0 _PNP)	
Small clause complement: overt subject and not <i>-ing</i> predicate	prepcomp (_AT0 _DT0) (_AJ*) (_NN* _NP0 _PNP) (_PR* _AJ* TO0)	prepcomp _n* _v?g*
Small clause complement: raised subject and <i>-ing</i> predicate	prepcomp _V?G	
Small clause complement: raised subj and not <i>-ing</i> predicate	prepcomp (_PR* _AJ* ** _N*)	prepcomp _v?g*
Small clause complement: overt subj and <i>-ing</i> predicate	prepcomp (_AT0 _DT0) (_AJ*) (_NN* _NP0 _PNP) _V?G	
Postmodifier of NP	(_AT0 _DT0) (_AJ*) _NN* prepcomp	_nn* prepcomp
NP-like distribution	_PR* prepcomp OR prepcomp ***** _V*	_i* prepcomp
Measure phrase	_CRD _N* prepcomp	_mc* _n* prepcomp
<i>Right/Straight</i> modification	(right straight) prepcomp	
Particle shift	_VV* ** _AVP	
Predicate in raising constructions with BE	(_VBB _VBD _VBZ) prepcomp	_vb* prepcomp
Predicate in resultative-like constructions	({put} {place} {find} {leave} {see} {take} {throw} {set}) ** (_N* _NP0 _PN*) prepcomp	_v* _p* prepcomp
Non-predicative modifier	_PUN prepcomp	_y* prepcomp
Postmodifier of NP	_NN* prepcomp	

Appendix 5. Comparing the distribution of the prepcomp words

- A: what is commonly known as prepositional complement
 B: no/null complement
 C: NP complement
 D: adverbial complement
 E: that-clause complement
 F: that-less clause complement
 G: topicalisation
 H: small clause comp: subject is overt and pred is verbal
 I: small clause comp: subject is overt and pred is non-verbal
 J: small clause comp: subject of comp is raised and pred is verbal
 K: small clause comp: subject of comp is raised and the pred is non-verbal
 L: complement in a coordinated form
 M: postmodifier of NP
 N: null head/ "NP"-distribution-like
 O: measure phrase
 P: *right/straight* modifiers
 Q: particle shift
 R: predicate complement in raising constructions
 S: predicate complement in resultative constructions
 T: non-predicative modifier

	A	B	C	D	E	F	G	H	I	J	K	L	M	N	O	P	Q	R	S	T
<i>with</i>	*	*	✓	*	*	*	*	✓	✓	✓	*	*	✓	*	*	*	*	✓	✓	✓
<i>for fear</i>	✓	*	*	*	✓	✓	✓	*	*	*	*	*	✓	*	*	*	*	✓	*	✓
<i>of</i>	*	*	✓	*	*	*	*	✓	✓	✓	*	*	✓	*	*	*	*	✓	*	*
<i>in order</i>	*	*	*	*	✓	✓	✓	*	*	*	*	*	✓	*	*	*	*	✓	*	✓
<i>on condition</i>	*	*	*	*	✓	✓	✓	*	*	*	*	*	✓	*	*	*	*	✓	*	✓
<i>as to</i>	*	*	✓	*	*	✓	*	*	*	*	*	*	*	*	*	*	*	*	*	✓
<i>as for</i>	*	*	✓	*	*	*	*	*	*	*	*	*	*	*	*	*	*	*	*	✓
<i>for all</i>	*	*	✓	*	✓	✓	*	*	*	*	*	*	*	*	*	*	*	*	*	✓
<i>as soon as</i>	*	*	*	*	*	✓	✓	*	*	*	*	*	✓	*	*	*	*	✓	*	✓
<i>as long as</i>	*	*	*	*	*	✓	✓	*	*	*	*	*	✓			*	*	✓	*	✓
<i>in case</i>	✓	✓	*	*	*	✓	✓	*	*	*	*	*	*	*	*	*	*	✓	*	✓
<i>in the event</i>	✓	*	*	*	✓	✓	✓	*	*	*	*	*	✓	*	*	*	*	✓	*	✓
<i>on the basis</i>	✓	*	*	*	✓	✓	✓	*	*	*	*	*	✓	*	*	*	*	✓	*	✓
<i>on the grounds</i>	✓	*	*	*	✓	✓	✓	*	*	*	*	*	✓	*	*	*	*	✓	*	✓



	A	B	C	D	E	F	G	H	I	J	K	L	M	N	O	P	Q	R	S	T
<i>to the effect</i>	✓	*	*	*	✓	✓	✓	*	*	*	*	*	✓	*	*	*	*	✓	*	✓
<i>all over</i>	✓	✓	✓	*	*	*	*	*	*	*	*	*	✓	✓	*	✓	*	✓	✓	✓
<i>in two minds</i>	✓	✓	*	*	*	*	*	*	*	*	*	*	✓	*	*	*	*	✓	✓	*
<i>here</i>	*	✓	*	*	*	*	*	*	*	*	*	*	✓	✓	*	✓	*	✓	✓	✓
<i>there</i>	*	✓	*	*	*	*	*	*	*	*	*	*	✓	✓	*	✓	*	✓	✓	✓
<i>now</i>	*	✓	*	*	✓	✓	*	*	*	*	*	*	✓	✓	*	✓	*	✓	*	✓
<i>upstairs, downstairs</i>	*	✓	*	*	*	*	*	*	*	*	*	*	✓	✓	✓	✓	*	✓	✓	✓
<i>uphill, downhill</i>	*	✓	*	*	*	*	*	*	*	*	*	*	✓	✓	✓	✓	*	✓	✓	✓
<i>upstage, downstage</i>	*	✓	*	*	*	*	*	*	*	*	*	*	✓	✓	✓	✓	*	✓	✓	✓
<i>upstream, downstream</i>	*	✓	*	*	*	*	*	*	*	*	*	*	✓	✓	✓	✓	*	✓	✓	✓
<i>overseas, overboard, overhead, overland</i>	*	✓	*	*	*	*	*	*	*	*	*	*	✓	✓	*	✓	*	✓	✓	✓
<i>underfoot</i>	*	✓	*	*	*	*	*	*	*	*	*	*	✓	✓	✓	✓	*	✓	✓	✓
<i>underground</i>	*	✓	*	*	*	*	*	*	*	*	*	*	✓	✓	✓	✓	*	✓	✓	✓
<i>home</i>	*	✓	*	*	*	*	*	*	*	*	*	*	✓	✓	*	✓	*	✓	✓	✓
<i>outdoors, indoors</i>	*	✓	*	*	*	*	*	*	*	*	*	*	✓	✓	✓	✓	*	✓	✓	✓
<i>back</i>	✓	✓	*	*	*	*	*	*	*	*	*	*	✓	*	*	✓	✓	✓	✓	✓



	A	B	C	D	E	F	G	H	I	J	K	L	M	N	O	P	Q	R	S	T
<i>backward(s), forward(s), upward(s), downwards(s), inward(s), outward(s), eastward(s), northward(s), southward(s), westward(s), eastward(s), leftward(s), rightward(s), homeward(s), skyward(s), heavenward(s), seaward(s)</i>	*	✓	*	*	*	*	*	*	*	*	*	*	✓	✓	✓	✓	*	✓	✓	✓
<i>abroad</i>	*	✓	*	*	*	*	*	*	*	*	*	*	✓	✓	*	✓	*	✓	✓	✓
<i>adrift</i>	*	✓	*	*	*	*	*	*	*	*	*	*	✓	*	*	*	*	✓	✓	*
<i>aloft</i>	*	✓	*	*	*	*	*	*	*	*	*	*	✓	✓	✓	✓	*	✓	✓	✓
<i>aground</i>	*	✓	*	*	*	*	*	*	*	*	*	*	✓	*	*	*	*	✓	✓	✓
<i>ashore</i>	*	✓	*	*	*	*	*	*	*	*	*	*	✓	✓	*	✓	*	✓	✓	✓
<i>contrary</i>	✓	*	*	*	*	*	*	*	*	*	*	*	✓	*	*	*	*	✓	✓	✓
<i>counter</i>	✓	*	*	*	*	*	*	*	*	*	*	*	✓	*	*	*	*	✓	✓	✓
<i>exclusive</i>	✓	*	*	*	*	*	*	*	*	*	*	*	✓	*	*	*	*	✓	✓	✓
<i>pursuant</i>	✓	*	*	*	*	*	*	*	*	*	*	*	✓	*	*	*	*	✓	✓	✓
<i>subsequent</i>	✓	*	*	*	*	*	*	*	*	*	*	*	✓	*	*	*	*	✓	✓	✓
<i>previous</i>	✓	*	*	*	*	*	*	*	*	*	*	*	✓	*	*	*	*	✓	✓	✓
<i>preparatory</i>	✓	*	*	*	*	*	*	*	*	*	*	*	✓	*	*	*	*	✓	✓	✓
<i>preliminary</i>	✓	*	*	*	*	*	*	*	*	*	*	*	✓	*	*	*	*	✓	✓	✓
<i>prior</i>	✓	*	*	*	*	*	*	*	*	*	*	*	✓	*	*	*	*	✓	✓	✓
<i>adjacent</i>	✓	*	✓	*	*	*	*	*	*	*	*	*	✓	*	*	✓	*	✓	✓	✓
<i>unbeknown(st)</i>	✓	*	*	*	*	*	*	*	*	*	*	*	✓	*	*	*	*	✓	*	✓
<i>further</i> (reference)	✓	*	*	*	*	*	*	*	*	*	*	*	*	*	*	*	*	*	*	✓
<i>consequent</i>	✓	*	*	*	*	*	*	*	*	*	*	*	✓	*	*	*	*	✓	*	✓
<i>due</i>	✓	*	*	*	*	*	*	*	*	*	*	*	✓	*	*	*	*	✓	*	✓



	A	B	C	D	E	F	G	H	I	J	K	L	M	N	O	P	Q	R	S	T
<i>next</i>	✓	✓	*	*	*	*	*	*	*	*	*	*	✓	✓	*	✓	*	✓	✓	✓
<i>away</i>	✓	✓	*	*	*	*	*	*	*	*	*	*	✓	✓	✓	✓	✓	✓	✓	✓
<i>out</i>	✓	✓	✓	*	*	*	*	*	*	*	*	*	✓	✓	✓	✓	✓	✓	✓	✓
<i>abreast</i>	✓	✓	*	*	*	*	*	*	*	*	*	*	✓	*	*	✓	*	✓	✓	✓
<i>aboard</i>	*	✓	✓	*	*	*	*	*	*	*	*	*	✓	✓	*	✓	*	✓	✓	✓
<i>down</i>	✓	✓	✓	*	*	*	*	*	*	*	*	*	✓	✓	✓	✓	✓	✓	✓	✓
<i>up</i>	✓	✓	✓	*	*	*	*	*	*	*	*	*	✓	✓	✓	✓	✓	✓	✓	✓
<i>over</i>	✓	✓	✓	*	*	*	*	*	*	*	*	*	✓	✓	✓	✓	✓	✓	✓	✓
<i>along</i>	✓	✓	✓	*	*	*	*	*	*	*	*	*	✓	✓	✓	✓	✓	✓	✓	✓
<i>ahead</i>	✓	✓	*	*	*	*	*	*	*	*	*	*	✓	✓	✓	✓	*	✓	✓	✓
<i>less ('minus')</i>	✓	*	✓	*	*	*	*	*	*	*	*	*	✓	*	✓	*	*	✓	✓	✓
<i>thanks</i>	✓	*	*	*	*	*	*	*	*	*	*	*	*	*	*	*	*	✓	*	✓
<i>owing</i>	✓	*	*	*	*	*	*	*	*	*	*	*	*	*	*	*	*	✓	*	✓
<i>according</i>	✓	*	*	*	*	*	*	*	*	*	*	*	✓	*	*	*	*	✓	*	✓
<i>regarding</i>	*	*	✓	*	*	*	*	*	*	✓	*	*	✓	*	*	*	*	✓	*	✓
<i>from</i>	*	*	✓	*	*	*	*	*	*	✓	*	*	✓	*	✓	✓	*	✓	✓	✓
<i>upon</i>	*	*	✓	*	*	*	*	*	*	✓	*	*	✓	*	*	✓	*	✓	✓	✓
<i>because</i>	✓	*	*	*	*	✓	✓	*	*	*	*	*	✓	*	*	*	*	✓	*	✓
<i>although</i>	*	✓	*	*	*	✓	✓	*	*	*	*	*	*	*	*	*	*	*	*	✓
<i>whereas</i>	*	*	*	*	*	✓	✓	*	*	*	*	*	*	*	*	*	*	*	*	✓
<i>via</i>	*	*	✓	*	*	*	*	*	*	✓	*	*	✓	✓	*	*	*	✓	✓	✓
<i>when</i>	*	*	*	*	*	✓	✓	*	*	*	✓	*	✓	✓	*	✓	*	✓	*	✓
<i>where</i>	*	*	*	*	*	✓	✓	*	*	*	✓	*	✓	✓	*	✓	*	✓	*	✓
<i>until</i>	*	*	✓	✓	*	✓	✓	*	*	✓	✓	*	✓	*	✓	✓	*	✓	*	✓
<i>after</i>	*	✓	✓	*	*	✓	*	*	*	✓	*	*	✓	✓	✓	✓	*	✓	✓	✓
<i>before</i>	*	✓	✓	*	*	✓	*	*	*	✓	*	*	✓	✓	✓	✓	*	✓	✓	✓
<i>whether</i>	*	*	*	*	*	✓	✓	*	*	*	*	✓	✓	*	*	*	*	✓	*	✓
<i>without</i>	*	✓	✓	*	*	✓	✓	✓	✓	✓	*	*	✓	*	*	*	*	✓	✓	✓
<i>ago</i>	*	*	✓	*	*	*	*	*	*	*	*	*	✓	*	✓	*	*	✓	*	✓
<i>into</i>	*	*	✓	*	*	*	*	*	*	✓	*	*	✓	*	✓	✓	*	✓	✓	✓
<i>onto</i>	*	*	✓	*	*	*	*	*	*	*	*	*	✓	*	✓	✓	*	✓	✓	✓
<i>between</i>	*	✓	✓	*	*	*	*	*	*	*	*	*	✓	✓	*	✓	*	✓	✓	✓
<i>amid</i>	*	*	✓	*	*	*	*	*	*	*	*	*	✓	✓	*	✓	*	✓	✓	✓
<i>among</i>	*	*	✓	*	*	*	*	*	*	*	*	*	✓	✓	*	✓	*	✓	✓	✓
<i>against</i>	*	✓	✓	*	*	*	*	*	*	✓	*	*	✓	✓	*	✓	*	✓	✓	✓



	A	B	C	D	E	F	G	H	I	J	K	L	M	N	O	P	Q	R	S	T
<i>beside</i>	*	*	✓	*	*	*	*	*	*	*	*	*	✓	✓	*	✓	*	✓	✓	✓
<i>during</i>	*	*	✓	*	*	*	*	*	*	*	*	*	✓	✓	*	✓	*	✓	*	✓
<i>come</i>	*	*	✓	*	*	*	*	*	*	*	*	*	*	*	*	*	*	*	*	✓
<i>absent</i>	*	*	✓	*	*	*	*	*	*	*	*	*	*	*	*	*	*	*	*	✓
<i>counting</i>	*	*	✓	*	*	*	*	*	*	*	*	*	✓	*	*	*	*	✓	*	✓
<i>touching</i>	✓	*	✓	*	*	*	*	*	*	*	*	*	✓	*	*	*	*	✓	*	✓
<i>respecting</i>	*	*	✓	*	*	*	*	*	*	*	*	*	✓	*	*	*	*	✓	*	✓
<i>concerning</i>	*	*	✓	*	*	*	*	✓	*	*	*	*	✓	*	*	*	*	✓	*	✓
<i>considering</i>	*	✓	✓	*	✓	✓	✓	*	*	*	*	*	✓	*	*	*	*	✓	*	✓
<i>following</i>	✓	*	✓	*	*	*	*	*	*	*	*	*	✓	*	*	*	*	✓	*	✓
<i>failing</i>	*	*	✓	*	*	*	*	*	*	*	*	*	✓	*	*	*	*	✓	*	✓
<i>barring</i>	*	*	✓	*	*	*	*	*	*	*	*	*	✓	*	*	*	*	✓	*	✓
<i>excluding</i>	*	*	✓	*	*	*	*	*	*	*	*	*	✓	*	*	*	*	✓	*	✓
<i>including</i>	*	*	✓	*	*	*	*	*	*	*	*	*	✓	*	*	*	*	✓	*	✓
<i>pending</i>	*	*	✓	*	*	*	*	*	*	*	*	*	✓	*	*	*	*	✓	*	✓
<i>excepting</i>	✓	*	✓	*	✓		✓	*	*	*	✓	*	✓	*	*	*	*	✓	*	✓
<i>turning</i>	✓	*	*	*	*	*	*	*	*	*	*	*	*	*	*	*	*	✓	*	✓
<i>pertaining</i>	✓	*	*	*	*	*	*	*	*	*	*	*	*	*	*	*	*	✓	*	✓
<i>bearing</i>	*	*	*	*	*	*	*	*	*	*	✓	*	*	*	*	*	*	✓	*	✓
<i>having</i>	*	*	*	*	*	*	*	*	*	*	✓	*	*	*	*	*	*	✓	*	✓
<i>given</i>	*	*	✓	*	✓	✓	✓	*	*	*	*	*	*	*	*	*	*	*	*	✓
<i>granted</i>	*	✓	✓	*	✓	✓	✓	*	*	*	*	*	*	*	*	*	*	*	*	✓
<i>provided</i>	*	*	*	*	✓	✓	✓	*	*	*	*	*	*	*	*	*	*	*	*	✓
<i>providing</i>	*	*	*	*	✓	✓	✓	*	*	*	*	*	*	*	*	*	*	*	*	✓
<i>supposing</i>	*	*	*	*	✓	✓	✓	*	*	*	*	*	*	*	*	*	*	*	*	✓
<i>assuming</i>	*	*	✓	*	✓	✓	✓	*	*	*	*	*	*	*	*	*	*	*	*	✓
<i>seeing</i>	*	*	*	*	✓	✓	✓	*	*	*	*	*	*	*	*	*	*	*	*	✓
<i>allowing</i>	✓	*	*	*	✓	*	✓	*	*	*	*	*	*	*	*	*	*	*	*	✓
<i>bar</i>	*	*	✓	*	*	*	*	*	*	*	*	*	*	*	*	*	*	*	*	✓
<i>except</i>	✓	*	✓	*	✓	✓	✓	*	*	✓	✓	*	*	*	*	*	*	✓	*	✓
<i>if</i>	*	*	*	*	*	✓	✓	*	*	✓	✓	*	✓	*	*	*	*	✓	*	✓
<i>regardless</i>	✓	✓	*	*	*	*	*	*	*	*	*	*	✓	*	*	*	*	✓	*	✓
<i>besides</i>	*	✓	✓	*	*	*	*	*	*	✓	*	*	✓	*	*	*	*	✓	*	✓
<i>irrespective</i>	✓	*	*	*	*	*	*	*	*	*	*	*	*	*	*	*	*	✓	*	✓
<i>apropos</i>	✓	*	*	*	*	*	*	*	*	*	*	*	✓	*	*	*	*	✓	*	✓



	A	B	C	D	E	F	G	H	I	J	K	L	M	N	O	P	Q	R	S	T
<i>but</i>	✓	*	*	*	✓	✓	*	*	*	*	*	*	*	*	*	*	*	*	*	✓
<i>albeit</i>	*	✓	✓	✓	✓	✓	✓	*	*	*	✓	*	*	*	*	*	*	*	*	✓
<i>notwithstanding</i>	*	✓	✓	*	✓	✓	✓	*	*	*	*	*	✓	*	*	*	*	✓	*	✓
<i>though</i>	*	✓	*	*	*	✓	✓	*	*	*	*	*	*	*	*	*	*	*	*	✓
<i>whenever</i>	*	*	*	*	*	✓	✓	*	*	*	✓	*	✓	*	*	*	*	✓	*	✓
<i>wherever</i>	*	*	*	*	*	✓	✓	*	*	*	✓	*	✓	*	*	*	*	✓	*	✓
<i>once</i> (temporal)	*	*	*	*	*	✓	✓	*	*	*	*	*	*	*	*	*	*	✓	*	✓
<i>once</i> (TIMES)	*	✓	✓	✓	*	*	*	*	*	*	*	*	*	*	*	*	*	✓	*	✓
<i>unless</i>	*	*	*	*	*	✓	✓	*	*	*	✓	*	✓	*	*	*	*	✓	*	✓
<i>lest</i>	*	*	*	*	*	✓	✓	*	*	*	*	*	*	*	*	*	*	*	*	✓
<i>whereupon</i>	*	*	*	*	*	✓	✓	*	*	*	*	*	*	*	*	*	*	*	*	✓
<i>opposite</i>	✓	✓	✓	*	*	*	*	*	*	*	*	*	✓	✓	✓	✓	*	✓	✓	✓
<i>beyond</i>	*	✓	✓	*	*	*	*	*	*	*	*	*	✓	✓	✓	✓	*	✓	✓	✓
<i>past</i>	*	✓	✓	*	*	*	*	*	*	*	*	*	✓	✓	*	✓	*	✓	✓	✓
<i>below</i>	*	✓	✓	*	*	*	*	*	*	*	*	*	✓	✓	✓	✓	*	✓	✓	✓
<i>above</i>	*	✓	✓	*	*	*	*	*	*	*	*	*	✓	✓	✓	✓	*	✓	✓	✓
<i>round</i>	✓	✓	✓	*	*	*	*	*	*	*	*	*	✓	✓	✓	✓	✓	✓	✓	✓
<i>underneath</i>	*	✓	✓	*	*	*	*	*	*	*	*	*	✓	✓	✓	✓	*	✓	✓	✓
<i>beneath</i>	*	✓	✓	*	*	*	*	*	*	*	*	*	✓	✓	✓	✓	*	✓	✓	✓
<i>around</i>	✓	✓	✓	*	*	*	*	*	*	*	*	*	✓	✓	✓	✓	✓	✓	✓	✓
<i>throughout</i>	✓	✓	✓	*	*	*	*	*	*	*	*	*	✓	✓	*	✓	*	✓	✓	✓
<i>through</i>	✓	✓	✓	*	*	*	*	*	*	*	*	*	✓	✓	✓	✓	*	✓	✓	✓
<i>within</i>	*	✓	✓	*	*	*	*	*	*	*	*	*	✓	✓	✓	✓	*	✓	✓	✓
<i>across</i>	✓	✓	✓	*	*	*	*	*	*	*	*	*	✓	✓	✓	✓	✓	✓	✓	✓
<i>inside</i>	✓	✓	✓	*	*	*	*	*	*	*	*	*	✓	✓	✓	✓	*	✓	✓	✓
<i>behind</i>	*	✓	✓	*	*	*	*	*	*	*	*	*	✓	✓	✓	✓	*	✓	✓	✓
<i>alongside</i>	✓	✓	✓	*	*	*	*	*	*	*	*	*	✓	✓	*	✓	*	✓	✓	✓
<i>under</i>	✓	✓	✓	*	*	*	*	*	*	*	*	*	✓	✓	✓	✓	*	✓	✓	✓
N.S.E.W.	✓	✓	*	*	*	*	*	*	*	*	*	*	✓	✓	✓	✓	*	✓	✓	✓
<i>instead</i>	✓	✓	*	*	*	*	*	*	*	*	*	*	✓	*	*	*	*	✓	✓	✓
<i>minus</i>	*	*	✓	*	*	*	*	*	*	*	*	*	✓	*	*	*	*	✓	*	*
<i>versus</i>	*	*	✓	*	*	*	*	*	*	*	*	*	✓	*	*	*	*	✓	✓	*
<i>per</i>	*	✓	✓	*	*	*	*	*	*	*	*	*	✓	*	*	*	*	✓	✓	*
<i>gone</i> (BrE)	*	*	✓	*	*	*	*	*	*	*	*	*	*	*	*	*	*	✓	*	*



	A	B	C	D	E	F	G	H	I	J	K	L	M	N	O	P	Q	R	S	T	
<i>since</i> (temporal)	*	✓	✓	✓	*	✓	✓	*	*	✓	*	*	✓	✓	*	*	*	✓	*	✓	
<i>since</i> (non-temporal)	*	*	*	*	*	✓	*	*	*	*	*	*	*	*	*	*	*	*	*	*	✓
<i>as</i> (temporal)	*	*	*	*	*	✓	*	*	*	*	*	*	*	*	*	*	*	*	*	*	✓
<i>as</i> (causative)	*	*	*	*	*	✓	✓	*	*	*	*	*	*	*	*	*	*	*	*	*	✓
<i>on</i> (locative)	*	*	✓	*	*	*	*	*	*	*	*	*	✓	✓	*	*	*	✓	✓	✓	
<i>on</i> (concerning)	*	*	✓	*	*	*	*	*	*	*	*	*	✓	*	*	*	*	✓	*	✓	
<i>on</i> (non-locative)	✓	✓	*	*	*	*	*	*	*	*	*	*	✓	*	✓	*	✓	✓	✓	*	
<i>off</i> (locative)	✓	*	✓	*	*	*	*	*	*	*	*	*	✓	✓	✓	✓	✓	✓	✓	✓	
<i>off</i> (non-locative)	✓	✓	*	*	*	*	*	*	*	*	*	*	✓	*	✓	✓	✓	✓	✓	*	
<i>outside</i> (locative)	✓	✓	✓	*	*	*	*	*	*	*	*	*	✓	✓	✓	✓	*	✓	✓	✓	
<i>outside</i> (exception)	✓	*	*	*	*	*	*	*	*	*	*	*	*	*	*	*	*	*	*	*	✓
<i>in</i> (locative)	✓	✓	✓	*	*	*	*	*	*	*	*	*	✓	✓	✓	✓	✓	✓	✓	✓	
<i>in</i> (non-locative)	*	*	✓	*	✓	*	*	*	*	✓	*	*	✓	*	*	*	✓	✓	*	✓	
<i>that</i> (purposive)	*	*	*	*	*	✓	✓	*	*	*	*	*	*	*	*	*	*	*	*	*	✓
<i>that</i> (empty)	*	*	*	*	*	✓	✓	*	*	*	*	*	✓	✓	*	*	*	✓	*	*	
<i>while</i> (temporal)	*	*	*	*	*	✓	✓	*	*	*	✓	*	*	*	*	*	*	✓	*	✓	
<i>while</i> (concessive)	*	*	*	*	*	✓	*	*	*	*	*	*	*	*	*	*	*	*	*	*	✓
<i>whilst</i> (temporal)	*	*	*	*	*	✓	✓	*	*	*	✓	*	*	*	*	*	*	✓	*	✓	
<i>whilst</i> (concessive)	*	*	*	*	*	*	*	*	*	*	*	*	*	*	*	*	*	*	*	*	✓
<i>apart</i> ('away')	✓	✓	*	*	*	*	*	*	*	*	*	*	*	*	✓	✓	*	✓	✓	✓	
<i>aside</i> ('away')	✓	✓	*	*	*	*	*	*	*	*	*	*	*	*	✓	✓	*	*	✓	✓	
<i>apart</i> (exception)	✓	✓	✓	*	*	*	*	*	*	*	*	*	*	*	*	*	*	✓	*	✓	
<i>aside</i> (exception)	✓	✓	✓	*	*	*	*	*	*	*	*	*	*	*	*	*	*	*	*	*	✓
<i>by</i> (non-locative)	*	✓	✓	*	*	*	*	✓	*	✓	*	*	✓	*	*	*	*	✓	*	✓	
<i>by</i> (locative)	*	✓	✓	*	*	*	*	*	*	*	*	*	✓	✓	✓	✓	*	✓	✓	✓	
<i>at</i>	*	*	✓	*	*	*	*	*	*	*	*	*	✓	✓	*	✓	*	✓	✓	✓	
<i>about</i> (locative)	*	✓	✓	*	*	*	*	*	*	*	*	*	✓	*	*	*	*	✓	*	✓	
<i>about</i> (concerning)	*	*	✓	*	*	*	*	*	*	*	*	*	✓	*	*	*	*	✓	*	✓	
<i>worth</i>	*	*	✓	✓	*	*	*	*	*	*	*	*	✓	*	*	*	*	✓	*	*	
<i>near</i>	✓	✓	✓	*	*	*	*	*	*	*	*	*	✓	✓	*	✓	*	✓	✓	✓	
<i>close</i>	✓	✓	*	*	*	*	*	*	*	*	*	*	✓	✓	*	✓	*	✓	✓	✓	
<i>far</i>	✓	✓	*	*	*	*	*	*	*	*	*	*	✓	✓	*	✓	*	✓	✓	✓	

Appendix 6. Classes of precomps

CLASS 1: ABOUT (loc)

A	can have NP complement	+	She looked <i>about the room</i> , and then back at him. [BNC: C8S 768]
B	can have what is widely classified as prepositional complement	-	
C	can have no complement	+	... as if I was holding the thought in my hands, looking at it, turning it <i>about</i> [___]. [BNC: A08 2936]
D	can have adverbial complement	-	
E	can have <i>that</i> -clause complement	-	
F	can have <i>that</i> -less clause complement	-	
G	can have topicalisation	-	
H	can have small clause complement: overt subject & not <i>-ing</i> predicate	-	
I	can have small clause complement: raised subject & <i>-ing</i> predicate	-	
J	can have small clause complement: raised subj & not <i>-ing</i> predicate	-	
K	can occur with complement with correlative <i>or</i>	-	
L	can occur with measure phrase	-	
M	can occur with <i>right/straight</i> modifier	-	
N	can undergo particle shift	-	
O	can be predicative complement in RAISING constructions	+	The movement <i>was about</i> the room. [Google Web]
P	can be non-predicative modifier	+	She was moving <i>about the room now</i> ... [BNC: A73 1660]

CLASS 2: ADJACENT

A	can have NP complement	+	The claim a tower provided with means <i>adjacent the lower end</i> thereof for supporting it within a vertical open shaft of the structure [COCA: 2009]
B	can have what is widely classified as prepositional complement	+	To the rear of the main block, <i>adjacent to the old railway bridge</i> , is a wide stone arch which was part of the installation. [BNC: ANC 164]
C	can have no complement	-	
D	can have adverbial complement	-	
E	can have <i>that</i> -clause complement	-	
F	can have <i>that</i> -less clause complement	-	
G	can have topicalisation	-	
H	can have small clause complement: overt subject & not <i>-ing</i> predicate	-	
I	can have small clause complement: raised subject & <i>-ing</i> predicate	-	
J	can have small clause complement: raised subj & not <i>-ing</i> predicate	-	
K	can occur with complement with correlative <i>or</i>	-	
L	can occur with measure phrase	-	
M	can occur with <i>right/straight</i> modifier	+	A part of their brain has extended out <i>right adjacent</i> to their limbic system. [COCA: 2013]
N	can undergo particle shift	-	



O	can be predicative complement in RAISING constructions	+	These <i>are adjacent</i> to the Globe site. [BNC: A59 736]
P	can be non-predicative modifier	+	<i>Adjacent to the Winery</i> you will find a selection of Period Oak & Country Furniture ... [BNC: B3K 1663]

CLASS 3: ADRIFT

A	can have NP complement	-	
B	can have what is widely classified as prepositional complement	-	
C	can have no complement	+	At the second he had a bogey five to James's three and was five strokes <i>adrift</i> . [BNC A1N 127]
D	can have adverbial complement	-	
E	can have <i>that</i> -clause complement	-	
F	can have <i>that</i> -less clause complement	-	
G	can have topicalisation	-	
H	can have small clause complement: overt subject & not <i>-ing</i> predicate	-	
I	can have small clause complement: raised subject & <i>-ing</i> predicate	-	
J	can have small clause complement: raised subj & not <i>-ing</i> predicate	-	
K	can occur with complement with correlative <i>or</i>	-	
L	can occur with measure phrase	-	
M	can occur with <i>right/straight</i> modifier	-	
N	can undergo particle shift	-	
O	can be predicative complement in RAISING constructions	+	The seamen are <i>adrift</i> in lifeboats, seventeen hundred miles off the Falkland Islands. [BNC K21 100]
P	can be non-predicative modifier	-	

Adrift has been listed as a “preposition” in Pullum and Huddleston (2002: 614). Its inclusion among the prepositions is inspired by the fact that it, like other prepositions such as *aground*

and *ahead*, ‘... contain[s] the prefix *a*, which originates historically in a form of the preposition *on*. They are the result of fusion of the preposition with its complement’ (Pullum & Huddleston, 2002: 614). This is unconvincing, since *adrift* seems to have syntactic features closer to adjectives, such as *awake* and *asleep*, than prepositions as it can occur in raising constructions as ordinary adjectives and cannot function as non-predicative modifier. It differs from adjectives, however, in that it does not seem to occur in constructions like **He wentadrift* but it does in *set heradrift in a boat* [BNC CAC 885] which it shares with other adjectives such as *free* as in *Not only does it set you free to live in the present but you had better start enjoying it* [BNC A7D 790].

CLASS 4: AGO

A	can have NP complement	+	There are not the chances around these days as there were some years <i>ago</i> . [BNC: A06 2156]
B	can have what is widely classified as prepositional complement	-	
C	can have no complement	-	
D	can have adverbial complement	-	
E	can have <i>that</i> -clause complement	-	
F	can have <i>that</i> -less clause complement	-	
G	can have topicalisation	-	
H	can have small clause complement: overt subject & not <i>-ing</i> predicate	-	
I	can have small clause complement: raised subject & <i>-ing</i> predicate	-	
J	can have small clause complement: raised subj & not <i>-ing</i> predicate	-	
K	can occur with complement with correlative <i>or</i>	-	
L	can occur with measure phrase	-	<i>Fifty years ago</i> , they were in closer touch. [BNC: A04 82]



M	can occur with <i>right/straight</i> modifier	-	
N	can undergo particle shift	-	
O	can be predicative complement in RAISING constructions	+	There are not the chances around these days as there were some years <i>ago</i> . [BNC: A06 2156]
P	can be non-predicative modifier	+	Fifty years <i>ago</i> , they were in closer touch. [BNC: A04 82]

CLASS 5: AHEAD, N.S.E.W.

A	can have NP complement	-	
B	can have what is widely classified as prepositional complement	+	Berger said: 'He made it to the first corner <i>ahead of me</i> and I tried to hang on.' [BNC: A1N 69]
C	can have no complement	+	Instead, you should simply level out and land <i>ahead</i> [___]. [BNC: A0H 688]
D	can have adverbial complement	-	
E	can have <i>that</i> -clause complement	-	
F	can have <i>that</i> -less clause complement	-	
G	can have topicalisation	-	
H	can have small clause complement: overt subject & not <i>-ing</i> predicate	-	
I	can have small clause complement: raised subject & <i>-ing</i> predicate	-	
J	can have small clause complement: raised subj & not <i>-ing</i> predicate	-	
K	can occur with complement with correlative <i>or</i>	-	
L	can occur with measure phrase	+	... and on the way home I walked stiffly <i>three yards ahead</i> of her. [BNC: A5K 215]
M	can occur with <i>right/straight</i> modifier	+	Farah can run at a slower cadence than maybe the dude that's <i>right ahead</i> of him ... [COCA: 2013]
N	can undergo particle shift	-	
O	can be predicative complement in RAISING constructions	+	Benjamin <i>is ahead</i> of us. [COCA: 2017]
P	can be non-predicative modifier	+	The Tories had again moved <i>ahead in the polls</i> at the start of September. [BNC: A66 292]

CLASS 6: ALBEIT

A	can have NP complement	-	
B	can have what is widely classified as prepositional complement	-	
C	can have no complement	-	
D	can have adverbial complement	-	
E	can have <i>that</i> -clause complement	+	The conversion of one kind of cocaine to another was production of a substance ‘by other means’ <i>albeit <u>that the same generic term, cocaine, covered both substances.</u></i> [BNC: FBK 822]
F	can have <i>that</i> -less clause complement	+	Friday was bright <i>albeit <u>the wind was somewhat stronger and it was colder.</u></i> [BNC: GXA 975]
G	can have topicalisation	+	<i>Albeit <u>the solution he understands,</u></i> John cannot solve the problem. [Q]
H	can have small clause complement: overt subject & not <i>-ing</i> predicate	-	
I	can have small clause complement: raised subject & <i>-ing</i> predicate	+	Left to itself a vine would carpet the land in every direction, <i>albeit <u>making haphazard progress.</u></i> [BNC C8M 1263]
J	can have small clause complement: raised subj & not <i>-ing</i> predicate	+	Gooch and Atherton created a developing sense of well-being, <i>albeit <u>fragile.</u></i> [BNC EB3 1137]
K	can occur with complement with correlative <i>or</i>	-	
L	can occur with measure phrase	-	



M	can occur with <i>right/straight</i> modifier	-	
N	can undergo particle shift	-	
O	can be predicative complement in RAISING constructions	-	
P	can be non-predicative modifier	+	Jaguar's classy convertibles start at £41,200, <i>albeit with V12 power</i> . [BNC: A38 125]

CLASS 7: ALLOWING

A	can have NP complement	-	
B	can have what is widely classified as prepositional complement	-	
C	can have no complement	-	
D	can have adverbial complement	-	
E	can have <i>that</i> -clause complement	+	
F	can have <i>that</i> -less clause complement	+	
F*	infinitival <i>for</i> complement	+	more complex analysis method accounts for dependencies among student scores due to school membership, <i>allowing for valid inferences to be drawn about relationships between student outcomes and school-level predictors</i> ... [COCA 2012]
G	can have topicalisation	+	<i>Allowing that his van</i> John can drive, they can get the goods to the south very easily. [Q]
H	can have small clause complement: overt subject & not <i>-ing</i> predicate	-	
I	can have small clause complement: raised subject & <i>-ing</i> predicate	-	
J	can have small clause complement: raised	-	



	subj & not <i>-ing</i> predicate		
K	can occur with complement with correlative <i>or</i>	-	
L	can occur with measure phrase	-	
M	can occur with <i>right/straight</i> modifier	-	
N	can undergo particle shift	-	
O	can be predicative complement in RAISING constructions	+	For many people, the biggest challenge in getting in sync with these rhythms <i>is allowing</i> that sync to happen rather than forcing it. [COCA 1996]
P	can be non-predicative modifier	+	They spurred each other on, <i>allowing the action and the words to flow naturally</i> . [BNC A0P 1546]

CLASS 8: ALTHOUGH, *though*, *while* (concessive), *whilst* (concessive)

A	can have NP complement	-	
B	can have what is widely classified as prepositional complement	-	
C	can have no complement	+	<i>Although</i> [___], at that moment I could have done with a little less myself. [BNC: A0D 1707]
D	can have adverbial complement	-	
E	can have <i>that</i> -clause complement	-	
F	can have <i>that</i> -less clause complement	+	<i>Although</i> an agent may be very impressed by the talent he sees, there are practical difficulties which affect how much agents can do for young actors. [BNC: A06 1474]
G	can have topicalisation	+	<i>Although</i> <u>the solution he understands</u> , he cannot solve the problem. [Q]
H	can have small clause complement: overt subject & not <i>-ing</i> predicate	-	
I	can have small clause complement: raised subject & <i>-ing</i> predicate	+	<i>Although</i> <u>recognising that many such 'Go, No-Go' decisions are made after a brief examination by one or two executives</u> , he argues that more 'scientific' or 'realistic' comparative methods of assessment should be used. [BNC A60 958]
J	can have small clause complement: raised subj & not <i>-ing</i> predicate	+	<i>Although</i> <u>nearly exhausted</u> , we passed on. (Pullum & Huddleston, 2002: 640)



K	can occur with complement with correlative <i>or</i>	-	
L	can occur with measure phrase	-	
M	can occur with <i>right/straight</i> modifier	-	
N	can undergo particle shift	-	
O	can be predicative complement in RAISING constructions	-	
P	can be non-predicative modifier	+	<i>Although <u>ACET</u>, like any charity, does not have the power to release you from the agreement it is likely to be sympathetic. [BNC: A01 305]</i>



CLASS 9: AMID, *among*, *beside*, *against*, *during*, *at*

A	can have NP complement	+	... were still under stress " and trying to get their own records straight <i>amid continuing investigations</i> by authorities, said Alex Crosby, a medical epidemiologist ... [COCA: 1992]
B	can have what is widely classified as prepositional complement	-	
C	can have no complement	-	
D	can have adverbial complement	-	
E	can have <i>that</i> -clause complement	-	
F	can have <i>that</i> -less clause complement	-	
G	can have topicalisation	-	
H	can have small clause complement: overt subject & not <i>-ing</i> predicate	-	
I	can have small clause complement: raised subject & <i>-ing</i> predicate	-	
J	can have small clause complement: raised subj & not <i>-ing</i> predicate	-	
K	can occur with complement with correlative <i>or</i>	-	
L	can occur with measure phrase	-	



M	can occur with <i>right/straight</i> modifier	+	... were still under stress and trying to get their own records <i>straight amid</i> continuing investigations by authorities ... [COCA: 2003]
N	can undergo particle shift	-	
O	can be predicative complement in RAISING constructions	+	yet here we <i>are amid</i> these real riches and most people are miserable and peevish. [BNC: B1F 1010]
P	can be non-predicative modifier	+	I stood <i>amid a gaggle of laughing students in frozen silence</i> and read the list over and over again. [BNC: A0F 12]

CLASS 10: APART (“away”), *aside* (“away”)

A	can have NP complement	-	
B	can have what is widely classified as prepositional complement	+	Before then, he had never spent a night <i>apart from his extended family</i> . [COCA: 2017]
C	can have no complement	+	The pretense fell <i>apart</i> [___]. [BNC: A0U 2364]
D	can have adverbial complement	-	
E	can have <i>that</i> -clause complement	-	
F	can have <i>that</i> -less clause complement	-	
G	can have topicalisation	-	
H	can have small clause complement: overt subject & not <i>-ing</i> predicate	-	
I	can have small clause complement: raised subject & <i>-ing</i> predicate	-	
J	can have small clause complement: raised subj & not <i>-ing</i> predicate	-	
K	can occur with complement with correlative <i>or</i>	-	
L	can occur with measure phrase	+	They were about <i>five yards apart</i> and he was just deciding they weren't anything to do with him when they both took out pistols. [BNC: H86 941]
M	can occur with <i>right/straight</i> modifier	+	I mean, everything's got to work or this whole thing will fall <i>right apart</i> . [COCA: 2009]
N	can undergo particle shift	-	



O	can be predicative complement in RAISING constructions	+	And always, when we <i>were apart</i> , I kept bringing you beside me in my imagination, in the poems I was writing all alone ... [BNC: AC6 1031]
P	can be non-predicative modifier	-	

CLASS 11: APART (“except”), *aside* (“except”)

A	can have NP complement	+	<i>This advantage apart</i> , the circuit is of limited practical use as the efficiency is not too high due to all the diode drops. [BNC A19 1219]
B	can have what is widely classified as prepositional complement	+	<i>Apart from</i> the 4-SUBS, traffic levels meant there was little chance for stock to fall out of the bottom of the cascade. [BNC A11 1611]
C	can have no complement	-	
D	can have adverbial complement	-	
E	can have <i>that</i> -clause complement	-	
F	can have <i>that</i> -less clause complement	-	
G	can have topicalisation	-	
H	can have small clause complement: overt subject & not <i>-ing</i> predicate	-	
I	can have small clause complement: raised subject & <i>-ing</i> predicate	-	
J	can have small clause complement: raised subj & not <i>-ing</i> predicate	-	
K	can occur with complement with correlative <i>or</i>	-	
L	can occur with measure phrase	-	
M	can occur with <i>right/straight</i> modifier	-	
N	can undergo particle shift	-	
O	can be predicative complement in RAISING constructions	+	



P	can be non-predicative modifier	+	<i>Apart from art criticism and art history, there exist several other types of writing about art. [BNC A04 115]</i>
---	---------------------------------	---	--

CLASS 12: ASHORE, *aground, abroad, home, here, there*

A	can have NP complement	-	
B	can have what is widely classified as prepositional complement	-	
C	can have no complement	+	She'd say, moreover, that you could always get out of a boat and go <i>ashore</i> [___], but from that height you could only crash. [BNC: A05 712]
D	can have adverbial complement	-	
E	can have <i>that</i> -clause complement	-	
F	can have <i>that</i> -less clause complement	-	
G	can have topicalisation	-	
H	can have small clause complement: overt subject & not <i>-ing</i> predicate	-	
I	can have small clause complement: raised subject & <i>-ing</i> predicate	-	
J	can have small clause complement: raised subj & not <i>-ing</i> predicate	-	
K	can occur with complement with correlative <i>or</i>	-	
L	can occur with measure phrase	-	
M	can occur with <i>right/straight</i> modifier	+	a low-key fishing operation on the west side of the lake, <i>straight ashore</i> from the north end of the crack dividing the ice in St. Albin's Bay ... [COCA: 2013]



N	can undergo particle shift	-	
O	can be predicative complement in RAISING constructions	+	I've <i>been ashore</i> , enjoying a short break to which I was perfectly entitled,' she flung back at him. [BNC: JXW 3571]
P	can be non-predicative modifier	+	His body was washed <i>ashore</i> on what was to become Omaha Beach. [BNC: A67 911]

CLASS 13: AWAY

A	can have NP complement	-	
B	can have what is widely classified as prepositional complement	+	... I soon got <i>away from it</i> . [BNC: A08 398]
C	can have no complement	+	Nearly all the stone steps in the first flight up to the half-landing were broken, with jagged edges where bits of tread had fallen <i>away</i> [___]. [BNC: A05 359]
D	can have adverbial complement	-	
E	can have <i>that</i> -clause complement	-	
F	can have <i>that</i> -less clause complement	-	
G	can have topicalisation	-	
H	can have small clause complement: overt subject & not <i>-ing</i> predicate	-	
I	can have small clause complement: raised subject & <i>-ing</i> predicate	-	
J	can have small clause complement: raised subj & not <i>-ing</i> predicate	-	
K	can occur with complement with correlative <i>or</i>	-	
L	can occur with measure phrase	+	Then the stance would only be <i>ten feet away</i> ... [BNC: A15 596]
M	can occur with <i>right/straight</i> modifier	+	It was Marshall who took the game <i>right away</i> from England ... [BNC: ABR 635]



N	can undergo particle shift	+	(i) about 1,000 feet you should put <i>away</i> <u>the maps</u> ... [BNC: A0H 1050] (ii) ... if they do send in dragoons with guns to take <u>the men</u> <i>away</i> — we are helpless ... [BNC: A0N 1985]
O	can be predicative complement in RAISING constructions	+	While I <u>was</u> <i>away</i> , it must have rained. [BNC: A0R 2991]
P	can be non-predicative modifier	+	<i>Away from the hotel</i> there's plenty to discover as you ramble or cycle around this little island (cars are not allowed). [BNC: BPF 2017]

CLASS 14: BAR, *as to*, *as for*, *come*, *absent*, *besides* ("except")

A	can have NP complement	+	Surely, it's over, <i>bar</i> the paperwork. [BNC: GWB 2581]
B	can have what is widely classified as prepositional complement	-	
C	can have no complement	-	
D	can have adverbial complement	-	
E	can have <i>that</i> -clause complement	-	
F	can have <i>that</i> -less clause complement	-	
G	can have topicalisation	-	
H	can have small clause complement: overt subject & not <i>-ing</i> predicate	-	
I	can have small clause complement: raised subject & <i>-ing</i> predicate	-	
J	can have small clause complement: raised subj & not <i>-ing</i> predicate	-	
K	can occur with complement with correlative <i>or</i>	-	
L	can occur with measure phrase	-	
M	can occur with <i>right/straight</i> modifier	-	
N	can undergo particle shift	-	
O	can be predicative complement in RAISING constructions	-	
P	can be non-predicative modifier	+	Surely, it's over, <i>bar</i> the paperwork. [BNC: GWB 2581]

CLASS 15: BEARING, *having*

A	can have NP complement	-	
B	can have what is widely classified as prepositional complement	-	
C	can have no complement	-	
D	can have adverbial complement	-	
E	can have <i>that</i> -clause complement	-	
F	can have <i>that</i> -less clause complement	-	
G	can have topicalisation	-	
H	can have small clause complement: overt subject & not <i>-ing</i> predicate	-	
I	can have small clause complement: raised subject & <i>-ing</i> predicate	-	
J	can have small clause complement: raised subj & not <i>-ing</i> predicate	+	<i>Bearing in mind that it takes approximately 12 weeks from planting to flowering</i> , it is possible to grow bulbs of many species and varieties to flower at the same time ... [BNC: A0G 684]
K	can occur with complement with correlative <i>or</i>	-	
L	can occur with measure phrase	-	
M	can occur with <i>right/straight</i> modifier	-	
N	can undergo particle shift	-	



O	can be predicative complement in RAISING constructions	+	And we should always sort of <i>be bearing</i> in mind how we were representing that entity or what we were doing for that ... [COCA 2016]
P	can be non-predicative modifier	+	<i>Bearing in mind the need for Poland and Hungary to reach rapid agreement with international financial institutions</i> , the Council (of ministers) recognises ... [BNC: A28 363]

CLASS 16: BECAUSE

A	can have NP complement	-	
B	can have what is widely classified as prepositional complement	+	To be eligible for ACET Home Care you must be HIV positive and require assistance <i>because of this</i> . [BNC: A01 486]
C	can have no complement	-	
D	can have adverbial complement	-	
E	can have <i>that</i> -clause complement	-	
F	can have <i>that</i> -less clause complement	+	You can also find it hard to remember things, <i>because germs are multiplying in your brain</i> . [BNC: A01 16]
G	can have topicalisation	+	<i>Because strict commands like these, he had to obey</i> , he hated being in the army. [Q]
H	can have small clause complement: overt subject & not <i>-ing</i> predicate	-	
I	can have small clause complement: raised subject & <i>-ing</i> predicate	-	
J	can have small clause complement: raised subj & not <i>-ing</i> predicate	-	
K	can occur with complement with correlative <i>or</i>	-	
L	can occur with measure phrase	-	
M	can occur with <i>right/straight</i> modifier	-	
N	can undergo particle shift	-	
O	can be predicative complement in RAISING constructions	+	Some of the presence <i>is because</i> of its elegant styling. [COCA 2017]



P	can be non-predicative modifier	+	He concentrated on it <i>because he loved it ...</i> [BNC: A04 656]
---	---------------------------------	---	--



CLASS 17: BEFORE, *after*

A	can have NP complement	+	The Deed of Covenant has to be filled in corrected <i>before a payment</i> is made. [BNC: A01 344]
B	can have what is widely classified as prepositional complement	-	
C	can have no complement	+	More autocratic and more absentee than <i>before</i> [___]. [BNC: A06 2370]
D	can have adverbial complement	-	
E	can have <i>that</i> -clause complement	-	
F	can have <i>that</i> -less clause complement	+	Owen, seven years younger, was killed one week <i>before the war ended</i> . [BNC: A06 1136]
G	can have topicalisation	-	
H	can have small clause complement: overt subject & not <i>-ing</i> predicate	-	
I	can have small clause complement: raised subject & <i>-ing</i> predicate	+	Just <i>before leaving to attend the Conference itself</i> , Patrick fitted in a live broadcast on Radio 4's 'Today Programme'. [BNC: A00 210]
J	can have small clause complement: raised subj & not <i>-ing</i> predicate	-	
K	can occur with complement with correlative <i>or</i>	-	
L	can occur with measure phrase	+	<i>Three days before</i> she came back, I cleaned the flat ... [BNC: A0L 1243]
M	can occur with <i>right/straight</i> modifier	+	You know it's busy getting things <i>straight before</i> harvest. [BNC: AC4 139]
N	can undergo particle shift	-	



O	can be predicative complement in RAISING constructions	+	That <i>is</i> <i>before</i> the fête begins. [BNC: A18 1191]
P	can be non-predicative modifier	+	They make millions of viruses, <i>before they too die off</i> . [BNC: A01 33]

CLASS 18: BEHIND, *beyond, below, above, underneath, beneath, within, aboard, by* (loc),
opposite

A	can have NP complement	+	However, other prominent prisoners of conscience remain <i>behind bars</i> . [BNC: A03 62]
B	can have what is widely classified as prepositional complement	-	
C	can have no complement	+	We seemed to have left the world <i>behind</i> [___]. [BNC: A15 375]
D	can have adverbial complement	-	
E	can have <i>that</i> -clause complement	-	
F	can have <i>that</i> -less clause complement	-	
G	can have topicalisation	-	
H	can have small clause complement: overt subject & not <i>-ing</i> predicate	-	
I	can have small clause complement: raised subject & <i>-ing</i> predicate	-	
J	can have small clause complement: raised subj & not <i>-ing</i> predicate	-	
K	can occur with complement with correlative <i>or</i>	-	
L	can occur with measure phrase	+	Biasion won the first three of the morning's special stages but then lost valuable seconds when he spun and lies fourth overall, <i>two minutes behind</i> Fiorio. [BNC: A4P 436]



M	can occur with <i>right/straight</i> modifier	+	Gene was playing <i>right behind</i> us with Max Faulkner and Harry Bradshaw, I think, and he got his famous hole-in-one. [BNC: ASA 1122]
N	can undergo particle shift	-	
O	can be predicative complement in RAISING constructions	+	Unfortunately, they <i>were behind</i> schedule and I had to make do with a curry-house scene. [BNC: A2G 110]
P	can be non-predicative modifier	+	I shut the door <i>behind him</i> and locked it. [BNC: A08 3108]

CLASS 19: BETWEEN, *throughout*, *all over*

A	can have NP complement	+	You can be infected for <i>between</i> <u>10–15 years</u> without realising it. [BNC: A00 16]
B	can have what is widely classified as prepositional complement	–	
C	can have no complement	+	And Lucy's silky warm skin all along her, arms wrapped round each other, so close that nothing could come <i>between</i> [___]. [BNC A0L 214]
D	can have adverbial complement	–	
E	can have <i>that</i> -clause complement	–	
F	can have <i>that</i> -less clause complement	–	
G	can have topicalisation	–	
H	can have small clause complement: overt subject & not <i>-ing</i> predicate	–	
I	can have small clause complement: raised subject & <i>-ing</i> predicate	–	
J	can have small clause complement: raised subj & not <i>-ing</i> predicate	–	
K	can occur with complement with correlative <i>or</i>	–	
L	can occur with measure phrase	–	
M	can occur with <i>right/straight</i> modifier	+	We'll make it <u><i>right</i></u> <i>between us</i> . [BNC: FAB 3640]
N	can undergo particle shift	–	



O	can be predicative complement in RAISING constructions	+	... it is probable that there <i>are between</i> 40–60,000 people actually infected. [BNC: A00 20]
P	can be non-predicative modifier	+	<i>Between 1984 and 1986</i> those with AIDS died on average some ten months after diagnosis. [BNC: A00 253]

CLASS 20: CONSIDERING, *assuming*

A	can have NP complement	+	<i>Considering <u>the success of Flexible Friends</u>, it's a bit strange that ... [BNC: A15 1148]</i>
B	can have what is widely classified as prepositional complement	-	
C	can have no complement	-	
D	can have adverbial complement	-	
E	can have <i>that</i> -clause complement	+	<i>Considering <u>that this was written at a time when Pound's reputation was eclipsed as Eliot's rose towards the zenith</u>, the generosity of this essay, ... admirable. [BNC: A1B 623]</i>
F	can have <i>that</i> -less clause complement	+	<i>Ironically, <u>considering they bought mainly by people who don't need to ask the price</u>, Armani considers that [ABNC: A7P 211]</i>
G	can have topicalisation	+	<i>Considering <u>that the solution he introduces</u>, he is unable to see how it works. [Q]</i>
H	can have small clause complement: overt subject & not <i>-ing</i> predicate	-	
I	can have small clause complement: raised subject & <i>-ing</i> predicate	-	
J	can have small clause complement: raised subj & not <i>-ing</i> predicate	-	
K	can occur with complement with correlative <i>or</i>	-	
L	can occur with measure phrase	-	



M	can occur with <i>right/straight</i> modifier	-	
N	can undergo particle shift	-	
O	can be predicative complement in RAISING constructions	+	Mr Beeton <i>is considering</i> a range of options to embellish their presentation without substituting fiction for reality. [BNC: A21 28]
P	can be non-predicative modifier	+	<i>Considering that so many gliders are flown across country on every possible soaring day</i> , the accident rate for gliding is extremely low. [BNC: A0H 9]

CLASS 21: CONTRARY, *counter*, *exclusive*, *pursuant*, *subsequent*, *previous*, *preparatory*, *preliminary*, *prior*, *outside* (“except”), *further* (reference), *consequent*, *unknown(st)*, *irrespective*, *apropos*, *according*, *due* (reason), *turning*, *pertaining*, *thanks*, *owing*

A	can have NP complement	–	
B	can have what is widely classified as prepositional complement	+	<i>Contrary to her usual habit</i> , she ran for a motorbike messenger. [BNC: A6J 1722]
C	can have no complement	–	
D	can have adverbial complement	–	
E	can have <i>that</i> -clause complement	–	
F	can have <i>that</i> -less clause complement	–	
G	can have topicalisation	–	
H	can have small clause complement: overt subject & not <i>-ing</i> predicate	–	
I	can have small clause complement: raised subject & <i>-ing</i> predicate	–	
J	can have small clause complement: raised subj & not <i>-ing</i> predicate	–	
K	can occur with complement with correlative <i>or</i>	–	
L	can occur with measure phrase	–	
M	can occur with <i>right/straight</i> modifier	–	



N	can undergo particle shift	-	
O	can be predicative complement in RAISING constructions	+	This <u>was</u> <i>contrary</i> to the opinion of the world and society which thought of him as a boffin. [BNC: A68 1813]
P	can be non-predicative modifier	+	<i>Contrary to reports in Paris last week</i> , government investigators working at the central police laboratory here have ruled out the presence of the Czechoslovak ... [BNC: A2M 230]

CLASS 22: COUNTING, *respecting, failing, barring, excluding, including, pending, regarding, concerning*

A	can have NP complement	+	<i>Counting pensioners and children</i> , 14m savers should not be paying tax, but have to under current legislation. [BNC: ABF 1880]
B	can have what is widely classified as prepositional complement	-	
C	can have no complement	-	
D	can have adverbial complement	-	
E	can have <i>that</i> -clause complement	-	
F	can have <i>that</i> -less clause complement	-	
G	can have topicalisation	-	
H	can have small clause complement: overt subject & not <i>-ing</i> predicate	-	
I	can have small clause complement: raised subject & <i>-ing</i> predicate	-	
J	can have small clause complement: raised subj & not <i>-ing</i> predicate	-	
K	can occur with complement with correlative <i>or</i>	-	
L	can occur with measure phrase	-	
M	can occur with <i>right/straight</i> modifier	-	
N	can undergo particle shift	-	



O	can be predicative complement in RAISING constructions	+	We shall never know whether he <i>was counting</i> Mark Twain. [BNC: ACS 1110]
P	can be non-predicative modifier	+	<i>Counting the Treasurer</i> , this gives attendances of 41, six and two, which do indeed sum to 49. [BNC: AAV 658]

CLASS 23: EXCEPT, *excepting*

A	can have NP complement	+	The HMI does not inspect universities, <i>except teacher training departments</i> , by invitation. [BNC: A30 463]
B	can have what is widely classified as prepositional complement	+	Agassiz discouraged the use of books, <i>except for research work</i> . [BNC: A04 947]
C	can have no complement	-	
D	can have adverbial complement	-	
E	can have <i>that</i> -clause complement	+	I don't know the name or address <i>except that it is a club of some sort</i> . [BNC A6V 318]
F	can have <i>that</i> -less clause complement	+	I wouldn't get married at all <i>except I need to work over there</i> . [BNC: A0U 468]
G	can have topicalisation	+	He hates his students; <i>except Nancy he adores</i> . [Q]
H	can have small clause complement: overt subject & not <i>-ing</i> predicate	-	
I	can have small clause complement: raised subject & <i>-ing</i> predicate	-	
J	can have small clause complement: raised subj & not <i>-ing</i> predicate	+	<i>Except in small quantities or special cases</i> , money now has to be raised through debt. [BNC: ABJ 3924]
K	can occur with complement with correlative <i>or</i>	-	
L	can occur with measure phrase	-	
M	can occur with <i>right/straight</i> modifier	-	
N	can undergo particle shift	-	



O	can be predicative complement in RAISING constructions	+	what measures could that <i>be except</i> for starting a war? [COCA: 1990]
P	can be non-predicative modifier	+	His hands were manacled behind his back <i>except when he ate or slept</i> . [BNC: A03 549]

CLASS 24: FOR FEAR, *but, in the event, on the basis, on the ground(s), to the effect*

A	can have NP complement	-	
B	can have what is widely classified as prepositional complement	+	It also explains why Mr Morita hastily withdrew his chapters of the book, <i>for fear <u>of the damage it might do to Sony's sales.</u></i> [BNC ABH 499]
C	can have no complement	-	
D	can have adverbial complement	-	
E	can have <i>that</i> -clause complement	+	We couldn't have gone in daylight <i>for fear <u>that Dad would be spotted and reported to the relief officers</u></i> ... [BNC CDM 2241]
F	can have <i>that</i> -less clause complement	+	Many of the PAN's traditional supporters appeared to abandon the party to support Salinas <i>for fear <u>the left might win.</u></i> [BNC A1W 52]
G	can have topicalisation	+	I was never allowed to do anything <i>for fear <u>that my hands, it might spoil.</u></i> [Q]
H	can have small clause complement: overt subject & not <i>-ing</i> predicate	-	
I	can have small clause complement: raised subject & <i>-ing</i> predicate	-	
J	can have small clause complement: raised subj & not <i>-ing</i> predicate	-	
K	can occur with complement with correlative <i>or</i>	-	
L	can occur with measure phrase	-	
M	can occur with <i>right/straight</i> modifier	-	
N	can undergo particle shift	-	



O	can be predicative complement in RAISING constructions	+	... my lack of close affection could have <i>been for fear</i> that this baby would die as well. The first year was so fragile that [COCA 2008]
P	can be non-predicative modifier	+	Jane nodded, afraid to speak <i>for fear of damming the flow</i> . [BNC ABW 1647]

CLASS 25: FROM

A	can have NP complement	+	The chance of getting infected <i>from a pint of blood</i> is less than 1 in a million. [BNC: A01 26]
B	can have what is widely classified as prepositional complement	-	
C	can have no complement	-	
D	can have adverbial complement	-	
E	can have <i>that</i> -clause complement	-	
F	can have <i>that</i> -less clause complement	-	
G	can have topicalisation	-	
H	can have small clause complement: overt subject & not <i>-ing</i> predicate	-	
I	can have small clause complement: raised subject & <i>-ing</i> predicate	+	Every educator has a personal story to tell <i>from working in our home care teams</i> . [BNC: A02 68]
J	can have small clause complement: raised subj & not <i>-ing</i> predicate	-	
K	can occur with complement with correlative <i>or</i>	-	
L	can occur with measure phrase	-	
M	can occur with <i>right/straight</i> modifier	+	The general situation had been most unsatisfactory right <i>from the start in 1917</i> . [BNC: A64 359]
N	can undergo particle shift	-	
O	can be predicative complement in RAISING constructions	+	The first speech <i>is from</i> Shakespeare and it's taken from the Chorus in Henry ... [BNC: A06 2103]



P	can be non-predicative modifier	+	In consequence of his success, mills using both stones and rollers were built in Britain <i>from the 1860s</i> . [BNC: A79 953]
---	---------------------------------	---	---

CLASS 26: GIVEN, *granted, for all*

A	can have NP complement	+	<i>Given <u>the changes in the film industry worldwide</u>, do critics have an influence in determining box office, taste and value? [BNC: A0E 533]</i>
B	can have what is widely classified as prepositional complement	-	
C	can have no complement	-	
D	can have adverbial complement	-	
E	can have <i>that</i> -clause complement	+	<i>... <u>given that prices have already been set and cannot be changed</u>, what will happen to real output? [BNC: H9M 1101]</i>
F	can have <i>that</i> -less clause complement	+	<i>Given <u>what has happened in Britain</u>, certain enterprises could lend themselves to being sold to the Polish public ... [BNC: AAJ 262]</i>
G	can have topicalisation	+	<i>Given <u>that the solution he introduces</u>, he is unable to see how it works. [Q]</i>
H	can have small clause complement: overt subject & not <i>-ing</i> predicate	-	
I	can have small clause complement: raised subject & <i>-ing</i> predicate	-	
J	can have small clause complement: raised subj & not <i>-ing</i> predicate	-	
K	can occur with complement with correlative <i>or</i>	-	
L	can occur with measure phrase	-	



M	can occur with <i>right/straight</i> modifier	-	
N	can undergo particle shift	-	
O	can be predicative complement in RAISING constructions	-	
P	can be non-predicative modifier	+	<i>Given <u>their prime location in the centre of towns ...</u>, Georgian coaching inns are frequently prime targets for refurbishment. [BNC: A0B 230]</i>

CLASS 27: IF (interrogative)

A	can have NP complement	-	
B	can have what is widely classified as prepositional complement	-	
C	can have no complement	-	
D	can have adverbial complement	-	
E	can have <i>that</i> -clause complement	-	
F	can have <i>that</i> -less clause complement	+	She could not decide <i>if this was something she cared about or not</i> . [BNC ADS 1626]
G	can have topicalisation	+	You should decide <i>if the red car</i> you need to sell. [Q]
H	can have small clause complement: overt subject & not <i>-ing</i> predicate	-	
I	can have small clause complement: raised subject & <i>-ing</i> predicate	-	
J	can have small clause complement: raised subj & not <i>-ing</i> predicate	-	
K	can occur with complement with correlative <i>or</i>	+	She could not decide <i>if this was something she cared about or not</i> . [BNC ADS 1626]
L	can occur with measure phrase	-	
M	can occur with <i>right/straight</i> modifier	-	
N	can undergo particle shift	-	
O	can be predicative complement in RAISING constructions	-	
P	can be non-predicative modifier	-	

CLASS 28: IN (non-loc)

A	can have NP complement	+	Even if historians are specifically interested <i>in form</i> , it is likely to be the history of forms ... [BNC A04 137]
B	can have what is widely classified as prepositional complement	-	
C	can have no complement	-	
D	can have adverbial complement	-	
E	can have <i>that</i> -clause complement	+	There is a further constraint <i>in that the Ministry of Defence will keep a watchful eye on any potential partner or owner</i> . [BNC: A1S 194]
F	can have <i>that</i> -less clause complement	-	
G	can have topicalisation	+	I regret any remark <i>in that you, it upsets</i> . [Q]
H	can have small clause complement: overt subject & not <i>-ing</i> predicate	-	
I	can have small clause complement: raised subject & <i>-ing</i> predicate	+	Your Team has been invaluable <i>in providing psychological as well as practical support for these patients which have been grossly lacking through the conventional channels</i> . [BNC: A01 584]
J	can have small clause complement: raised subj & not <i>-ing</i> predicate	-	
K	can occur with complement with correlative <i>or</i>	-	
L	can occur with measure phrase	-	



M	can occur with <i>right/straight</i> modifier	-	
N	can undergo particle shift	-	
O	can be predicative complement in RAISING constructions	+	... her vested interest <u>is</u> in the educational and aesthetic welfare of her class. [BNC AM6 972]
P	can be non-predicative modifier	-	<i>In recognition of their importance and the need to train more volunteers, we want to develop links with individual churches.</i> [BNC A00 172]

CLASS 29: IN CASE

A	can have NP complement	-	
B	can have what is widely classified as prepositional complement	+	<i>In case of difficulty</i> , further information is available from Wickes Building Supplies Ltd. [BNC: A16 496]
C	can have no complement	+	Best to check your trolley, just <i>in case</i> [___]. [BNC: A0F 801]
D	can have adverbial complement	-	
E	can have <i>that</i> -clause complement	-	
F	can have <i>that</i> -less clause complement	+	Electoral reform cannot be held in reserve <i>in case things go wrong</i> . [BNC: A30 215]
G	can have topicalisation	+	<i>In case that pizza, he might not eat</i> , I prepared another pizza with some mozzarella cheese. [Q]
H	can have small clause complement: overt subject & not <i>-ing</i> predicate	-	
I	can have small clause complement: raised subject & <i>-ing</i> predicate	-	
J	can have small clause complement: raised subj & not <i>-ing</i> predicate	-	
K	can occur with complement with correlative <i>or</i>	-	
L	can occur with measure phrase	-	
M	can occur with <i>right/straight</i> modifier	-	
N	can undergo particle shift	-	
O	can be predicative complement in RAISING constructions	+	It <i>was in case</i> I had a ‘hypo’, she recalls. [BNC: A70 1739]



P	can be non-predicative modifier	+	The text is enclosed here for information, <i>in case local organisations are approached about it.</i> [BNC A10 90]
---	---------------------------------	---	--

CLASS 30: INSTEAD, *regardless*

A	can have NP complement	-	
B	can have what is widely classified as prepositional complement	+	Claire was wearing stockings <i>instead of socks</i> that summer, and her legs looked funny. [BNC: A0D 1636]
C	can have no complement	+	<i>Instead</i> [___], you should simply level out and land ahead. [BNC: A0H 688]
D	can have adverbial complement	-	
E	can have <i>that</i> -clause complement	-	
F	can have <i>that</i> -less clause complement	-	
G	can have topicalisation	-	
H	can have small clause complement: overt subject & not <i>-ing</i> predicate	-	
I	can have small clause complement: raised subject & <i>-ing</i> predicate	-	
J	can have small clause complement: raised subj & not <i>-ing</i> predicate	-	
K	can occur with complement with correlative <i>or</i>	-	
L	can occur with measure phrase	-	
M	can occur with <i>right/straight</i> modifier	-	
N	can undergo particle shift	-	



O	can be predicative complement in RAISING constructions	+	The new privatised inspectors will <i>be instead</i> of public service inspectors. [BNC: HHW 2445]
P	can be non-predicative modifier	+	Then, instead of struggling in vain to prevent them from reaching my consciousness, I stepped back, as it were, and let thoughts and feelings come and go. [BNC: A04 1618]

CLASS 31: INTO, *onto*

A	can have NP complement	+	Why do people get <i>into</i> drugs? [BNC: A01 98]
B	can have what is widely classified as prepositional complement	-	
C	can have no complement	-	
D	can have adverbial complement	-	
E	can have <i>that</i> -clause complement	-	
F	can have <i>that</i> -less clause complement	-	
G	can have topicalisation	-	
H	can have small clause complement: overt subject & not <i>-ing</i> predicate	-	
I	can have small clause complement: raised subject & <i>-ing</i> predicate	+	This is not simply to force people <i>into</i> speaking blank verse, but to see how a person responds to the essential humanity of a character ... [BNC: A06 244]
J	can have small clause complement: raised subj & not <i>-ing</i> predicate	-	
K	can occur with complement with correlative <i>or</i>	-	
L	can occur with measure phrase	+	Five months <i>into</i> the project, we are now at a manageable level and tonight we arrange to open a further six fields over the next week. [BNC: A77 1642]
M	can occur with <i>right/straight</i> modifier	+	Track soon bends right <i>into</i> woods. [BNC: A65 1183]
N	can undergo particle shift	-	



O	can be predicative complement in RAISING constructions	+	But it is <i>into</i> the mouth of one of Darcy's travelling companions that the heart of Keneally's emotional response to the Eritreans is put. [BNC: A36 114]
P	can be non-predicative modifier	+	Klima's girl disappears <i>into</i> the Prague bars, leaving him with an imaginary address. [BNC: A05 695]

CLASS 32: IN ORDER

A	can have NP complement	–	
B	can have what is widely classified as prepositional complement	–	
C	can have no complement	–	
D	can have adverbial complement	–	
E	can have <i>that</i> -clause complement	+	Assumptions and expectations which lie behind an inter-agency approach require to be made more explicit <i>in order</i> that agencies, and individuals within agencies, are absolutely clear about where they stand ... [BNC: ALK 501]
F	can have <i>that</i> -less clause complement	–	
F*	infinitival <i>for</i> complement	+	<i>In order for the abdominals to grow</i> you must treat them like any other muscle group ... [BNC: A0W 520]
G	can have topicalisation	+	He did everything <i>in order that this pizza he would get</i> . [Q]
H	can have small clause complement: overt subject & not <i>-ing</i> predicate	–	
I	can have small clause complement: raised subject & <i>-ing</i> predicate	–	
J	can have small clause complement: raised subj & not <i>-ing</i> predicate	–	
K	can occur with complement with correlative <i>or</i>	–	



L	can occur with measure phrase	–	
M	can occur with <i>right/straight</i> modifier	–	
N	can undergo particle shift	–	
O	can be predicative complement in RAISING constructions	+	This <u>was in order</u> to convince him ... [BNC: ALK 324]
P	can be non-predicative modifier	+	<u>In order to get rid of the whole web of interlinked concepts, myths, wishes and desires</u> , one has to mine it from within. [BNC: A08 1451]

CLASS 33: IN TWO MINDS

A	can have NP complement	-	
B	can have what is widely classified as prepositional complement	+	The poem, we might say, is <i>in two minds</i> <u>about</u> itself and its own meaning. [BNC A1B 1732]
C	can have no complement	+	It is characteristic of faith that it cannot remain [__]; it cannot leave things in the air. [BNC C8V 1643]
D	can have adverbial complement	-	
E	can have <i>that</i> -clause complement	-	
F	can have <i>that</i> -less clause complement	-	
G	can have topicalisation	-	
H	can have small clause complement: overt subject & not <i>-ing</i> predicate	-	
I	can have small clause complement: raised subject & <i>-ing</i> predicate	-	
J	can have small clause complement: raised subj & not <i>-ing</i> predicate	-	

K	can occur with complement with correlative <i>or</i>	–	
L	can occur with measure phrase	–	
M	can occur with <i>right/straight</i> modifier	–	
N	can undergo particle shift	–	
O	can be predicative complement in RAISING constructions	+	Ramsay <u>was</u> in two minds as to whether it was wise to allow himself to be bottled up in the town when his place arguably was with the Regent; but he decided that he might possibly play a more useful part here as Seton's assistant — and he ought to be able to escape by boat, at night, if necessary. [BNC A05 690]
P	can be non-predicative modifier	–	

CLASS 34: LEST, *whereupon*, *since* (non-temporal), *whereas*, *that* (purposive), *as* (causative), *as soon as*, *as long as*

A	can have NP complement	–	
B	can have what is widely classified as prepositional complement	–	
C	can have no complement	–	
D	can have adverbial complement	–	
E	can have <i>that</i> -clause complement	–	



F	can have <i>that</i> -less clause complement	+	I was self-conscious about my body to a painful degree, and terrified <i>lest <u>the weight came back.</u></i> [BNC: ADG 1577]
G	can have topicalisation	+	He wears headphones now <i>lest <u>John, he might disturb.</u></i> [Q]
H	can have small clause complement: overt subject & not <i>-ing</i> predicate	-	
I	can have small clause complement: raised subject & <i>-ing</i> predicate	-	
J	can have small clause complement: raised subj & not <i>-ing</i> predicate	-	
K	can occur with complement with correlative <i>or</i>	-	
L	can occur with measure phrase	-	
M	can occur with <i>right/straight</i> modifier	-	
N	can undergo particle shift	-	
O	can be predicative complement in RAISING constructions	-	
P	can be non-predicative modifier	+	I worried all night, <i>lest the listing in the local paper and in the Order of St John country handbook had not been enough.</i> [BNC: A0G 199]

CLASS 35: NEAR, *alongside*

A	can have NP complement	+	It was <i>near</i> <u>midnight</u> . [BNC: A0L 574]
B	can have what is widely classified as prepositional complement	+	The latrine situated <i>near</i> <u>to the road at the far end of the orchard</u> has been moved to the other side ... [BNC: A61 1367]
C	can have no complement	+	Read Mr Adzhubey and you sense a Khrushchev who, at 70, knew that his end was <i>near</i> [___]. [BNC: A5M 192]
D	can have adverbial complement	-	
E	can have <i>that</i> -clause complement	-	
F	can have <i>that</i> -less clause complement	-	
G	can have topicalisation	-	
H	can have small clause complement: overt subject & not <i>-ing</i> predicate	-	
I	can have small clause complement: raised subject & <i>-ing</i> predicate	-	
J	can have small clause complement: raised subj & not <i>-ing</i> predicate	-	
K	can occur with complement with correlative <i>or</i>	-	
L	can occur with measure phrase	-	
M	can occur with <i>right/straight</i> modifier	+	That's <u>right</u> <i>near</i> the window ... [BNC: HMA 425]
N	can undergo particle shift	-	

O	can be predicative complement in RAISING constructions	+	It <i>was near</i> midnight. [BNC: AOL 574]
P	can be non-predicative modifier	+	<i>Near the Gethsemane church in the run-down Prenzlauer Berg district</i> , police attacked a candlelit procession by about 1,000 young people ... [BNC: A41 5]

If morphological properties were included in this study, *near* will definitely belong to a different class. This is due to the fact that it can occur in a comparative form as an ordinary adjective does (Pullum & Huddleston2002). See the example in (5) to clarify the point.

6. Innocuous would be *nearer* the mark. [BNC: A1N 432]



CLASS 36: NEXT, *close, far, abreast*

A	can have NP complement	-	
B	can have what is widely classified as prepositional complement	+	First of all, outside the city, <i>next to a growth of forest</i> , there is Thrushcross Grange. [BNC: A05 26]
C	can have no complement	+	When Roger Collins was sentenced to death aged 18 he had no idea what would happen <i>next</i> [___]. [BNC: A03 730]
D	can have adverbial complement	-	
E	can have <i>that</i> -clause complement	-	
F	can have <i>that</i> -less clause complement	-	
G	can have topicalisation	-	
H	can have small clause complement: overt subject & not <i>-ing</i> predicate	-	
I	can have small clause complement: raised subject & <i>-ing</i> predicate	-	
J	can have small clause complement: raised subj & not <i>-ing</i> predicate	-	
K	can occur with complement with correlative <i>or</i>	-	
L	can occur with measure phrase	-	
M	can occur with <i>right/straight</i> modifier	+	He was <i>right next</i> to the linesman when he called him a name and he deserved to go. [BNC: CH7 4298]
N	can undergo particle shift	-	

O	can be predicative complement in RAISING constructions	+	It <u>is</u> <i>next</i> to the showers. [BNC: A59 141]
P	can be non-predicative modifier	+	<i>Next to it</i> , there's a street, Regent Street, with balconies. [BNC: B24 2399]

The justification of the inclusion of *close* and *far* in the category Preposition by Pullum and Huddleston (2002) although they are gradable (i.e. *very close* and *very far*) and have comparative forms (i.e. *closer* and *further*) as ordinary adjectives is that they satisfy the non-predicative adjunct criterion they set for identifying prepositions.

CLASS 37: NOTWITHSTANDING

A	can have NP complement	+	(i) <i>Notwithstanding <u>this promise</u></i> , the use of road pricing to change travel habits still seems some way off. [BNC: A2L 73] (ii) <i>That <u>caveat notwithstanding</u></i> , those close to Mr Bush insist that there was ... [BNC: ABH 658]
B	can have what is widely classified as prepositional complement	–	
C	can have no complement	+	Lewes managed to thrive <i>notwithstanding</i> [___]. [BNC: CB6 614]
D	can have adverbial complement	–	
E	can have <i>that</i> -clause complement	+	This was <i>notwithstanding <u>that he had not found the relationship between the bank and the husband to be one of principal and agent</u></i> . [BNC: FD3 645]
F	can have <i>that</i> -less clause complement	+	For its parts, a Bill of Rights insists that certain rights, privileges, and liberties are basic and must be afforded to all individuals <i>notwithstanding <u>what transient governments might wish to do</u></i> . [BNC: G3L 1071]
G	can have topicalisation	+	<i>Notwithstanding <u>that the solution he understands</u></i> , he cannot solve the problem. [Q]
H	can have small clause complement: overt subject & not <i>-ing</i> predicate	–	
I	can have small clause complement: raised subject & <i>-ing</i> predicate	–	
J	can have small clause complement: raised subj & not <i>-ing</i> predicate	–	



K	can occur with complement with correlative <i>or</i>	–	
L	can occur with measure phrase	–	
M	can occur with <i>right/straight</i> modifier	–	
N	can undergo particle shift	–	
O	can be predicative complement in RAISING constructions	+	This <i>was notwithstanding</i> a finding that the wife ‘did sufficiently understand the general nature of the document.’ [BNC: FD3 426]
P	can be non-predicative modifier	+	<i>Notwithstanding</i> current problems which they discussed lightly, it had all been wonderful. [BNC: AC2 1394]

CLASS 38: NOW

A	can have NP complement	-	
B	can have what is widely classified as prepositional complement	-	
C	can have no complement	+	I would like to be an ACET volunteer so what do I do <i>now</i> ? [BNC: A00 109]
D	can have adverbial complement	-	
E	can have <i>that</i> -clause complement	+	... <i>now</i> that I am at last working on the big glass and have set up the two panels and locked them into their metal frame, notions like success and failure are no longer pertinent ... [BNC A08 111]
F	can have <i>that</i> -less clause complement	-	
G	can have topicalisation	+	Now <u><i>that the solution, he understands</i></u> , he can solve the problem. [Q]
H	can have small clause complement: overt subject & not <i>-ing</i> predicate	-	
I	can have small clause complement: raised subject & <i>-ing</i> predicate	-	
J	can have small clause complement: raised subj & not <i>-ing</i> predicate	-	
K	can occur with complement with correlative <i>or</i>	-	
L	can occur with measure phrase	-	



M	can occur with <i>right/straight</i> modifier	+	I want an answer, <i>right now</i> ! [BNC A0F 93]
N	can undergo particle shift	-	
O	can be predicative complement in RAISING constructions	+	However, when no real progress is made, the time comes for reassessment, and it seems to me that that time is <i>now</i> . [BNC HHX 11310]
P	can be non-predicative modifier	+	<i>Now</i> , what we've got here is a lump of wood roughly the same shape trying to be a cricket bat ... [BNC A06 1023]

CLASS 39: OF

A	can have NP complement	+	Shopping including collection of <i>prescriptions</i> . [BNC: A00 86]
B	can have what is widely classified as prepositional complement	-	
C	can have no complement	-	
D	can have adverbial complement	-	
E	can have <i>that</i> -clause complement	-	
F	can have <i>that</i> -less clause complement	-	
G	can have topicalisation	-	
H	can have small clause complement: overt subject & not <i>-ing</i> predicate	+	Really, it's a case of <i>head versus heart</i> . [BNC: A15 1262]
I	can have small clause complement: raised subject & <i>-ing</i> predicate	+	Most churches are completely unprepared for the shock of <i>finding an established member of the congregation</i> is infected with HIV or dying with AIDS, even though this is increasingly common. [BNC: A00 131]
J	can have small clause complement: raised subj & not <i>-ing</i> predicate	-	
K	can occur with complement with correlative <i>or</i>	-	
L	can occur with measure phrase	-	



M	can occur with <i>right/straight</i> modifier	-	
N	can undergo particle shift	-	
O	can be predicative complement in RAISING constructions	+	The sky <u>is</u> of the blue of an English summer day, with large, but not threatening, clouds of a silvery whiteness. [BNC: A04 801]
P	can be non-predicative modifier	-	

CLASS 40: ON (non-loc), *off* (non-loc)

A	can have NP complement	-	
B	can have what is widely classified as prepositional complement	-	
C	can have no complement	+	As before, the news was <i>on</i> [___]. [BNC: A0R 1701]
D	can have adverbial complement	-	
E	can have <i>that</i> -clause complement	-	
F	can have <i>that</i> -less clause complement	-	
G	can have topicalisation	-	
H	can have small clause complement: overt subject & not <i>-ing</i> predicate	-	
I	can have small clause complement: raised subject & <i>-ing</i> predicate	-	
J	can have small clause complement: raised subj & not <i>-ing</i> predicate	-	
K	can occur with complement with correlative <i>or</i>	-	
L	can occur with measure phrase	+	<i>Twelve months on</i> , Sir Angus is not really worried on either score. [BNC: A1J 163]
M	can occur with <i>right/straight</i> modifier	-	
N	can undergo particle shift	+	(i) Suddenly we realised it was eight o'clock and we rushed to the sitting room to put on <i>the TV</i> . [BNC: A57 290]



			(ii) Put <i>the kettle</i> on, spooned coffee, rolled a cigarette, sat up in bed again and hoped the horrors had forgotten her address. [BNC: AOL 3372]
O	can be predicative complement in RAISING constructions	+	As before, the news <i>was on</i> . [BNC: AOR 1701]
P	can be non-predicative modifier	+	<i>Twelve months on</i> , Sir Angus is not really worried on either score. [BNC: A1J 163]

CLASS 41: OVER, *down*, *across*, *along*, *through*, *round*, *around*, *under*, *inside*, *off* (loc), *in* (loc), *outside* (loc), *on* (loc)

A	can have NP complement	+	He subsequently received a discount of just <i>over</i> £50 after complaining about the telephone charge. [BNC A0C 221]
B	can have what is widely classified as prepositional complement	-	
C	can have no complement	+	... the trailer rolls <i>over</i> [___]. [BNC A0H 320]
D	can have adverbial complement	-	
E	can have <i>that</i> -clause complement	-	
F	can have <i>that</i> -less clause complement	-	
G	can have topicalisation	-	
H	can have small clause complement: overt subject & not <i>-ing</i> predicate	-	
I	can have small clause complement: raised subject & <i>-ing</i> predicate	-	
J	can have small clause complement: raised subj & not <i>-ing</i> predicate	-	
K	can occur with complement with correlative <i>or</i>	-	



L	can occur with measure phrase	+	PLANS to turn the site of a former explosives factory at Annan, Dumfriesshire, into Scotland's top rallying centre were put forward yesterday by the 300-strong Wigton Motor Club which is based <i>a few miles over</i> the border in Cumbria. [K5D 353]
M	can occur with <i>right/straight</i> modifier	+	They went <i>right over</i> the top. [BNC AJM 52]
N	can undergo particle shift	+	(i) he wrote, tearing the sheet in his hurry to turn <i>over the page</i> ... [BNC A08 1423] (ii) We now wait in suspense for the banker to turn <i>the cards over</i> . [BNC ARR 305]
O	can be predicative complement in RAISING constructions	+	As this <i>is over</i> the inheritance tax threshold, it would bring a tax bill of £4,800. [BNC A01 437]
P	can be non-predicative modifier	+	Tony has been unwell <i>over the weekend</i> . [BNC A00 376]

CLASS 42: PER

A	can have NP complement	+	This works out at the equivalent of just £10 <i>per day</i> . [BNC: A01 211]
B	can have what is widely classified as prepositional complement	-	
C	can have no complement	+	Seven hundred rounds <i>per</i> , at two and three-quarter thousand f.p.s. [BNC: HR7 2993]
D	can have adverbial complement	-	
E	can have <i>that</i> -clause complement	-	
F	can have <i>that</i> -less clause complement	-	
G	can have topicalisation	-	
H	can have small clause complement: overt subject & not <i>-ing</i> predicate	-	



I	can have small clause complement: raised subject & <i>-ing</i> predicate	-	
J	can have small clause complement: raised subj & not <i>-ing</i> predicate	-	
K	can occur with complement with correlative <i>or</i>	-	
L	can occur with measure phrase	-	
M	can occur with <i>right/straight</i> modifier	-	
N	can undergo particle shift	-	
O	can be predicative complement in RAISING constructions	+	Prices are <i>per</i> person in cabin one way. [BNC: EBN 210]
P	can be non-predicative modifier	-	

CLASS 43: PROVIDED, *providing, supposing, seeing, allowing, on (the) condition*

A	can have NP complement	-	
B	can have what is widely classified as prepositional complement	-	
C	can have no complement	-	
D	can have adverbial complement	-	
E	can have <i>that</i> -clause complement	+	<i>Provided <u>that the pilot keeps to the correct procedures</u>, winch and car launches can be very safe. [BNC: A0H 568]</i>
F	can have <i>that</i> -less clause complement	+	<i>Provided <u>the gift is at least £600</u> it will be regarded as having been paid net of basic rate tax. [BNC: A01 322]</i>
G	can have topicalisation	+	<i>Provided <u>that on time the boat leaves</u>, we reach France by morning. [Q]</i>
H	can have small clause complement: overt subject & not <i>-ing</i> predicate	-	
I	can have small clause complement: raised subject & <i>-ing</i> predicate	-	
J	can have small clause complement: raised subj & not <i>-ing</i> predicate	-	
K	can occur with complement with correlative <i>or</i>	-	
L	can occur with measure phrase	-	
M	can occur with <i>right/straight</i> modifier	-	
N	can undergo particle shift	-	



O	can be predicative complement in RAISING constructions	+	This <i>is provided</i> that the product returned is received back to us within the 14 day returns period or is faulty. [Google Web]
P	can be non-predicative modifier	+	But it is possible to have a covenant which lasts for a longer period, <i>provided that the period is specified in the Deed</i> . [BNC: A01 249]

CLASS 44: SINCE (temporal)

A	can have NP complement	+	About one-third of pupils have traditionally attended them <i>since that time</i> . [BNC A07 1347]
B	can have what is widely classified as prepositional complement	-	
C	can have no complement	+	This was in September 1989 and he has been in prison <i>since [__]</i> . [BNC A03 653]
D	can have adverbial complement	-	
E	can have <i>that</i> -clause complement	-	
F	can have <i>that</i> -less clause complement	+	<i>Since <u>black people in the southern states have suffered more injustices at the hands of the law</u> they tend to be less likely to hand out death sentences.</i> [BNC A03 718]
G	can have topicalisation	-	
H	can have small clause complement: overt subject & not <i>-ing</i> predicate	-	
I	can have small clause complement: raised subject & <i>-ing</i> predicate	+	<i>Since <u>being in Norway</u>, he has been used to stud not only by the Norwegians but also by the top Swedish kennel Faunus, which is owned and run by Gun Berquist.</i> [BNC AR5 444]
J	can have small clause complement: raised subj & not <i>-ing</i> predicate	-	
K	can occur with complement with correlative <i>or</i>	-	
L	can occur with measure phrase	-	



M	can occur with <i>right/straight</i> modifier	-	
N	can undergo particle shift	-	
O	can be predicative complement in RAISING constructions	+	... it <u>was</u> <i>since</i> we had had a bath. [BNC A61 1691]
P	can be non-predicative modifier	+	This can cause problems, <i>since you agree under the terms of the covenant to make payments out of income from which tax has been deducted.</i> [BNC A01 283]

CLASS 45: THAT (empty)

A	can have NP complement	-	
B	can have what is widely classified as prepositional complement	-	
C	can have no complement	-	
D	can have adverbial complement	-	
E	can have <i>that</i> -clause complement	-	
F	can have <i>that</i> -less clause complement	+	ACET volunteers work as part of a team and provide help in many different ways to ensure <i>that people don't spend time in hospital unnecessarily</i> . [BNC: A00 82]
G	can have topicalisation	+	Notwithstanding <i>that the solution he understands</i> , he cannot solve the problem. [Q]
H	can have small clause complement: overt subject & not <i>-ing</i> predicate	-	
I	can have small clause complement: raised subject & <i>-ing</i> predicate	-	
J	can have small clause complement: raised subj & not <i>-ing</i> predicate	-	
K	can occur with complement with correlative <i>or</i>	-	
L	can occur with measure phrase	-	
M	can occur with <i>right/straight</i> modifier	-	
N	can undergo particle shift	-	



O	can be predicative complement in RAISING constructions	+	A difficulty <i>is that</i> psychology has narrow terms of reference which can give only a few useful results. [BNC: A04 1509]
P	can be non-predicative modifier	-	

CLASS 46: TIMES

A	can have NP complement	-	
B	can have what is widely classified as prepositional complement	-	
C	can have no complement	+	... even if you only do it <i>once</i> [___]. [BNC: A01 132]
D	can have adverbial complement	-	
E	can have <i>that</i> -clause complement	-	
F	can have <i>that</i> -less clause complement	-	
G	can have topicalisation	-	
H	can have small clause complement: overt subject & not <i>-ing</i> predicate	-	
I	can have small clause complement: raised subject & <i>-ing</i> predicate	-	
J	can have small clause complement: raised subj & not <i>-ing</i> predicate	-	
K	can occur with complement with correlative <i>or</i>	-	
L	can occur with measure phrase	-	
M	can occur with <i>right/straight</i> modifier	-	
N	can undergo particle shift	-	



O	can be predicative complement in RAISING constructions	+	No it was what they called the manual that's for learning woodwork, that <u>was</u> <i>once</i> a week. [BNC HEC 31]
P	can be non-predicative modifier	+	... They can kill, and injecting drugs with a shared needle or syringe can be the fastest way to get HIV — even if you only do it <i>once</i> . [BNC: A01 132]

CLASS 47: TOUCHING, *following*

A	can have NP complement	+	'The epileptic' makes a neat reply, again <i>touching life and art</i> simultaneously: the author and hero of The Idiot. [BNC: A18 794]
B	can have what is widely classified as prepositional complement	+	Other essays continue this theme, <i>touching on topics from green jobs</i> . [COCA: 2012]
C	can have no complement	-	
D	can have adverbial complement	-	
E	can have <i>that</i> -clause complement	-	
F	can have <i>that</i> -less clause complement	-	
G	can have topicalisation	-	
H	can have small clause complement: overt subject & not <i>-ing</i> predicate	-	
I	can have small clause complement: raised subject & <i>-ing</i> predicate	-	
J	can have small clause complement: raised subj & not <i>-ing</i> predicate	-	
K	can occur with complement with correlative <i>or</i>	-	
L	can occur with measure phrase	-	
M	can occur with <i>right/straight</i> modifier	-	
N	can undergo particle shift	-	



O	can be predicative complement in RAISING constructions	+	I recently did a workshop at the International Theraplay® conference where the topic <i>was</i> <i>touching</i> sexually abused children. [Google Web]
P	can be non-predicative modifier	+	Other essays continue this theme, <i>touching on topics</i> <i>from green jobs</i> [COCA: 2012]

CLASS 48: UNLESS, *if* (conditional)

A	can have NP complement	-	
B	can have what is widely classified as prepositional complement	-	
C	can have no complement	-	
D	can have adverbial complement	-	
E	can have <i>that</i> -clause complement	-	
F	can have <i>that</i> -less clause complement	+	But, <i>unless you are considering a particularly large donation</i> , it is unlikely that you would need to include any complicated form of wording. [BNC: A01 309]
G	can have topicalisation	+	<i>Unless a lesson like this, the tutor includes</i> , I won't do the exam. (in the context where the speaker won't do the exam if lessons of other formats are included.) [Q]
H	can have small clause complement: overt subject & not <i>-ing</i> predicate	-	
I	can have small clause complement: raised subject & <i>-ing</i> predicate	+	... I experience severe fuel starvation causing the engine to stop <i>unless travelling fast on an open road</i> . [BNC: AN2 93]
J	can have small clause complement: raised subj & not <i>-ing</i> predicate	+	... make sure it isn't made from tropical hardwoods, <i>unless from a sustainable source</i> . [BNC: A7G 696]
K	can occur with complement with correlative <i>or</i>	-	
L	can occur with measure phrase	-	
M	can occur with <i>right/straight</i> modifier	-	



N	can undergo particle shift	-	
O	can be predicative complement in RAISING constructions	+	That <u>is</u> <i>unless</i> it's sold to the sort of person who blasts half of his land away to quarry gravel for motorways ... [BNC: AS3 412]
P	can be non-predicative modifier	+	... <i>unless you are considering a particularly large donation</i> , it is unlikely that you would need to include any complicated form of wording. [BNC: A01 309]

CLASS 49: UNTIL

A	can have NP complement	+	He was arrested shortly after his arrival and was detained without trial <i>until September</i> when he was sentenced to ten years' hard labour for alleged espionage. [BNC: A03 667]
B	can have what is widely classified as prepositional complement	-	
C	can have no complement	-	
D	can have adverbial complement	+	<i>Until recently</i> , male chefs have shut their kitchen doors on girls wanting to learn the profession. [BNC: A0C 1574]
E	can have <i>that</i> -clause complement	-	
F	can have <i>that</i> -less clause complement	+	Her daughters have however been contacted so I agree to keep her company <i>until they arrive</i> . [BNC A00 406]
G	can have topicalisation	+	<i>Until this solution, he understands</i> , he can solve the problem. [Q]
H	can have small clause complement: overt subject & not <i>-ing</i> predicate	-	
I	can have small clause complement: raised subject & <i>-ing</i> predicate	+	In 1961 he travelled to Brazil where he lived first under the name Peter Hochbichler <i>until taking the name Gerhard in 1976</i> . [BNC: AJE 16]
J	can have small clause complement: raised subj & not <i>-ing</i> predicate	+	start negotiations but do not book <i>until in Nepal</i> so you can meet the agents and potential guides before committing. [Google Web]
K	can occur with complement with correlative <i>or</i>	-	
L	can occur with measure phrase	-	



M	can occur with <i>right/straight</i> modifier	+	He came into the office <i>right until</i> the last days of his illness. [BNC: CBU 473]
N	can undergo particle shift	-	
O	can be predicative complement in RAISING constructions	+	That <i>is until</i> the BBC came along. [BNC: A6W 304]
P	can be non-predicative modifier	+	In compliance with the licensing laws the children's rehearsal wasn't to be held <i>until later in the afternoon</i> . [BNC: FNU 948]

CLASS 50: UP, out

A	can have NP complement	+	Jack and Jill went <i>up the hill</i> to fetch a pail of water ... [BNC: A0D 279]
B	can have what is widely classified as prepositional complement	+	Dr Dixon said, 'With <i>up to 20 years from infection to illness</i> , we just have to ask how many of our congregation have been added during that time? [BNC: A00 134]
C	can have no complement	+	Do not look <i>up</i> [___]. [BNC: A08 1589]
D	can have adverbial complement	-	
E	can have <i>that</i> -clause complement	-	
F	can have <i>that</i> -less clause complement	-	
G	can have topicalisation	-	
H	can have small clause complement: overt subject & not <i>-ing</i> predicate	-	
I	can have small clause complement: raised subject & <i>-ing</i> predicate	-	
J	can have small clause complement: raised subj & not <i>-ing</i> predicate	-	
K	can occur with complement with correlative <i>or</i>	-	
L	can occur with measure phrase	+	Don't bother, I said, it's <i>six floors up</i> . [BNC: A6E 552]
M	can occur with <i>right/straight</i> modifier	+	But it also went <i>right up</i> to the fifties. [BNC: A6E 232]



N	can undergo particle shift	+	(i) It is tempting to hang on to the launch, thinking that it will pick <i>up speed</i> ... [BNC: A0H 733] (ii) 'I pick <i>things up</i> ,' she said. [BNC: CJA 1128]
O	can be predicative complement in RAISING constructions	+	But not before the sun <i>is up</i> . [BNC: A0N 491]
P	can be non-predicative modifier	+	Fay and Sara rode <i>up a steep track</i> . [BNC: A0R 2246]

CLASS 51: UPON, *via*, *on* ('concerning'), *about* ('concerning'), *by* (non-loc)

A	can have NP complement	+	The impact <i>upon the personality expectations</i> and the way of life of a mature scholar by the University experience is not appreciated by many of the police ... [BNC: A0K 376]
B	can have what is widely classified as prepositional complement	-	
C	can have no complement	-	
D	can have adverbial complement	-	
E	can have <i>that</i> -clause complement	-	
F	can have <i>that</i> -less clause complement	-	
G	can have topicalisation	-	
H	can have small clause complement: overt subject & not <i>-ing</i> predicate	-	
I	can have small clause complement: raised subject & <i>-ing</i> predicate	+	Upon <i>regaining consciousness</i> , he'd panicked when his limbs, leaden and numb, had refused to obey him. [BNC: AD9 2080]
J	can have small clause complement: raised subj & not <i>-ing</i> predicate	-	
K	can occur with complement with correlative <i>or</i>	-	
L	can occur with measure phrase	-	



M	can occur with <i>right/straight</i> modifier	-	
N	can undergo particle shift	-	
O	can be predicative complement in RAISING constructions	+	A playful puppyish mood <i>is upon</i> you ... [BNC: ACM 698]
P	can be non-predicative modifier	+	<i>Upon his release from prison</i> , his shorn flock welcomed him back with open arms. [COCA: 2012]

CLASS 52: VERSUS, *minus*, *worth*, *gone* (BrE), *less* (“minus”)

A	can have NP complement	+	Really, it's a case of head <i>versus</i> <u>heart</u> . [BNC: A15 1262]
B	can have what is widely classified as prepositional complement	-	
C	can have no complement	-	
D	can have adverbial complement	-	
E	can have <i>that</i> -clause complement	-	
F	can have <i>that</i> -less clause complement	-	
G	can have topicalisation	-	
H	can have small clause complement: overt subject & not <i>-ing</i> predicate	-	
I	can have small clause complement: raised subject & <i>-ing</i> predicate	-	
J	can have small clause complement: raised subj & not <i>-ing</i> predicate	- -	
K	can occur with complement with correlative <i>or</i>	-	
L	can occur with measure phrase	-	
M	can occur with <i>right/straight</i> modifier	-	
N	can undergo particle shift	-	



O	can be predicative complement in RAISING constructions	+	Typical half-wave reduction potentials for 1,2 compounds <i>are versus</i> the standard calomel electrode (SCE) while those for the 1,3-isomers are 0.2V. [BNC: ALW 2304]
P	can be non-predicative modifier	-	

CLASS 53: WHEN, *where*

A	can have NP complement	-	
B	can have what is widely classified as prepositional complement	-	
C	can have no complement	-	
D	can have adverbial complement	-	
E	can have <i>that</i> -clause complement	-	
F	can have <i>that</i> -less clause complement	+	<i>When <u>people are fleeing from fear of imprisonment, torture or death</u>, they will use any means available to reach a safe country. [BNC: A03 947]</i>
G	can have topicalisation	+	<i>When <u>this solution, he understands</u>, he will be able to solve the problem. [Q]</i>
H	can have small clause complement: overt subject & not <i>-ing</i> predicate	-	
I	can have small clause complement: raised subject & <i>-ing</i> predicate	+	<i>When auditioning for most schools you will be asked to present at least two contrasting speeches and possibly give some idea of your attitude to improvisation and, perhaps, to singing. [BNC A06 220]</i>
J	can have small clause complement: raised subj & not <i>-ing</i> predicate	+	<i>When <u>in trouble</u> he could, like a god, make himself invisible ... [BNC: A12 1116]</i>
K	can occur with complement with correlative <i>or</i>	-	
L	can occur with measure phrase	-	



M	can occur with <i>right/straight</i> modifier	+	He also thinks that if the time is <i>right when</i> unmarried women were [unclear] property and he thought it wouldn't be long before married women to hold property too ... [BNC HUF 214]
N	can undergo particle shift	-	
O	can be predicative complement in RAISING constructions	+	This <i>was when</i> Chris Spedding, the guitarist, started hanging out in the shop. [BNC A6E 668]
P	can be non-predicative modifier	+	<i>When someone is ill with AIDS</i> they are often in pain. [BNC: A01 185]

CLASS 54: WHENEVER, *wherever*

A	can have NP complement	-	
B	can have what is widely classified as prepositional complement	-	
C	can have no complement	+	we don't increase the allocation, when he gets to sixty, or sixty five or <i>whenever</i> [___]. [BNC JK7 428]
D	can have adverbial complement	-	
E	can have <i>that</i> -clause complement	-	
F	can have <i>that</i> -less clause complement	+	The routine sheets should be filled in each week or <i>whenever <u>the weight is increased</u></i> . [BNC A0W 481]
G	can have topicalisation	+	<i>Whenever <u>that song</u></i> , John sings, everyone leaves the hall. (whereas in other cases where he sings other songs, everyone keeps listening). [Q]
H	can have small clause complement: overt subject & not <i>-ing</i> predicate	-	



I	can have small clause complement: raised subject & <i>-ing</i> predicate	+	albeit of the kind one hopes to run into <i>whenever entering</i> a New York bar. [BNC CLS 741]
J	can have small clause complement: raised subj & not <i>-ing</i> predicate	+	
K	can occur with complement with correlative <i>or</i>	-	
L	can occur with measure phrase	-	
M	can occur with <i>right/straight</i> modifier	-	
N	can undergo particle shift	-	
O	can be predicative complement in RAISING constructions	+	... that <i>is</i> <i>whenever</i> CB and PB appear. [BNC CGS 1832]
P	can be non-predicative modifier	+	I have to take off my shoes <i>whenever I can</i> . [BNC A08 1700]

CLASS 55: WHETHER

A	can have NP complement	-	
B	can have what is widely classified as prepositional complement	-	
C	can have no complement	-	
D	can have adverbial complement	-	
E	can have <i>that</i> -clause complement	-	
F	can have <i>that</i> -less clause complement	+	But <i>whether the statement is rhetoric or reality</i> , ... we will have to wait and see. [BNC: A07 1062]
G	can have topicalisation	+	<i>Whether the truth he tells</i> , more investigation is still needed. [Q]
H	can have small clause complement: overt subject & not <i>-ing</i> predicate	-	
I	can have small clause complement: raised subject & <i>-ing</i> predicate	+	I have learnt the secret of being content ... in any and every situation, whether well fed or hungry, <i>whether living in plenty or in want</i> .' [BNC: ARG 2098]
J	can have small clause complement: raised subj & not <i>-ing</i> predicate	+	... the works may be described from room to room, <i>whether in a book or on a sound guide</i> . [BNC: A04 526]
K	can occur with complement with correlative <i>or</i>	+	<i>Whether</i> the final total is £5 <i>or</i> £5,000, it is all very much needed. [BNC: A00 41]
L	can occur with measure phrase	-	
M	can occur with <i>right/straight</i> modifier	-	
N	can undergo particle shift	-	



O	can be predicative complement in RAISING constructions	+	But the main area of controversy <i>is whether</i> simply obtaining unauthorised access to a computer should be a crime. [BNC: A3G 511]
P	can be non-predicative modifier	+	<i>Whether the final total is £5 or £5,000</i> , it is all very much needed. [BNC: A00 41]

CLASS 56: WHILE (temporal), *as* (temporal), *whilst* (temporal), *once* (temporal)

A	can have NP complement	-	
B	can have what is widely classified as prepositional complement	-	
C	can have no complement	-	
D	can have adverbial complement	-	
E	can have <i>that</i> -clause complement	-	
F	can have <i>that</i> -less clause complement	+	<i>While <u>over 2,300 people wait on death rows countrywide to see if they will die or not</u>, we can only hope that the US comes to its senses soon. [BNCA03 749]</i>
G	can have topicalisation	-	
H	can have small clause complement: overt subject & not <i>-ing</i> predicate	-	
I	can have small clause complement: raised subject & <i>-ing</i> predicate	+	More than sixty years after the event, <i><u>while watching a child of his own try out his first steps</u></i> , he suddenly stated in reminiscence and satisfaction to his most intimate Spanish friend [BNC A04 127]
J	can have small clause complement: raised subj & not <i>-ing</i> predicate	+	<i>While <u>in Stratford</u></i> she also played Jessica in The Merchant of Venice and Moth in Love's Labours Lost. [BNC: A06 1676]
K	can occur with complement with correlative <i>or</i>	-	
L	can occur with measure phrase	-	



M	can occur with <i>right/straight</i> modifier	-	
N	can undergo particle shift	-	
O	can be predicative complement in RAISING constructions	+	It <u>was</u> <i>while</i> we were sitting there that my father must have died of a heart attack in Bath. [BNC: AC6 1572]
P	can be non-predicative modifier	+	<i>While over 2,300 people wait on death rows countrywide to see if they will die or not</i> , we can only hope that the US comes to its senses soon. [BNC A03 749]

CLASS 57: WITH

A	can have NP complement	+	Many people <i>with AIDS</i> have to spend long periods of time in hospital unless there is someone at home who can help and look after them. [BNC: A00 81]
B	can have what is widely classified as prepositional complement	-	
C	can have no complement	-	
D	can have adverbial complement	-	
E	can have <i>that</i> -clause complement	-	
F	can have <i>that</i> -less clause complement	-	
G	can have topicalisation	-	
H	can have small clause complement: overt subject & not <i>-ing</i> predicate	+	He drops the script and hops about <i>with hands in his armpits</i> , going 'Ouch!' [BNC: A06 1033]
I	can have small clause complement: raised subject & <i>-ing</i> predicate	+	They were charged <i>with having formed a 'hostile' organization aimed at securing republic status for Kosovo province</i> . [BNC: A03 615]
J	can have small clause complement: raised subj & not <i>-ing</i> predicate	-	
K	can occur with complement with correlative <i>or</i>	-	
L	can occur with measure phrase	-	
M	can occur with <i>right/straight</i> modifier	-	
N	can undergo particle shift	-	



O	can be predicative complement in RAISING constructions	+	It <i>is</i> <i>with</i> great regret that I see so many students labouring day after day in the Academy ... [BNC: A04 349]
P	can be non-predicative modifier	+	In this way, <i>with a little money but much commitment</i> , a great deal can be done. [BNC: A00 185]

CLASS 58: WITHOUT

A	can have NP complement	+	<i>Without <u>that certificate</u></i> , the charity cannot obtain the repayment of the basic rate tax and the donor cannot get higher rate relief. [BNC: A01 330]
B	can have what is widely classified as prepositional complement	-	
C	can have no complement	-	
D	can have adverbial complement	-	
E	can have <i>that</i> -clause complement	-	
F	can have <i>that</i> -less clause complement	+	She will not get marries <i>without <u>her father provides his blessing</u></i> . [Q]
G	can have topicalisation	+	She will not get marries <i>without <u>lots of blessings, her father provides</u></i> . [Q]
H	can have small clause complement: overt subject & not <i>-ing</i> predicate	+	What's going to happen to you without <i><u>me behind you</u></i> ? [BNC: CFY 907]
I	can have small clause complement: raised subject & <i>-ing</i> predicate	+	You can be infected for between 10–15 years <i>without <u>realising it</u></i> . [BNC: A00 16]
J	can have small clause complement: raised subj & not <i>-ing</i> predicate	-	
K	can occur with complement with correlative <i>or</i>	-	
L	can occur with measure phrase	-	
M	can occur with <i>right/straight</i> modifier	-	



N	can undergo particle shift	-	
O	can be predicative complement in RAISING constructions	+	I <i>was</i> without the religious sense of my family. [BNC: A05 183]
P	can be non-predicative modifier	+	Once you're infected the virus may destroy your natural defences for over 10 years <i>without you realising</i> . [BNC: A01 5]

CLASS 59: X-STAIRS, x-hill, x-stage, x-stream, x-ward(s), under-x, x-doors, over-x, aloft

A	can have NP complement	-	
B	can have what is widely classified as prepositional complement	-	
C	can have no complement	+	I want the clouds sweeping over the stubble when I creep and stand on the front steps after reading all night, and our owls hoot, and everyone's sleeping <i>upstairs</i> [___], sleeping sound, in quiet bedrooms. [BNC: A0U 708]
D	can have adverbial complement	-	
E	can have <i>that</i> -clause complement	-	
F	can have <i>that</i> -less clause complement	-	
G	can have topicalisation	-	
H	can have small clause complement: overt subject & not <i>-ing</i> predicate	-	
I	can have small clause complement: raised subject & <i>-ing</i> predicate	-	
J	can have small clause complement: raised subj & not <i>-ing</i> predicate	-	
K	can occur with complement with correlative <i>or</i>	-	
L	can occur with measure phrase	+	He walked <u>515 feet</u> <i>upstairs</i> . [BNC: DK3 345]



M	can occur with <i>right/straight</i> modifier	+	It was <i>right upstairs</i> above the shop and all the women were nice. [BNC: CK9 276]
N	can undergo particle shift	-	
O	can be predicative complement in RAISING constructions	+	They <i>'re upstairs</i> . [BNC: BMS 3588]
P	can be non-predicative modifier	+	I was now at a bit of a loss as to what to do next, so I wandered <i>upstairs to the room that housed the books covering my subject</i> , just to check up on a few things. [BNC A0F 266]